

hoyer

barcelona lights

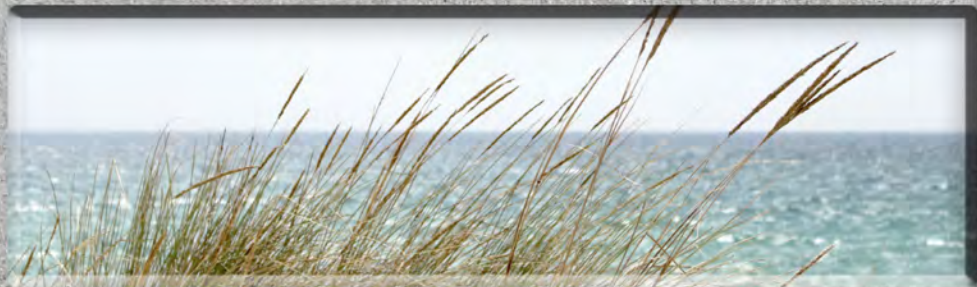

Outdoor book

bover

barcelona lights

Outdoor book

Avda. Catalunya 173
Poligon Ind. Sud
08440 Cardedeu
Barcelona, Spain

T. +34 938 713 152
F. +34 938 462 089
info@bover.es
www.bover.es

1231 Collier Road,
Suite C
Atlanta, GA 30318
United States

T. +1 (404) 924 2342
info@boverusa.com
www.boverusa.com

Apliques Wall Lamps

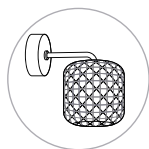

Nans, 32

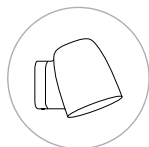

Nut, 64



Platet, 80

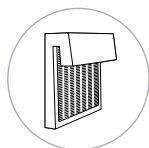

Sisal, 86

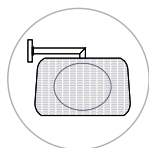

Fora, 120

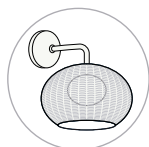

Garota, 145

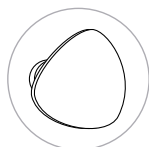

Tria, 174

Plafones Ceiling Lamps



Nans, 30, 42



Nut, 71



Mediterrània, 78

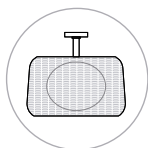

Fora, 131

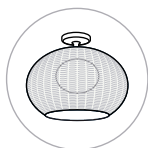

Garota, 143

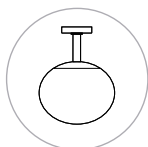

Elipse, 116

Suspensió Pendant Lamps



Nans, 6, 17, 40

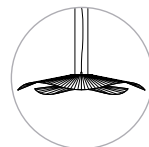

Mediterrània, 74

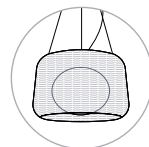

Fora, 128

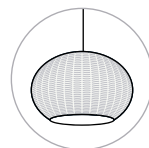

Garota, 134

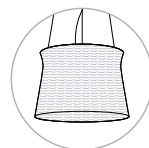

Syra, 154

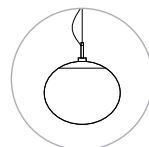

Elipse, 114



Marietta, 180



Maxi, 189

**Mesa
Table Lamps**



Nans, 54



Nans Portable, 46



Tanit, 94

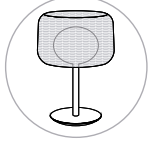

Fora, 122

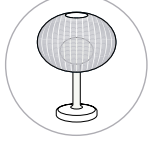

Garota, 136

Hang



Nans, 10

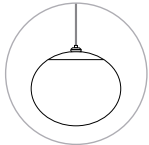

Elipse, 114

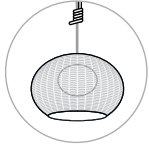

Garota, 134, 144

**Pie
Floor Lamps**

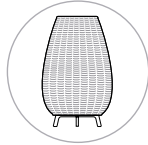

Amphora, 100



Atticus, 111

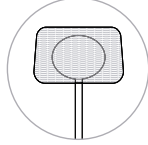

Fora, 124

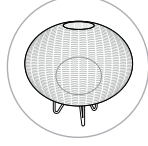

Garota, 137

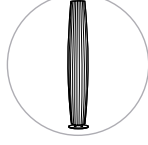

Maxi, 186

**Catenarias
Catenary**

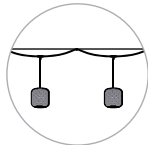

Nans, 12

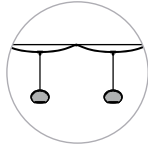

Garota, 141

**Recargables
Battery**



Nans, 54



Nans Portable, 46



Atticus, 111, 113



Tanit, 94

**Balizas
Bollards**

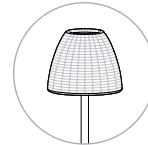

Atticus, 108, 112

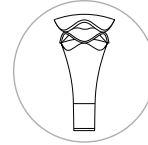

Cornet, 162



Moai, 170



Nuestra historia

La ribera del Mediterráneo fue la cuna del Neolítico en Europa, vio nacer y crecer las primeras grandes civilizaciones.

A lo largo de sus costas, Fenicios, Persas, Egipcios, Griegos y finalmente los Romanos, levantaron sus asentamientos. Y fue así, como nos regalaron siglos y siglos de sabiduría, que pusieron a nuestro alcance, transformando nuestras costumbres y nuestros hábitos.

Culturas ancestrales que mezclándose entre nuestras calles, plazas y mercados, dieron lugar a nuestra historia. Contribuyendo con su saber a crear un nuevo arte, conocimiento y filosofía de vida que aún perdura.

Our story

The Mediterranean shores were the cradle of the Neolithic in Europe where the birth and growth of the first great civilizations took place.

Along its coasts, Phoenicians, Persians, Egyptians, Greeks and finally the Romans made their settlements. Thus they passed on centuries of wisdom which was offered to us to shape our customs and the way we live.

Ancestral cultures that permeated our streets, squares and markets to create our history. Contributing with their enlightenment to the creation of new art, knowledge and a philosophy of life that to this day remains unaltered.

Nans

by Joana Bover | 2021





Cala Nans es una pequeña Cala de Cadaqués, solo accesible por caminos de Ronda o por mar.

Un rincón virgen del Mediterráneo, donde la vegetación y la vigilia de un viejo Faro, hacen de este lugar un espacio natural, donde solo se puede escuchar el sonido del mar y las aves que sobrevuelan la costa.

Con las Nans, hemos querido poner de relieve el trabajo artesanal de sus pantallas, buscar un modo distinto de tejer la trama, combinarla con distintos colores y formatos dando vida a un estilo esencialmente mediterráneo.

Cala Nans is a small cove in Cadaqués accessible only by footpaths or by sea.

An unspoiled corner of the Mediterranean where the vegetation and an old lighthouse's vigil make this place a natural spot where all you can hear are the sound of the sea and of the birds that fly over the coast.

With Nans we wanted to highlight the craftsmanship of the lampshades and to look for a different way of weaving by combining different colours and formats to create a true Mediterranean style.





Nans S/16/H



Nans S/16/H



Nans Catenary S/16/4L



Cultura Mediterránea

A través de los siglos, el mar ha actuado como elemento cohesionador del paisaje y la cultura de sus pueblos. Las personas que vivimos a lo largo de su costa occidental, compartimos un modo de vida abierto al exterior que nos identifica. La esencia de la cultura mediterránea es la riqueza lingüística, la gastronomía y el conocimiento de los oficios.

Mediterranean Culture

Over the centuries, the sea has been the binding element in the landscape and culture of its towns.

Those of us who live along its western shores share a way of life that is characterized by our openness to the outside world. The essence of the Mediterranean culture are its linguistic richness, its cuisine and its skills in the trades.

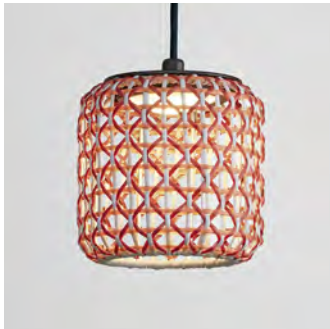

Nans Catenary S/16/4L





Nans S/16/H





Nans S/21 | S/31 | S/31.2





Nans S/3L | Indoor IP-20





Nans S/3L | Indoor IP-20













Nans S/16 | S/21 | S/31 | S/31.2



Nans S/31.2



Nans PF/31





Nans A/02



Nans A/02

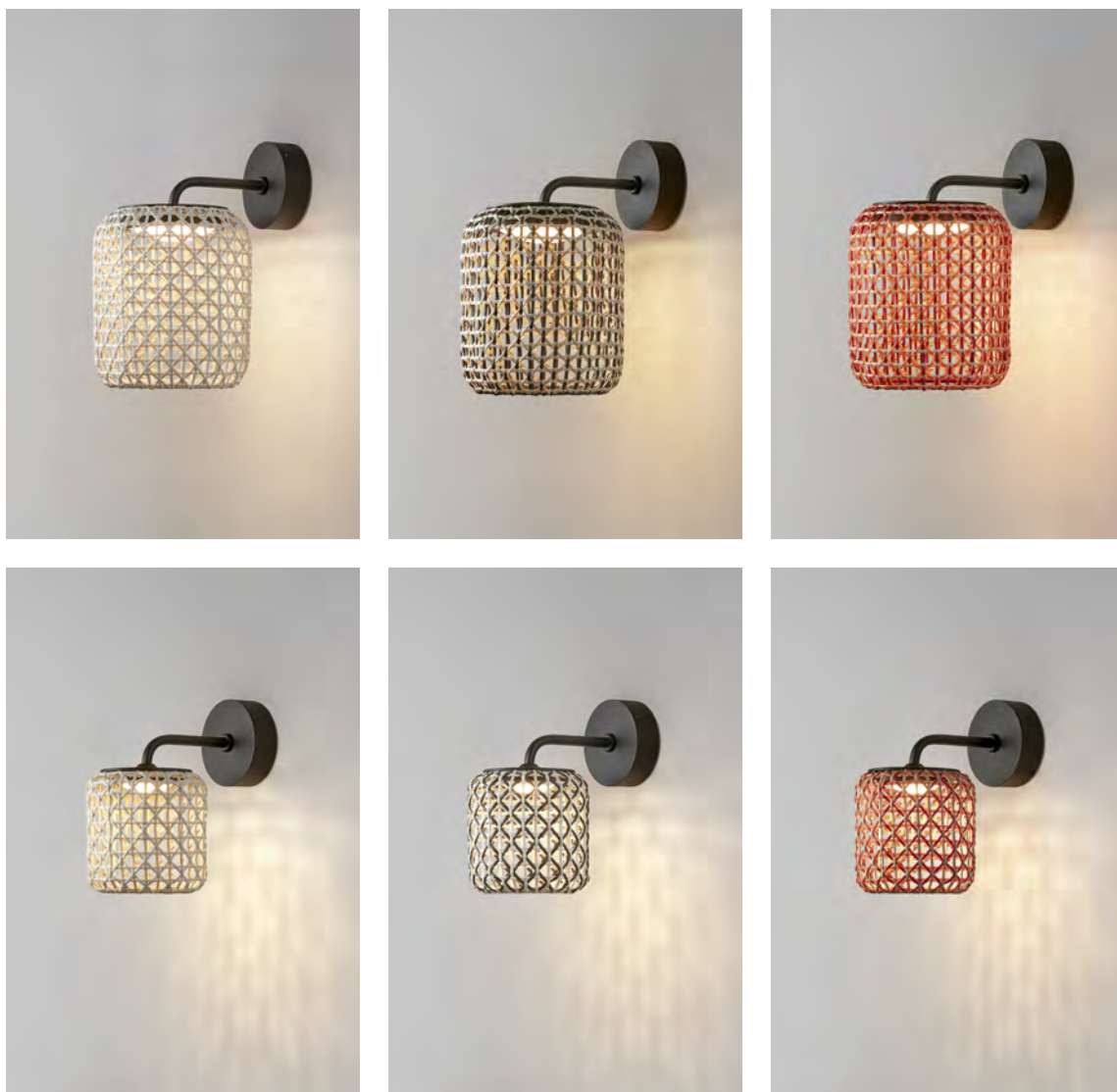

Acabados / Finishing

Sólo para pantallas Nans 31 / Only for Nans 31 shades



Roja / Red



Marrón / Brown

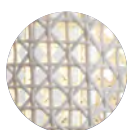

Beige / Beige

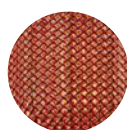

Roja / Red



Marrón / Brown

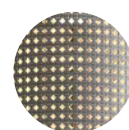

Beige / Beige



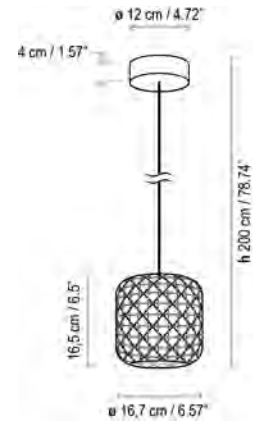
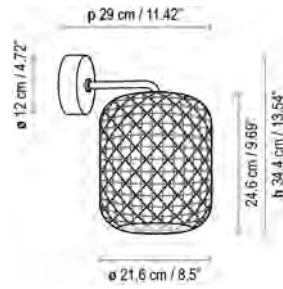
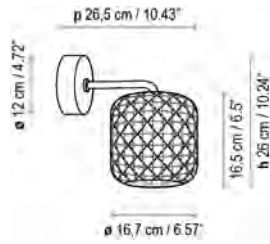

Nans A /01 IP-66

TRIAC | 6 W LED / CRI: 90 / 2700°K
503 lm fuente de luz / *light source*

Nans A /02 IP-66

TRIAC | 9,5 W LED / CRI: 90 / 2700°K
1450 lm fuente de luz / *light source*

Nans S /16 IP-66

TRIAC | 6 W LED / CRI: 90 / 2700°K
503 lm fuente de luz / *light source*

Only for North America

Nans A /01 WET

6 W LED / CRI: 90 / 2700°K
466 lm light source

Nans A /02 WET

9,5 W LED / CRI: 90 / 2700°K
1450 lm light source

Nans S /16 WET

6 W LED / CRI: 90 / 2700°K
466 lm light source

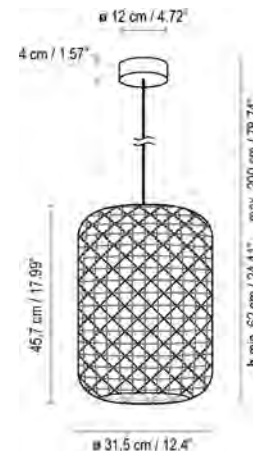
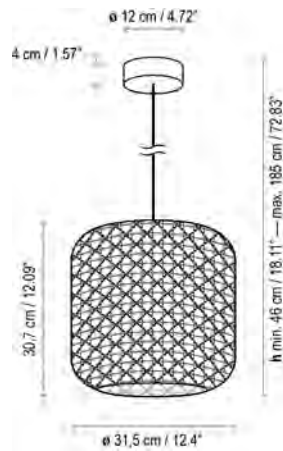
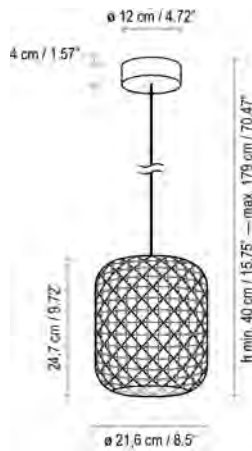

Nans S /21 IP-66

TRIAC | 9,5 W LED / CRI: 90 / 2700°K
1450 lm fuente de luz / *light source*

Nans S /31 IP-66

TRIAC | 9,5 W LED / CRI: 90 / 2700°K
1450 lm fuente de luz / *light source*

Nans S /31.2 IP-66

TRIAC | 9,5 W LED / CRI: 90 / 2700°K
1450 lm fuente de luz / *light source*

Only for North America

Nans S /21 WET

9,5 W LED / CRI: 90 / 2700°K
1450 lm light source

Nans S /31 WET

9,5 W LED / CRI: 90 / 2700°K
1450 lm light source

Nans S /31.2 WET

9,5 W LED / CRI: 90 / 2700°K
1450 lm light source

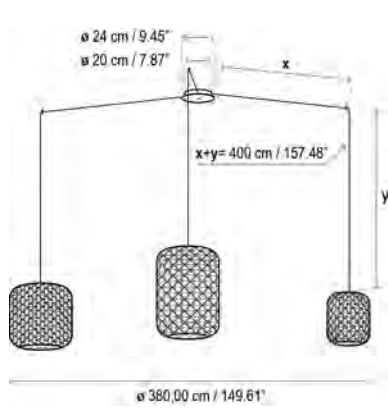

Nans S/3L INDOOR IP-20

3 x 9,5 W LED / CRI: 90 / 2700°K
3 x 1450 lm fuente de luz / light source

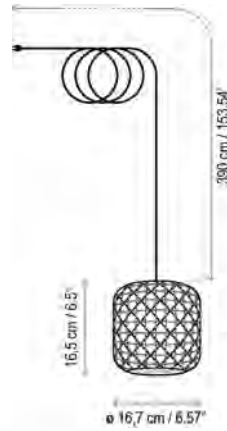

Nans S/16/H IP-66

6 W LED / CRI: 90 / 2700°K
503 lm fuente de luz / light source

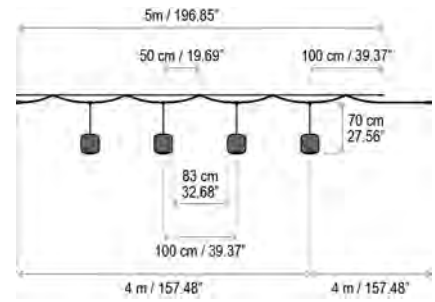

Nans Catenary S/16/4L IP-66

4 x 6 W LED / CRI: 90 / 2700°K
4 x 503 lm fuente de luz / light source

Only for North America

Nans S/3L DRY

3 x 9,5 W LED / CRI: 90 / 2700°K
3 x 1450 lm light source

Nans S/16/H WET

6 W LED / CRI: 90 / 2700°K
466 lm light source

Nans Catenary S/16/4L WET

4 x 6 W LED / CRI: 90 / 2700°K
4 x 466 lm light source

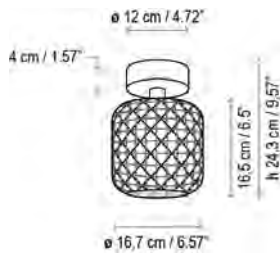

Nans PF/16 IP-66

6 W LED / CRI: 90 / 2700°K
503 lm fuente de luz
light source

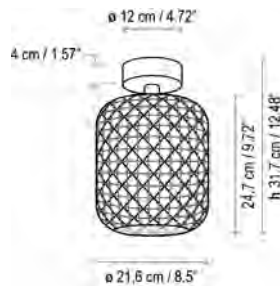

Nans PF/21 IP-66

9,5 W LED / CRI: 90 / 2700°K
1450 lm fuente de luz
light source

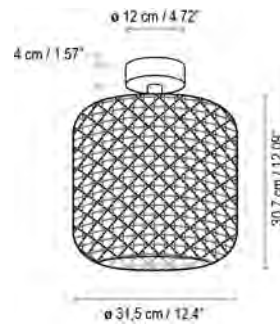

Nans PF/31 IP-66

9,5 W LED / CRI: 90 / 2700°K
1450 lm fuente de luz
light source



Nans PF/31.2 IP-66

9,5 W LED / CRI: 90 / 2700°K
1450 lm fuente de luz
light source

Only for North America

Nans PF/16 WET

6 W LED / CRI: 90 / 2700°K
466 lm light source

Nans PF/21 WET

9,5 W LED / CRI: 90 / 2700°K
1450 lm light source

Nans PF/31 WET

9,5 W LED / CRI: 90 / 2700°K
1450 lm light source

Nans PF/31.2 WET

9,5 W LED / CRI: 90 / 2700°K
1450 lm light source

Quizás porque somos del mediterráneo;
el outdoor es uno de los campos en los que Bover
es más conocida.

El denominador común de esta colección
es la combinación de resistencia y sensibilidad.
Resistencia ya que está diseñada para poder vivir
cómodamente a la intemperie, y sensibilidad
expresada en la delicadeza con que tamiza la luz
y la calidez general de la lámpara. Estas características
hacen que tanto dentro como fuera de un espacio
arquitectónico, ayuden a crear una sensación
de continuidad.



It is probably because we come from the Mediterranean that the outdoors is one of the areas for which Bover is best known.

This collection's common denominator is the combination of resistance and sensitivity. Resistance because it is designed to be able to stay happily outdoors, and its sensitivity shows in the delicacy with which it filters the light and the overall warmth of the lamp. These features help to create a sense of continuity both on the inside and outside of an architectural space.





Nans Sphere S/60 | S/80

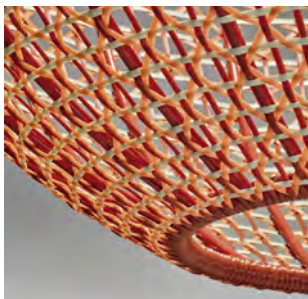

Roja / Red



Marrón / Brown

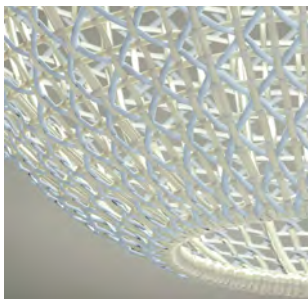

Beige / Beige

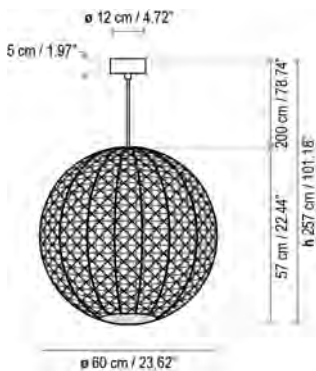

Nans Sphere S/60 IP-66

TRIAC 14 W LED / CRI: 90 / 2700°K
1400 lm fuente de luz / light source

Only for North America

Nans Sphere S/60 WET

14 W LED / CRI: 90 / 2700°K
1400 lm light source

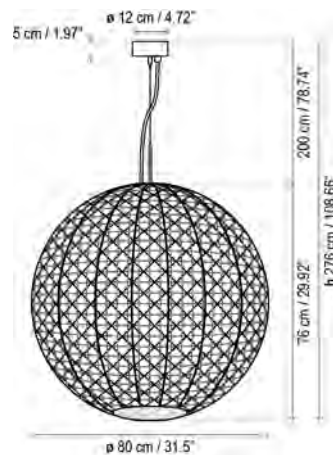

Nans Sphere S/80 IP-66

TRIAC 24 W LED / CRI: 90 / 2700°K
2400 lm fuente de luz / light source

Nans Sphere S/80 WET

24 W LED / CRI: 90 / 2700°K
2400 lm light source



NansSphere PE/60

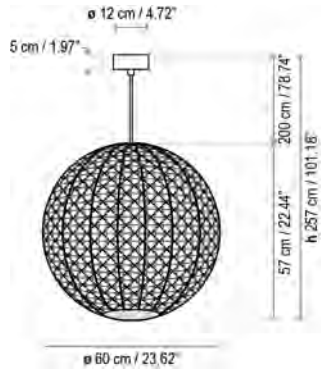

Nans Sphere PF/60 IP-66

  14 W LED / CRI: 90 / 2700°K
1400 lm fuente de luz / light source

Only for North America

Nans Sphere PF/60 WET

   14 W LED / CRI: 90 / 2700°K
1400 lm light source

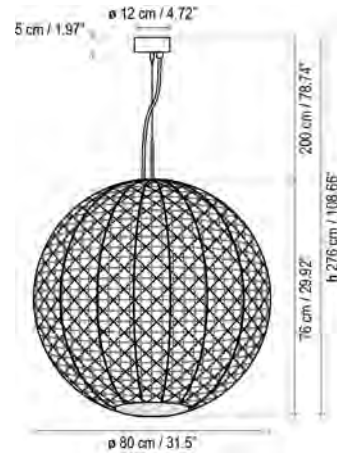

Nans Sphere PF/80 IP-66

  24 W LED / CRI: 90 / 2700°K
2400 lm fuente de luz / light source

Nans Sphere PF/80 WET

   24 W LED / CRI: 90 / 2700°K
2400 lm light source



Nans



NansPortable

by Joana Bover | 2021

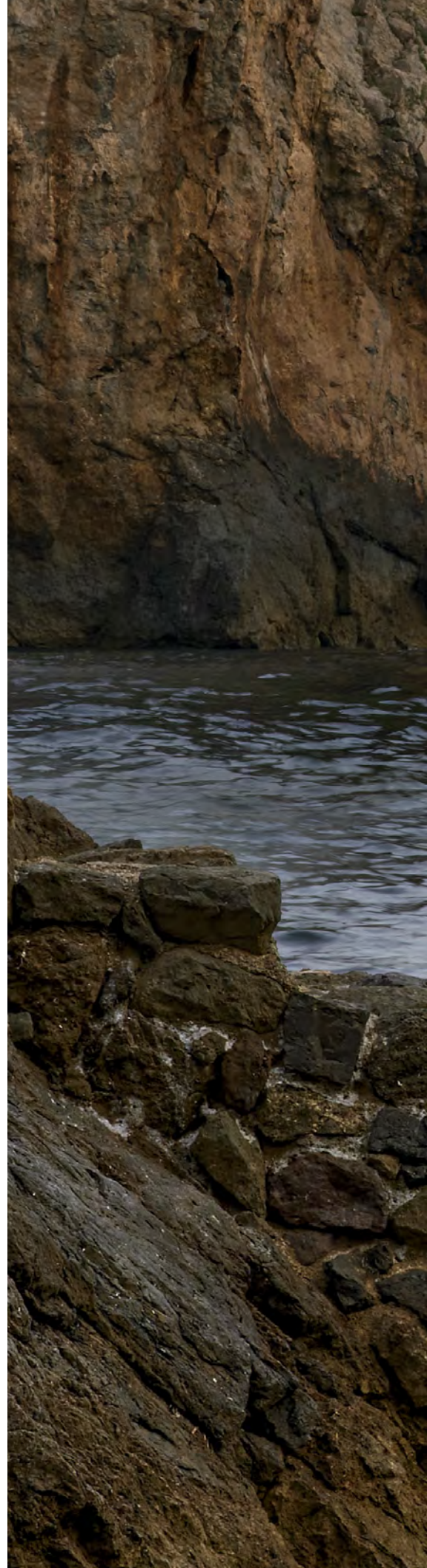





Nans Portable M/41/R | M/49/R | Battery





Nans Portable M/49/R | Battery

Mare Nostrum
Mediterráneo
Nuestro mar

A veces me pregunto, qué hace que este mar
sea tan especial para todos los que vivimos en su ribera.
¿Ocurre lo mismo en todos los mares?

Para los que vivimos a orillas del Mediterráneo,
el mar, es nuestra visión infinita de las cosas y de la vida.
Es nuestro universo, el punto desde el que partimos
y al que siempre queremos regresar.

*Mare Nostrum
Mediterranean
Our sea*

*Sometimes I wonder what makes this sea
so special to all of us who live on its shores.
Does the same hold true for all seas?*

*For those of us who live on the shores of the Mediterranean,
the sea is our infinite vision of things and life.
It is our universe, the point from where we start
and where we always seek to return.*



Nans Portable M/41 | M/49



Nans Portable M/49/R | Battery



Nans M/21/R | Indoor | Battery



Nans M/21/R | Indoor | Battery

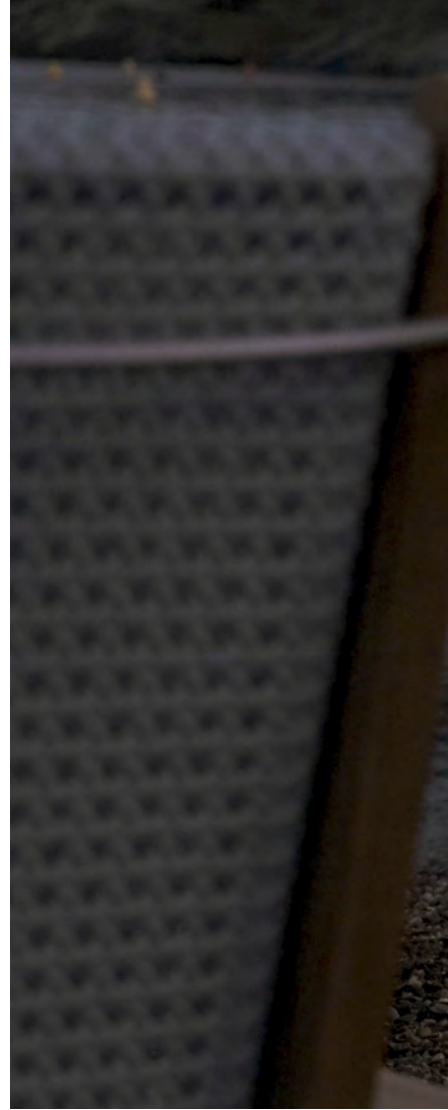

Nans M/21/R IP-20

 3 W LED / CRI: 90 / 2700°K
 460 lm fuente de luz / light source

Only for North America

Nans M/21/R DRY

 3 W LED / CRI: 90 / 2700°K
 460 lm light source

Nans M/21/R | Indoor | Battery

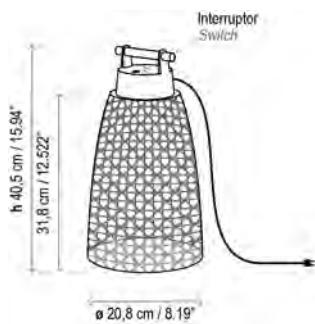

Nans Portable M/41 IP-65

6,3 W LED / CRI: 90 / 2700°K
950 lm fuente de luz / *light source*

Only for North America

Nans Portable M/41 WET

6,3 W LED / CRI: 90 / 2700°K
950 lm light source



Nans Portable M/41/R IP-65

3 W LED / CRI: 90 / 2700°K
460 lm fuente de luz / *light source*

Nans Portable M/41/R WET

3 W LED / CRI: 90 / 2700°K
460 lm light source

Nans Portable M/41/R | Battery

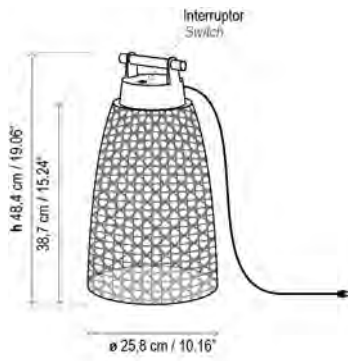

Nans Portable M/49 IP-65

⊙ 6,3 W LED / CRI: 90 / 2700°K
950 lm fuente de luz / *light source*

Only for North America

Nans Portable M/49 WET

⊙ 6,3 W LED / CRI: 90 / 2700°K
950 lm light source



Nans Portable M/49/R IP-65

⊙ 3 W LED / CRI: 90 / 2700°K
460 lm fuente de luz / *light source*

Nans Portable M/49/R WET

⊙ 3 W LED / CRI: 90 / 2700°K
460 lm light source









Nans Portable M/49/R | Battery





Nut

by Estudi Manel Molina | 2021

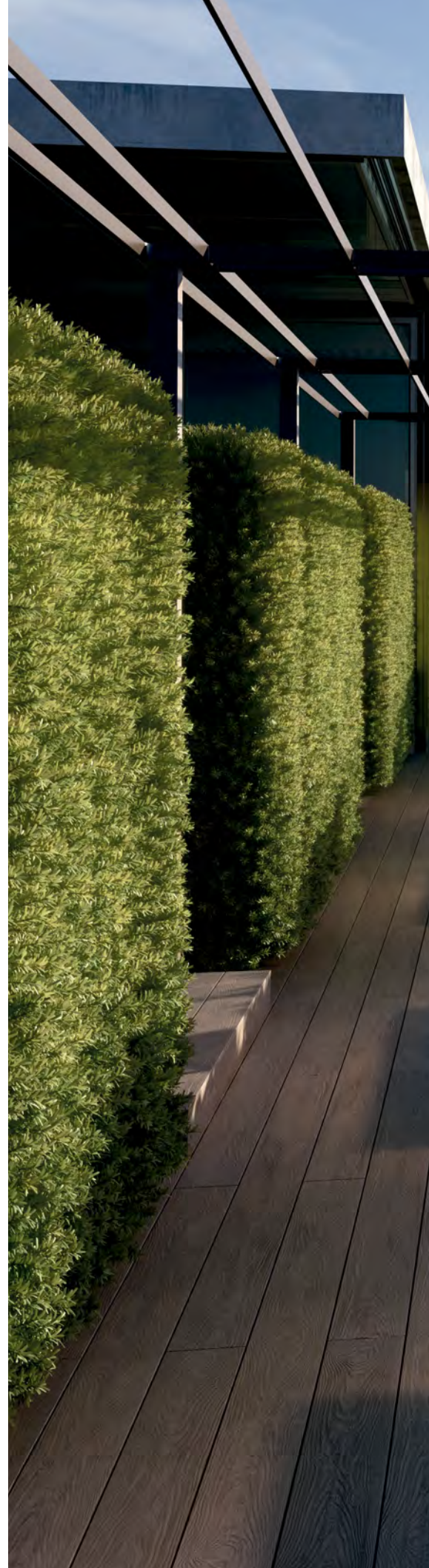



Las Nut se caracterizan por su cuerpo ergonómico y contundente. Son un producto altamente versátil, su manejo es fácil e intuitivo y pueden orientarse 180°. Pueden instalarse en ambientes Indoor y Outdoor.

The Nut collection is characterized by their ergonomic and solid build. They are a highly versatile product. Their handling is easy and intuitive, and they can be positioned 180°. They can be used both for Indoor as well as Outdoor environments.



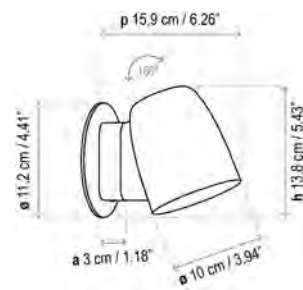
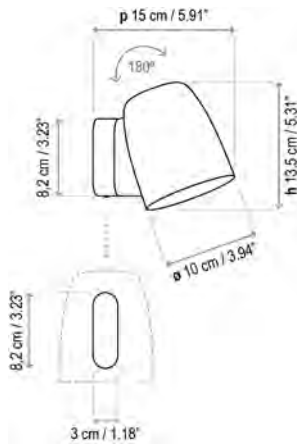

Nut A/01 IP-66

  6,3 W LED / CRI: 90 / 2700°K
950 lm fuente de luz / light source

Only for North America

Nut A/01 WET

   6,3 W LED / CRI: 90 / 2700°K
950 lm light source

Image does not show north American backplate



Negro / Black



Teja / Terracotta



Blanco / White



Gris claro / Light grey





Nut A/01





Nut PF/10 IP-66



6,3 W LED / CRI: 90 / 2700°K
950 lm fuente de luz / light source

Only for North America

Nut PF/10 WET



6,3 W LED / CRI: 90 / 2700°K
950 lm light source

Image does not show north American backplate

Nut PF/10



Mediterrània

by Alex Fernández Camps | 2019





Mediterrània S/105



Naturaleza, tradición, diseño y tecnología
son la base de nuestros productos

*Nature, tradition, design and technology
are the foundation of our products*





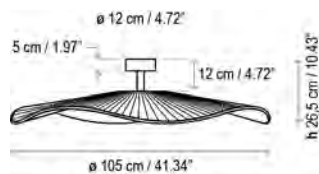

Mediterrània PF/105 IP-66



17,1 W LED / CRI: 90 / 2700°K
2064 lm fuente de luz / light source

Mediterrània S/105 IP-66



17,1 W LED / CRI: 90 / 2700°K
2064 lm fuente de luz / light source

Only for North America

Mediterrània PF/105 WET



17,1 W LED / CRI: 90 / 2700°K
2064 lm light source

Mediterrània S/105 WET



17,1 W LED / CRI: 90 / 2700°K
2064 lm light source



Mediterrània PF/105

Platet

by Christophe Mathieu | 2020

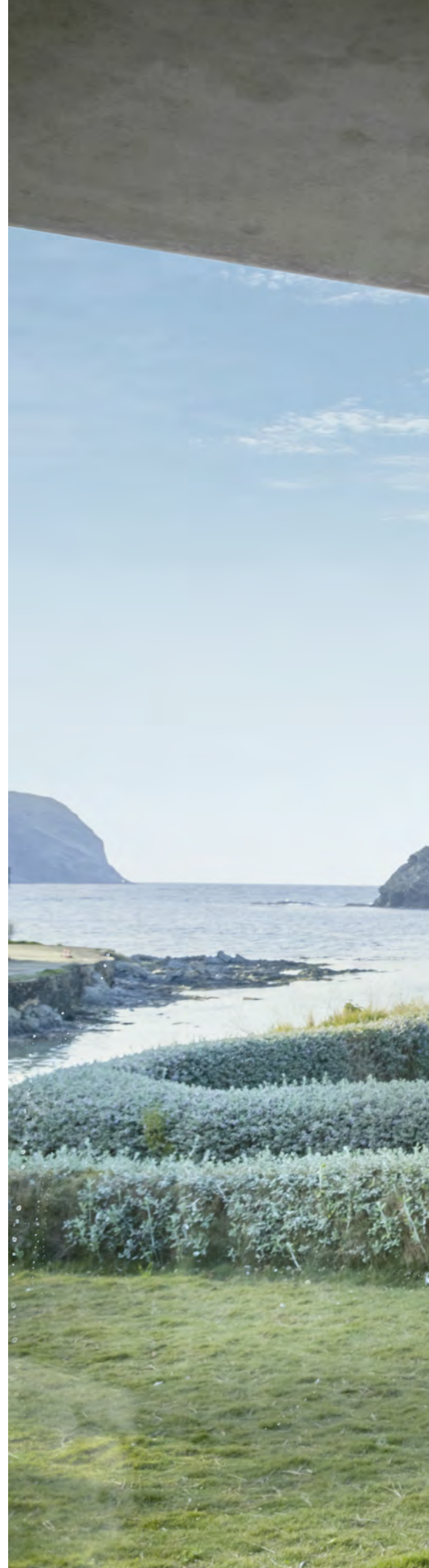



Platet A/02 / Indoor



Platet A/01 / Outdoor



Formas simples, que nos resultan familiares y nos hacen viajar a través del tiempo. Adaptado a la fuente de luz LED, hay algo de romántico en la Platet. La paleta de color incorpora tonos sobrios y cálidos, siempre con la parte interior de la pantalla de color blanco que nos proporciona una buena calidad de luz.

Simple shapes that have a familiar feeling and make us travel through time. There is something romantic about the LED adapted Platet. Its colour palette includes sober and warm tones and the inner side of the lampshade is always white for good light quality.



Marrón / Brown



Verde / Green



Negro / Black



Platet A/01 Outdoor / Custom length

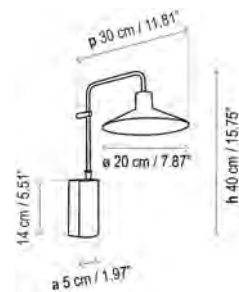

Platet A/01 IP66

4,2 W LED / CRI: 90 / 2700°K
504 lm fuente de luz / light source



Only for North America

Platet A/01 WET

4,2 W LED / CRI: 90 / 2700°K
504 lm light source

Sisal

by Joana Bover | 2019







Sisal A/01



Sisal A/01

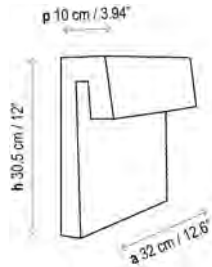
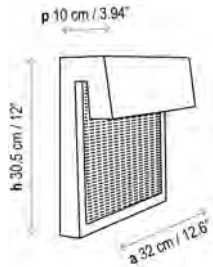

Sisal A/01 IP66



9,1 W LED / CRI: 90 / 2700°K
990 lm fuente de luz / light source

Only for North America

Sisal A/01 WET



9,1 W LED / CRI: 90 / 2700°K
990 lm light source

Acabados / Finishing



Frontal Metal Marrón
Brown Metal Frontal



Frontal Fibra Marrón
Brown Fiber Frontal

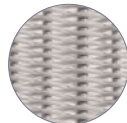

Frontal Fibra Beige Claro
Light Beige Fiber Frontal







Sisal A/01



Tanit

by Gonzalo Milà | 2019

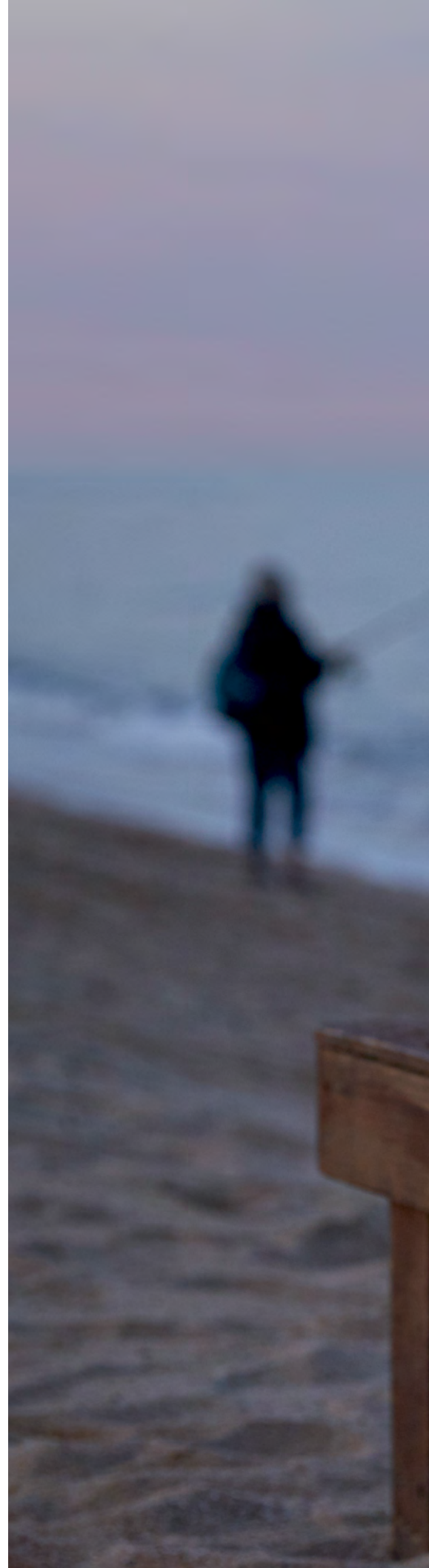





Tanit M/29/R IP20

1,5 W LED / CRI: 80 / 2700°K
54 lm fuente de luz / light source

Only for North America

Tanit M/29/R DRY

1,5 W LED / CRI: 80 / 2700°K
54 lm light source



Tanit M/29/R | Indoor | Battery

Tanit es una lámpara de sobremesa portátil y recargable, de luz suave y tamizada por una pantalla tejida de forma artesanal con hilo de algodón.

Tanit is a portable and rechargeable table lamp that gives out a soft light filtered through a handwoven cotton thread lampshade.





Tanit M/29/R | Indoor | Battery



Amphora

by Alex Fernández Camps / Gonzalo Milà | 2013





Amphora



Sus grandes volúmenes y formas rinden un sutil y discreto homenaje a las ánforas de terracota que antiguamente se utilizaban para almacenar alimentos.

The size and shape of this collection pay a subtle and discreet homage to the terracotta amphoras used once upon a time to store food.



Amphora 03





Opciones LED consultar dibujo
técnico en la ficha técnica

LED options consult technical
drawing in the cutsheet

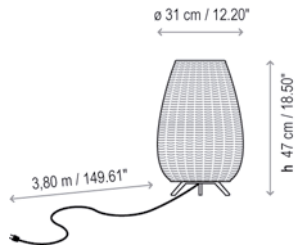

Amphora IP-66

8 W LED / CRI: 90 / 2700°K
642 lm fuente de luz / *light source*

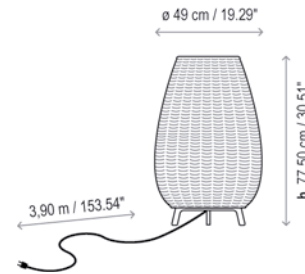

Amphora 01 IP-66

2 x 22 W CFL E-27
2 x 9 W LED E-27 A60
17,1 W LED / CRI: 90 / 2700°K
2064 lm fuente de luz / *light source*
TRIAC | 17,1 W LED / CRI: 90 / 2700°K
2064 lm fuente de luz / *light source*

Only for North America

Amphora WET

8 W LED / CRI: 90 / 2700°K
622 lm light source

Amphora 01 WET

2 x 10 W E26 LED A19
0-10V | TRIAC | 17,1 W LED / CRI: 90 / 2700°K
2064 lm light source

Opciones LED consultar dibujo técnico en la ficha técnica

LED options consult technical drawing in the cutsheet

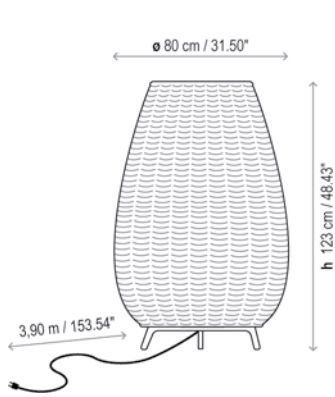



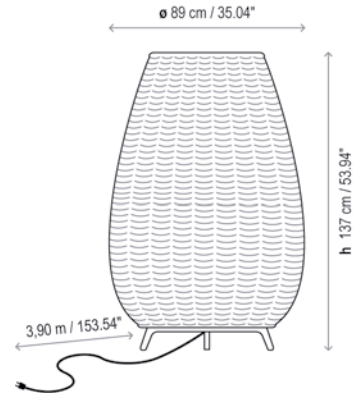

Opciones LED consultar dibujo técnico en la ficha técnica





LED options consult technical drawing in the cutsheet



Amphora 02 IP-66





-  2 x 30 W CFL E-27
-  2 x 9 W LED E-27 A60
-  24,7 W LED / CRI: 90 / 2700°K
3000 lm fuente de luz / light source
-   24,7 W LED / CRI: 90 / 2700°K
3000 lm fuente de luz / light source

Amphora 03 IP-66





-  2 x 30 W CFL E-27
-  2 x 9 W LED E-27 A60
-  24,7 W LED / CRI: 90 / 2700°K
3000 lm fuente de luz / light source
-   24,7 W LED / CRI: 90 / 2700°K
3000 lm fuente de luz / light source

Only for North America

Amphora 02 WET

-  2 x 10 W E26 LED A19
-    24,7 W LED / CRI: 90 / 2700°K
3000 lm light source

Amphora 03 WET

-  2 x 10 W E26 LED A19
-    24,7 W LED / CRI: 90 / 2700°K
3000 lm light source

Acabados / Finishing



Marrón Grafito
Graphite Brown



Beige Claro
Light Beige



Marrón Rattan
Rattan Brown

Atticus

by Joana Bover | 2017

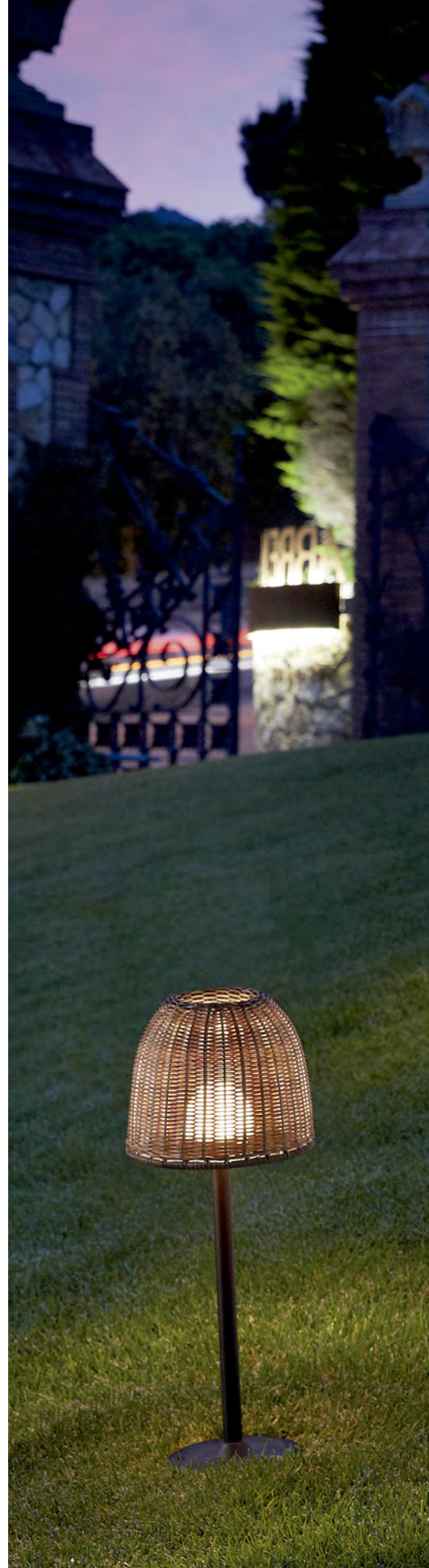



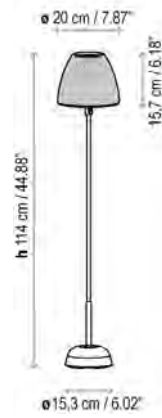
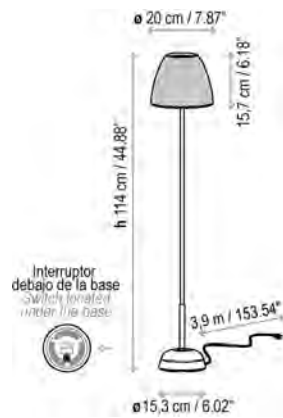

Atticus B/56 - B/66 IP-66

  8,4 W LED / CRI: 90 / 2700°K
1122 lm fuente de luz / light source

Atticus P/114 IP-66

 8,4 W LED / CRI: 90 / 2700°K
1122 lm fuente de luz / light source

Atticus P/114/R IP-66

 3,2 W LED / CRI: 90 / 2700°K
400 lm fuente de luz / light source

Only for North America

Atticus B/56 - B/66 WET

  8,4 W LED / CRI: 90 / 2700°K
1122 lm light source

Atticus P/114 WET

 8,4 W LED / CRI: 90 / 2700°K
1122 lm light source

Atticus P/114/R WET

 3,2 W LED / CRI: 90 / 2700°K
400 lm light source

Acabados / Finishing



Blanco Roto
Natural White



Marrón Grafito
Graphite Brown



Beige Claro
Light Beige



Marrón Rattan
Rattan Brown



Atticus P/114/R | Battery



Atticus B/56 | B/66



Atticus P/114 | P/114/R | Battery

Elipse

by Alex Fernández Camps / Gonzalo Milà | 2013





Elipse S/30/H | S/50/H



Eclipse PF/30

Elipse outdoor es una solución sencilla, libre y flexible en su aplicación. Puede actuar de sobremesa colgada de una rama durante una cena, iluminar un rincón de un jardín junto a una hamaca, o crear una atmósfera mágica con un conjunto de Elipses suspendidas en la noche. La belleza de la sencillez.

Elipse outdoor is a simple, unrestrained and versatile product. It can be hung from a branch over a table for a dinner, to light a garden corner by a hammock or to create a magical atmosphere with a set of ellipses hanging in the night. The beauty of simplicity.

Opciones LED consultar dibujo técnico en la ficha técnica

LED options consult technical drawing in the cutsheet

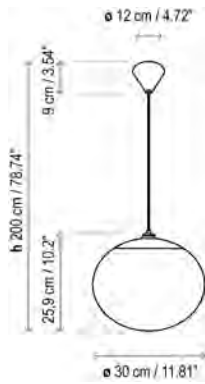

Opciones LED consultar dibujo técnico en la ficha técnica

LED options consult technical drawing in the cutsheet

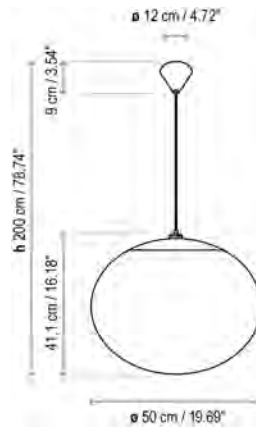

Opciones LED consultar dibujo técnico en la ficha técnica

LED options consult technical drawing in the cutsheet

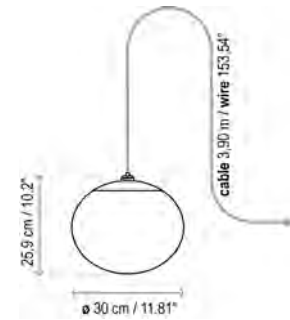

Elipse S/30 IP-66

2 x 14 W CFL E-27

2 x 6 W LED E-27 P45

17,1 W LED / CRI: 90 / 2700°K
2064 lm fuente de luz / light source

Elipse S/50 IP-66

2 x 14 W CFL E-27

2 x 6 W LED E-27 P45

24,7 W LED / CRI: 90 / 2700°K
3000 lm fuente de luz / light source

Elipse S/30/H IP-66

2 x 14 W CFL E-27

2 x 6 W LED E-27 P45

17,1 W LED / CRI: 90 / 2700°K
2064 lm fuente de luz / light source

Only for North America

Elipse S/30 WET

2 x 10 W E26 LED A19

17,1 W LED / CRI: 90 / 2700°K
2064 lm light source

Elipse S/50 WET

2 x 10 W E26 LED A19

24,7 W LED / CRI: 90 / 2700°K
3000 lm light source

Elipse S/30/H WET

2 x 10 W E26 LED A19

Opciones LED consultar dibujo técnico en la ficha técnica

LED options consult technical drawing in the cutsheet

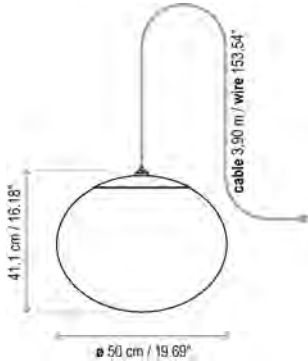

Opciones LED consultar dibujo técnico en la ficha técnica

LED options consult technical drawing in the cutsheet



Opciones LED consultar dibujo técnico en la ficha técnica

LED options consult technical drawing in the cutsheet

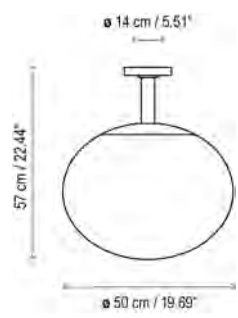

Elipse S/50/H IP-66

2 x 14 W CFL E-27

2 x 6 W LED E-27 P45

24,7 W LED / CRI: 90 / 2700°K
3000 lm fuente de luz / light source

Elipse PF/30 IP-66

2 x 14 W CFL E-27

2 x 6 W LED E-27 P45

17,1 W LED / CRI: 90 / 2700°K
2064 lm fuente de luz / light source

Elipse PF/50 IP-66

2 x 14 W CFL E-27

2 x 6 W LED E-27 P45

24,7 W LED / CRI: 90 / 2700°K
3000 lm fuente de luz / light source

Only for North America

Elipse S/50/H WET

2 x 10 W E26 LED A19

Elipse PF/30 WET

2 x 10 W E26 LED A19

17,1 W LED / CRI: 90 / 2700°K
2064 lm light source

Elipse PF/50 WET

2 x 10 W E26 LED A19

24,7 W LED / CRI: 90 / 2700°K
3000 lm light source

Acabados / Finishing



Blanco Roto
Natural White



Blanco
White

Fora

by Alex Fernández Camps / Gonzalo Milà | 2013

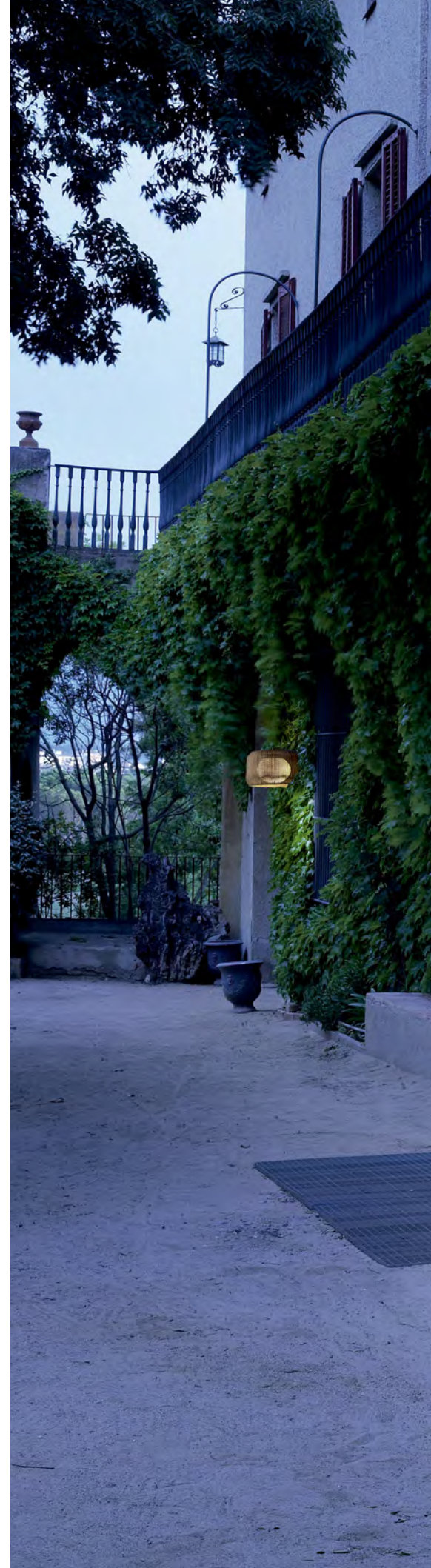





Fora M





Fora P



Fora P



Hotel Gran Meliá Mar
Illetes / Mallorca











Opciones LED consultar dibujo técnico en la ficha técnica

LED options consult technical drawing in the cutsheet

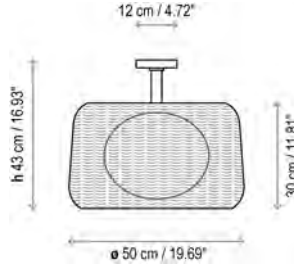
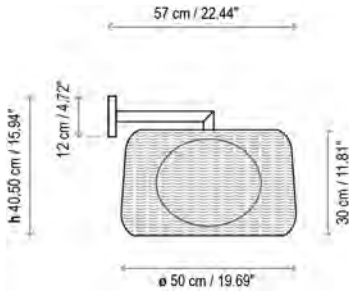

Opciones LED consultar dibujo técnico en la ficha técnica

LED options consult technical drawing in the cutsheet

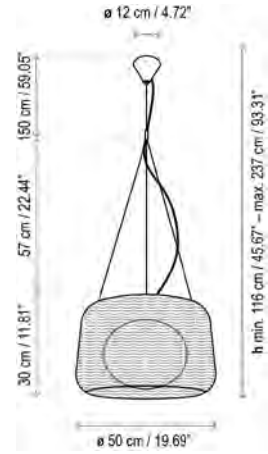

Fora A IP-66

2 x 22 W CFL E-27

2 x 9 W LED E-27 A60

17,1 W LED / CRI: 90 / 2700°K
2064 lm fuente de luz / light source

Fora PF IP-66

2 x 22 W CFL E-27

2 x 9 W LED E-27 A60

17,1 W LED / CRI: 90 / 2700°K
2064 lm fuente de luz / light source

Fora S IP-66

2 x 22 W CFL E-27

2 x 9 W LED E-27 A60

17,1 W LED / CRI: 90 / 2700°K
2064 lm fuente de luz / light source

Only for North America

Fora A WET

2 x 10 W E26 LED A19

17,1 W LED / CRI: 90 / 2700°K
2064 lm light source

Fora PF WET

2 x 10 W E26 LED A19

17,1 W LED / CRI: 90 / 2700°K
2064 lm light source

Fora S WET

2 x 10 W E26 LED A19

17,1 W LED / CRI: 90 / 2700°K
2064 lm light source

Opciones LED consultar dibujo técnico en la ficha técnica

LED options consult technical drawing in the cutsheet

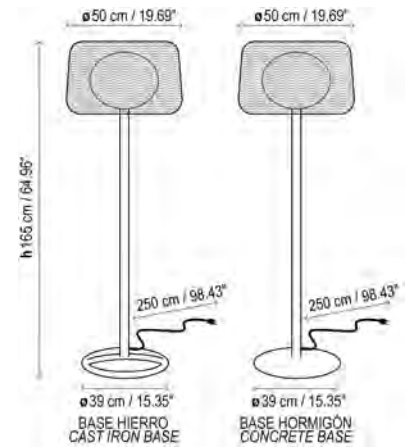
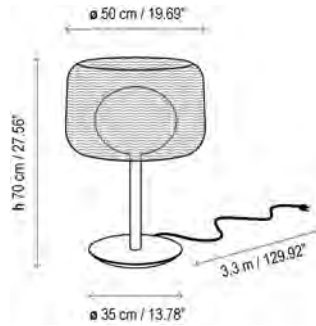
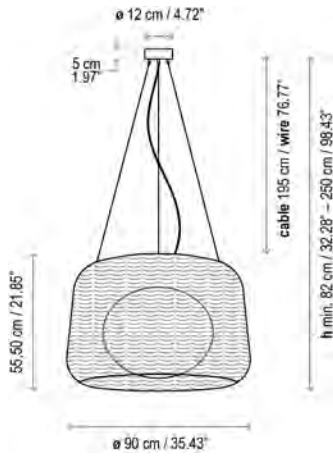

Fora 90 IP-66

2 x 30 W CFL E-27

2 x 9 W LED E-27 A60

24,7 W LED / CRI: 90 / 2700°K
3000 lm fuente de luz / light source

Fora M IP-66

2 x 22 W CFL E-27

2 x 9 W LED E-27 A60

17,1 W LED / CRI: 90 / 2700°K
2064 lm fuente de luz / light source

Fora P IP-66

2 x 22 W CFL E-27

2 x 9 W LED E-27 A60

17,1 W LED / CRI: 90 / 2700°K
2064 lm fuente de luz / light source

Only for North America

Fora 90 WET

2 x 10 W E26 LED A19

24,7 W LED / CRI: 90 / 2700°K
3000 lm light source

Fora M WET

2 x 10 W E26 LED A19

Fora P WET

2 x 10 W E26 LED A19

Acabados / Finishing



Blanco Roto
Natural White



Marrón Grafito
Graphite Brown



Beige Claro
Light Beige



Marrón Rattan
Rattan Brown

Garota

by Alex Fernández Camps / Gonzalo Milà | 2013







Garota M/36









Garota, inspirada en el caparazón de un erizo de mar, nos ofrece una luz cálida y tamizada, envuelta en formas orgánicas, redondeadas y sutiles, pensada para acompañarnos en zonas de interior y exterior indistintamente.

Garota, inspired by the shell of a sea urchin, offers a warm and diffused light, wrapped in organic, rounded and subtle shapes, designed to be with us either indoors or outdoors.





Diseño atemporal,
identidad mediterránea.
Una mirada distinta,
sobre los objetos cotidianos
que nos rodean.

*Timeless design,
Mediterranean identity.
A different look
at the everyday objects
that surround us.*





GarotaHang



GarotaA/01



Glamp 2016, Zion Natural Park / United States
Photographed by Charlie Simmons











Garota A/01 IP-66

8,4 W LED / CRI: 90 / 2700°K
1122 lm fuente de luz / light source



Garota PF/01 IP-66

8,4 W LED / CRI: 90 / 2700°K
1122 lm fuente de luz / light source



Garota PF/02 IP-66

2 x 22 W CFL E-27
 2 x 9 W LED E-27 A60
 17,1 W LED / CRI: 90 / 2700°K
2064 lm fuente de luz / light source

Only for North America

Garota A/01 WET

8,4 W LED / CRI: 90 / 2700°K
1122 lm light source

Garota PF/01 WET

8,4 W LED / CRI: 90 / 2700°K
1122 lm light source

Garota PF/02 WET

2 x 10 W E26 LED A19
 17,1 W LED / CRI: 90 / 2700°K
2064 lm light source

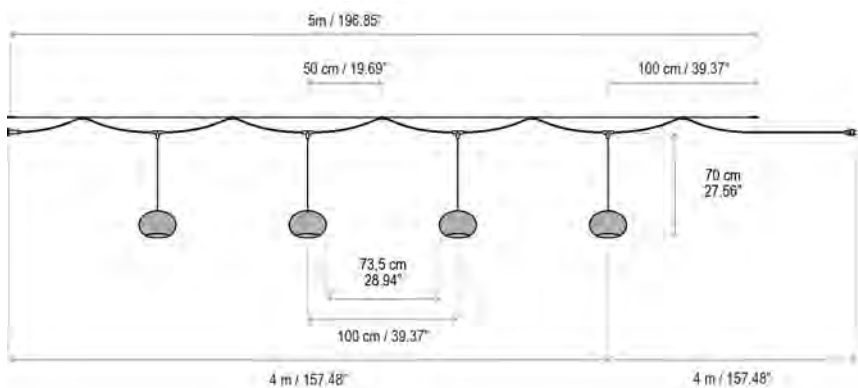

Garota Catenary S/27/4L IP-66

4 x 6 W LED / CRI: 90 / 2700°K
4 x 503 lm fuente de luz / light source

Only for North America

Garota Catenary S/27/4L

4 x 6 W LED / CRI: 90 / 2700°K
4 x 466 lm light source

Opciones LED consultar dibujo
técnico en la ficha técnica

LED options consult technical
drawing in the cutsheet

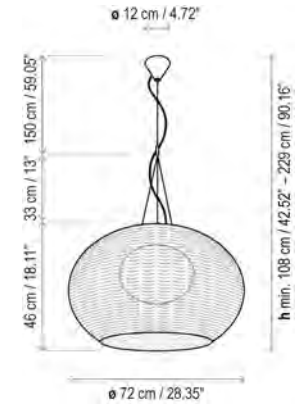
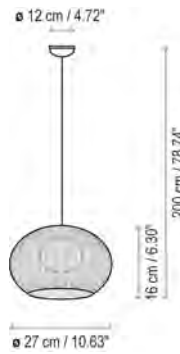
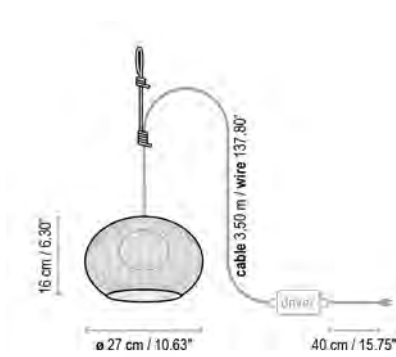

Garota Hang IP-66

8,4 W LED / CRI: 90 / 2700°K
1122 lm fuente de luz / light source

Garota S/01 IP-66

8,4 W LED / CRI: 90 / 2700°K
1122 lm fuente de luz / light source

Garota S/02 IP-66

2 x 22 W CFL E-27

2 x 9 W LED E-27 A60

17,1 W LED / CRI: 90 / 2700°K
2064 lm fuente de luz / light source

Only for North America

Garota Hang WET

8,4 W LED / CRI: 90 / 2700°K
1122 lm light source

Garota S/01 WET

8,4 W LED / CRI: 90 / 2700°K
1122 lm light source

Garota S/02 WET

2 x 10 W E26 LED A19

17,1 W LED / CRI: 90 / 2700°K
2064 lm light source

Opciones LED consultar dibujo técnico en la ficha técnica

LED options consult technical drawing in the cutsheet

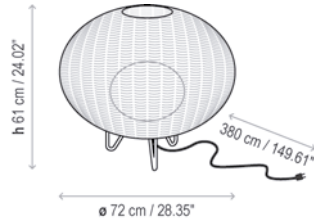
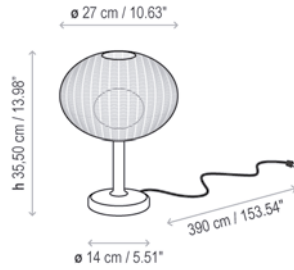

Opciones LED consultar dibujo técnico en la ficha técnica

LED options consult technical drawing in the cutsheet



Garota M/36 IP-66

8,4 W LED / CRI: 90 / 2700°K
1122 lm fuente de luz / light source

Garota P/01 IP-66

2 x 22 W CFL E-27

2 x 9 W LED E-27 A60

17,1 W LED / CRI: 90 / 2700°K
2064 lm fuente de luz / light source

17,1 W LED / CRI: 90 / 2700°K
2064 lm fuente de luz / light source

Garota P/02 IP-66

2 x 22 W CFL E-27

2 x 9 W LED E-27 A60

17,1 W LED / CRI: 90 / 2700°K
2064 lm fuente de luz / light source

17,1 W LED / CRI: 90 / 2700°K
2064 lm fuente de luz / light source

Only for North America

Garota Hang WET

8,4 W LED / CRI: 90 / 2700°K
1122 lm light source

Garota S/01 WET

2 x 10 W E26 LED A19

Garota S/02 WET

2 x 10 W E26 LED A19

Acabados / Finishing



Blanco Roto
Natural White



Marrón Grafito
Graphite Brown

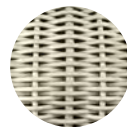

Blanco Marfil
Ivory White



Marrón
Brown

Syra

by Alex Fernández Camps / Gonzalo Milà | 2014





Las Syra son productos ideales para espacios que necesiten luz cálida y elementos amables que ofrezcan buenas dosis de confort.

Syra are ideal products for places that need warm light and friendly elements that offer plenty of comfort.

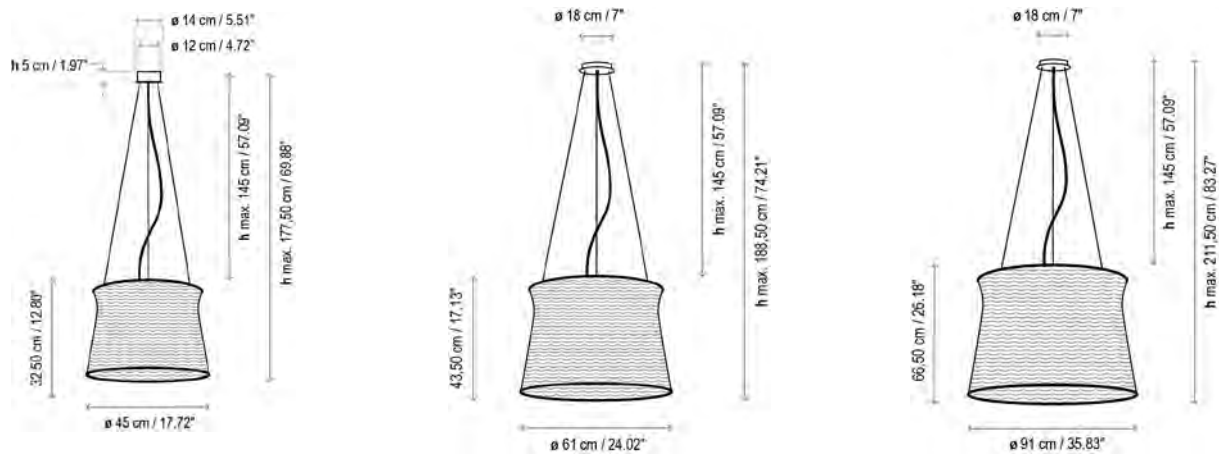

Syra 45 IP-66

  17,1 W LED / CRI: 90 / 2700°K
2064 lm fuente de luz / light source

Syra 60 IP-66

  37,7 W LED / CRI: 90 / 2700°K
4700 lm fuente de luz / light source



Syra 90 IP-66

  39,7 W LED / CRI: 90 / 2700°K
5500 lm fuente de luz / light source

Only for North America

NOT AVAILABLE FOR NORTH AMERICA

Syra 60 WET

  37,7 W LED / CRI: 90 / 2700°K
4700 lm light source

Syra 90 WET

  39,7 W LED / CRI: 90 / 2700°K
5500 lm light source

Acabados / Finishing



Blanco Roto
Natural White



Marrón Grafito
Graphite Brown

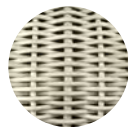

Blanco Marfil
Ivory White



Marrón
Brown





Syra 45







Cornet

by Alex Fernández Camps | 2017

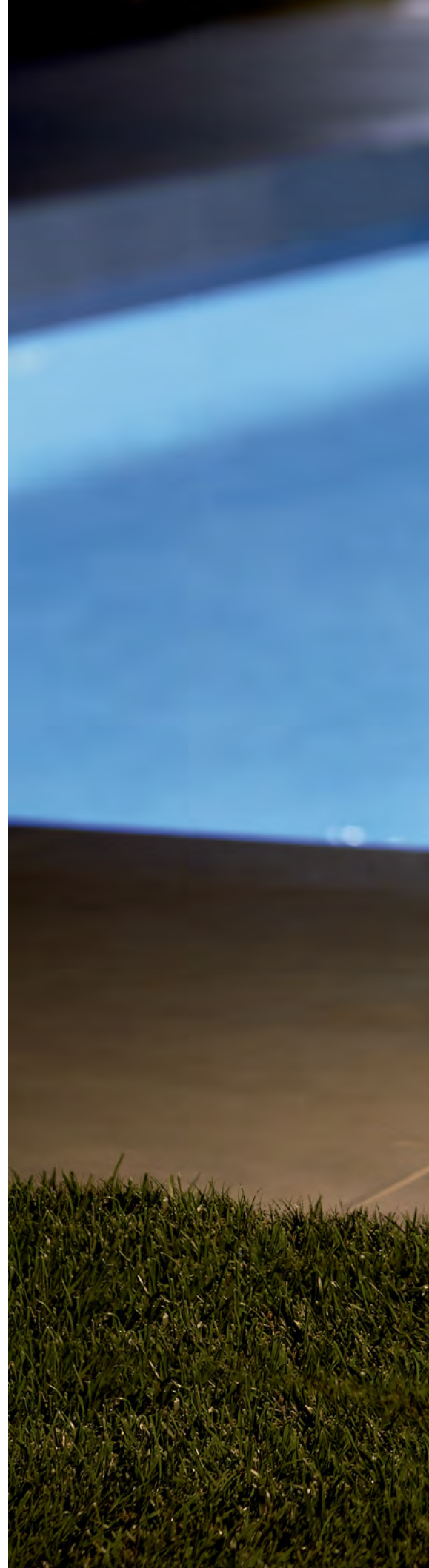



CornetB/52







Cornet B/27 IP-66

TRIAC 8 W LED / CRI: 90 / 2700°K
860 lm fuente de luz / light source

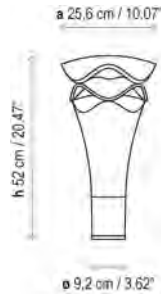

Cornet B/52 IP-66

TRIAC 8 W LED / CRI: 90 / 2700°K
860 lm fuente de luz / light source

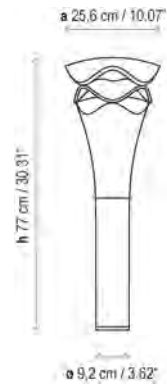

Cornet B/77 IP-66

TRIAC 8 W LED / CRI: 90 / 2700°K
860 lm fuente de luz / light source

Only for North America

Atticus B/56 - B/66 WET

TRIAC 8 W LED / CRI: 90 / 2700°K
860 lm light source

Atticus B/56 - B/66 WET

TRIAC 8 W LED / CRI: 90 / 2700°K
860 lm light source

Atticus B/56 - B/66 WET

TRIAC 8 W LED / CRI: 90 / 2700°K
860 lm light source



CornetB/52 Outdoor

Finishing / Acabados

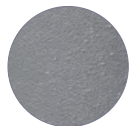

Gris Piedra
Stone Grey



“Cornet es un proyecto con alto contenido técnico. Sus líneas armónicas y orgánicas consiguen mimetizarse con la naturaleza donde no existen líneas rectas.”

“Cornet is a highly technical project. Its harmonious and organic shape allows it to blend in with nature where there are no straight lines.”



CornetB/27



Moai

by Gonzalo Milà | 2017





MoaiB/60



MoaiB/60

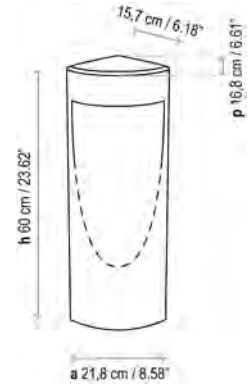

Moai B/35 IP66

  6,5 W LED / CRI: 90 / 2700°K
850 lm fuente de luz / light source

Moai B/60 IP66

  6,5 W LED / CRI: 90 / 2700°K
850 lm fuente de luz / light source

Only for North America

Moai B/35 WET

  6,5 W LED / CRI: 90 / 2700°K
850 lm light source

Moai B/60 WET

  6,5 W LED / CRI: 90 / 2700°K
850 lm light source

Moai es una lámpara de exterior donde hormigón, forma y luz trabajan juntas para dar protagonismo absoluto a esta sorprendente y novedosa unión.

Moai is an outdoor lamp where concrete, shape and light work together to highlight this surprising and innovative combination.

Finishing / Acabados

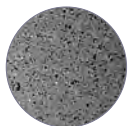

Cemento Gris
Grey Concrete



Moai B/35 | B/60

Tria

by Rubén Saldaña | 2014





Tria 04 Outdoor



Las Tria son uno de los productos con mejor aceptación de nuestro catálogo, por este motivo decidimos llevarlas hasta nuestras terrazas y jardines.

Sus formas orgánicas, como piedras de río gastadas, hacen de ellas un objeto singular. A diferencia de las Tria indoor y debido a su grado de protección IP-66, las Tria outdoor no pueden instalarse de forma modular, son luminarias individuales.

Tria is one of the most popular products of our catalogue, which is why we decided to take them outside to light our terraces and gardens.

Their organic shapes that remind us of polished river pebbles make them unique objects. Unlike the Tria Indoor and because of their IP-66 protection feature, the Tria Outdoor cannot be part of a modular system because they are single lighting units.



Tria 04 Outdoor

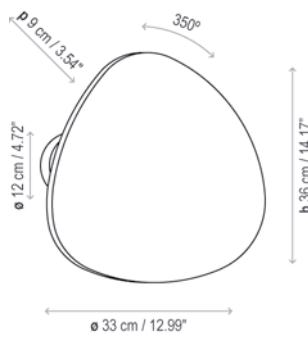
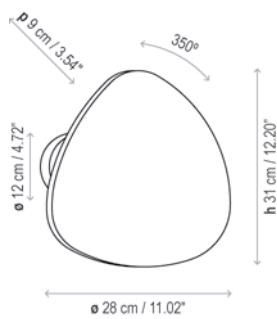
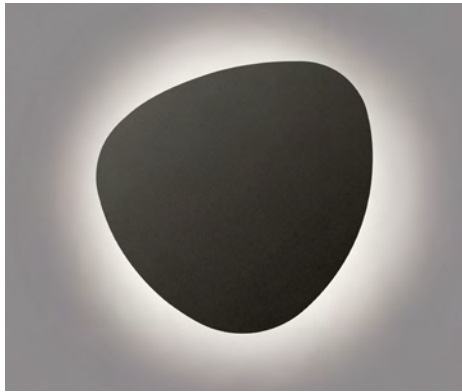

Tria 04 IP66

  11,5 W LED / CRI: 90 / 2700°K
1346 lm fuente de luz / light source

Only for North America

Tria 04 WET

  11,5 W LED / CRI: 90 / 2700°K
1346 lm light source

Tria 05 IP66

  11,5 W LED / CRI: 90 / 2700°K
1346 lm fuente de luz / light source

Tria 05 WET

  11,5 W LED / CRI: 90 / 2700°K
1346 lm light source

Acabados / Finishing



Frontal Metal Marrón Grafito
Graphite Brown Metal Frontal



Frontal Madera Teca
Teak Wood Frontal





Tria 04 Outdoor

Marietta

by Joana Bover | 2015









La Marietta es un todoterreno, resistente, fácil de limpiar y muy polivalente.

Un producto atemporal que puede convivir con productos contemporáneos, integrándose de manera natural en la vida de las personas.

Marietta goes anywhere – it is sturdy, easy to clean and very adaptable.

A timeless product that can sit happily next to contemporary products, blending naturally with people's different lifestyles.

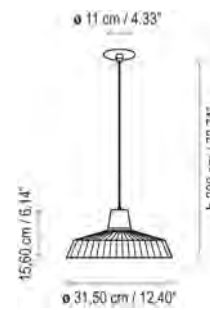

Marietta S/32 IP-66

  8 W LED / CRI: 90 / 2700°K
642 lm fuente de luz / light source

Only for North America

Marietta S/32 WET

  8 W LED / CRI: 90 / 2700°K
622 lm light source

Image does not show north American backplate

Acabados / Finishing



Blanco
White



MariettaS/32

Maxi

by Joana Bover | 2004





Maxi P/180

Opciones LED consultar dibujo
técnico en la ficha técnica

LED options consult technical
drawing in the cutsheet

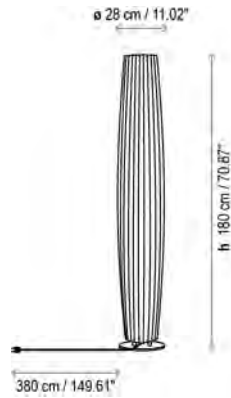

Maxi P/180 IP-66

2 x 28W T5 HE

49,2 W LED / CRI: 90 / 2700°K
7500 lm fuente de luz / light source

TRIAC 49,2 W LED / CRI: 90 / 2700°K
7500 lm fuente de luz / light source

Only for North America

Maxi P/180 WET

2 x 54W Minibipin T5 L. Fluo

49,2 W LED / CRI: 90 / 2700°K
7500 lm fuente de luz / light source

0-10V 49,2 W LED / CRI: 90 / 2700°K
7500 lm fuente de luz / light source

Opciones LED consultar dibujo
técnico en la ficha técnica

LED options consult technical
drawing in the cutsheet

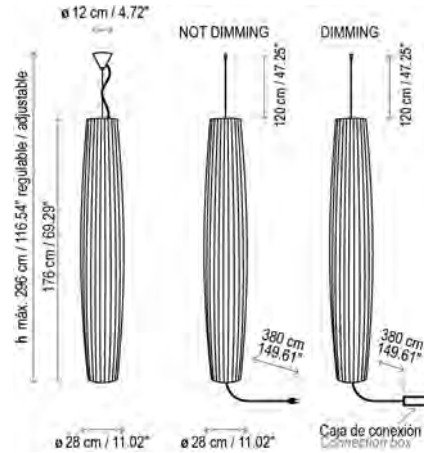

Maxi S/01 IP-66

2 x 28W T5 HE

49,2 W LED / CRI: 90 / 2700°K
7500 lm fuente de luz / light source

TRIAC 49,2 W LED / CRI: 90 / 2700°K
7500 lm fuente de luz / light source

Maxi S/01 WET

2 x 54W Minibipin T5 L. Fluo

49,2 W LED / CRI: 90 / 2700°K
7500 lm fuente de luz / light source

0-10V 49,2 W LED / CRI: 90 / 2700°K
7500 lm fuente de luz / light source

Acabados / Finishing



Blanco
White



Maxi S/01

Diseño Gráfico / Graphic Designer
Miquel Llach

Fotografías / Photographers
Jordi Solé / J.E. Estudi Disseny

Agradecimientos / Special Thanks
Mireia Sust / Hoteles Vincci
Hoteles Meliá / Mallorca
Hostal Empúries / L'Escala
Maison Diez Company / México
Moss Floristas / Madrid
Hotel Arrey / Alella
Granja El Melindro / Cardedeu

Depósito Legal / Legal Deposit: 18084-09

Novembre 2021

