



news23

 contardi

indoor

B 8 BAGGY
22 BIANCA

F 32 FLY

K 48 KIKI

S 64 STICK

outdoor

C 78 CLARA

F 88 FLY OUTDOOR

Lampade a sospensione
Suspensions

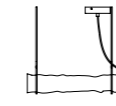

Baggy
8

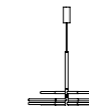

Bianca
22

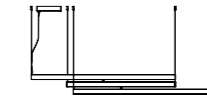

Fly
32



Kiki
48

Lampade a parete
Wall lights



Bianca
22



Fly
32



Kiki
48



Stick
64

Lampade da terra
Floor lamps



Baggy
8



Fly
32



Stick
64

Lampade da tavolo
Table lamps



Baggy
8



Kiki
48

Lampade a batteria
Battery lamps

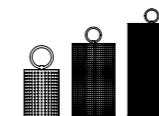

Clara
78

Lampade outdoor
Outdoor lamps

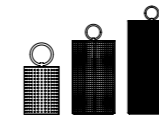

Clara
78



Fly outdoor
88

Le immagini sono inserite al solo scopo illustrativo. Le nostre finiture sono il risultato di delicati processi di lavorazione artigianale. Piccole differenze e imperfezioni non devono essere considerate difetti ma caratteristiche tipiche del prodotto, nonché garanzia di alta qualità ed unicità.

Images are for illustrative purpose only. Our finishes are the result of delicate handcraft processes. Small differences and imperfections should not be considered as defects but as specific traits of the products, as well as the guarantee of their high quality and uniqueness.

INDOOR
COLLECTION

MATERIALS AND COLOURS

INDOOR COLLECTION

Struttura / Frame

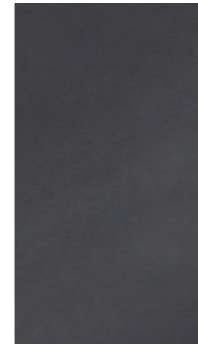

Antracite
Anthracite



Bronzo-nickel
satinato / *Brushed
bronze-nickel*

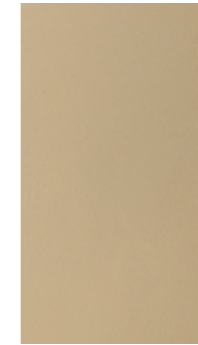

Laccato oro
Gold lacquered



Nickel dorato
satinato / *Satin
golden nickel*

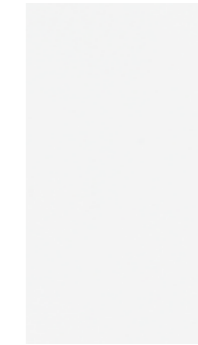

Laccato bianco
opaco / *Matt
white lacquered*



Rame satinato
Satin copper

Diffusore / Diffuser

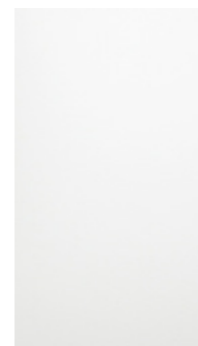

Vetro bianco opale
Opal white glass



Policarbonato
bisatinato / *Dual
satin polycarbonate*



Plexiglass rigato
Striped plexiglass

Accessori / Accessories



Corda in tessuto
color bianco/grigio
*White/grey colour
fabric rope*



Cavo in tessuto
color arancio
*Orange colour
fabric cable*



Cavo in tessuto
color sabbia
*Sand colour
fabric cable*



Cavo in tessuto
color nero
*Black colour
fabric cable*

BAGGY

PAOLA NAVONE - OTTO STUDIO





“Baggy è il risultato di un’alchimia irripetibile tra il nostro modo di progettare e Contardi. In modo molto speciale, e con sapienza, Contardi ha assecondato l’attitudine all’imperfezione del nostro approccio al design, accettando di declinare la rigorosa essenza tecnica che le appartiene in un progetto di lampade dall’equilibrio effimero e dall’aria ironica.”

*“**Baggy** is the result of an irreplicable alchemy between our way of designing and Contardi. In a very special and pertinent way, Contardi has fostered the aptitude for imperfection in our design approach, accepting an interpretation of the company’s rigorous essence, in a project of lamps of ephemeral balance and an air of irony.”*

Paola Navone - Otto Studio



Sospensione versione "Orizzontale"
"Horizontal" suspension version



Sospensioni versioni "Verticale" e "Orizzontale"
"Vertical" and "Horizontal" suspension versions



Sospensioni versioni "Verticale" e "Orizzontale"
"Vertical" and "Horizontal" suspension versions



Lampade da tavolo versioni "Trio", "Small" e "Medium"
 "Trio", "Small" and "Medium" table lamp versions



Lampada da tavolo versione "Trio"
 "Trio" table lamp version

Baggy è una collezione di lampade dal mood informale e giocoso.
 Ogni lampada Baggy è composta da moduli singoli di diverse misure che consentono
 totale libertà compositiva.

*Baggy is a collection of lamps with an informal and playful mood.
 Each Baggy lamp is composed of individual modules of different sizes that allow total
 freedom of composition.*



Lampada da terra versione "Trio"
"Trio" floor lamp version



Lampada da terra versione "Trio"
"Trio" floor lamp version

Il diffusore in policarbonato bisatinato ha l'aspetto irregolare di un tubo di carta stropicciato. La corda tessile e morbida, dettaglio in linea con il codice stilistico archi-decorativo del brand, sostiene la lampada nella versione sospesa e diventa elemento di unione per le versioni da tavolo e terra.

The dual satin polycarbonate diffuser has the irregular appearance of a crumpled paper tube. The soft textile cord, a detail in line with the brand's archi-decorative stylistic code, supports the lamp in the suspended version and becomes a joining element for the table and floor versions.



Sospensioni / Suspensions

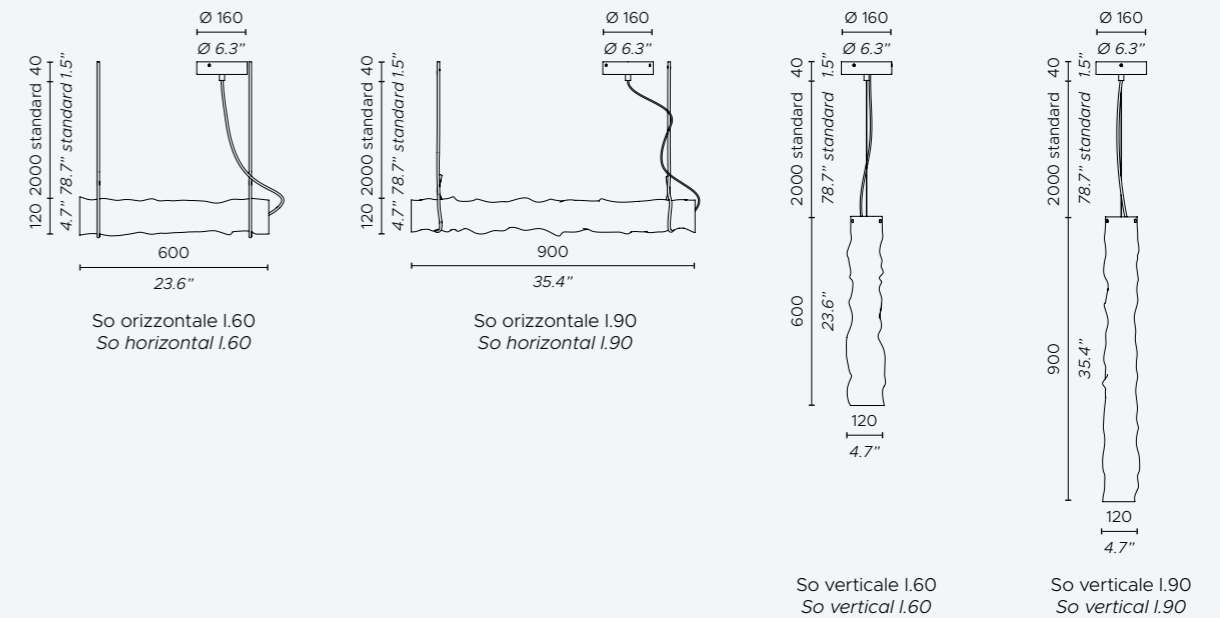

Lampada da terra / Floor lamp

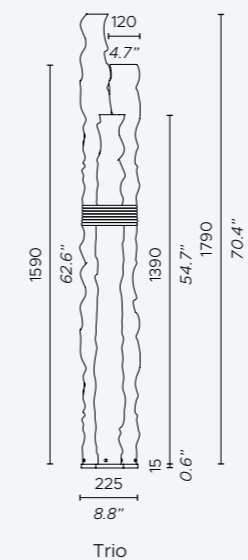

Lampade da tavolo / Table lamps

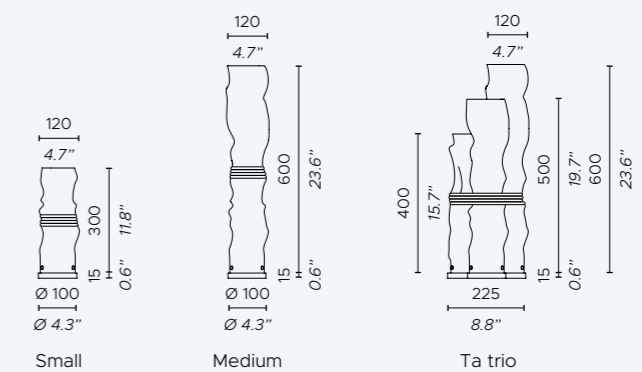

Diffusore / Diffuser

 Policarbonato bisatinato
Dual satin polycarbonate

Fonte luminosa / Light source

220 - 240V:
So - FI - Ta Custom Strip LED 15W/m

So
Dimmerazione a taglio di fase/Triac - altri sistemi di dimmerazione (DALI e 1-10V) disponibili su richiesta
Phase cut/Triac dimming - alternative dimming systems (DALI and 1-10V) available on demand

FI
Dimmerabile a piede / Dimmable with foot control

Ta
Dimmerabile con interruttore su cavo
Dimmable with switch on cable

Accessorio / Accessory

 Corda in tessuto color bianco/grigio
White/grey colour fabric rope

110V:
So - FI - Ta Custom Strip LED 15W/m

So
Dimmerazione a taglio di fase/Triac - sistema di dimmerazione 1-10V disponibile su richiesta
Phase cut/Triac dimming - 1-10V dimming system available on demand

FI
Dimmerabile a piede / Dimmable with foot control

Ta
Dimmerabile con interruttore su cavo
Dimmable with switch on cable

BIANCA

DAINELLI STUDIO





“La collaborazione con Contardi ha preso da subito un ritmo inaspettato. La nostra creatività, insieme alla loro esperienza nel trovare la migliore soluzione tecnica per ottenere l'effetto luminoso desiderato, ci ha permesso di realizzare un prodotto unico, funzionale, dall'estetica accattivante: **Bianca**. Un incontro per noi prezioso nel mondo dell'illuminazione.”

*“The collaboration with Contardi immediately took on an unexpected rhythm. Our creativity, together with their experience in finding the best technical solution to achieve a desired lighting effect, has allowed us to generate a unique, functional product with a captivating image: **Bianca**. An encounter in the world of lighting that has been very precious for us.”*





Lampada a parete
Wall light

Prodotto il cui design si ispira alla struttura del fiocco di neve.
Bianca è una lampada composta da moduli irregolari, disposti secondo una sequenza precisa si da garantirne la stabilità sia nella versione applique, sia a sospensione.

*A product whose design is inspired by the structure of the snowflake.
Bianca is a lamp composed of irregular modules, arranged in a precise sequence so as to guarantee its stability in both the wall and pendant versions.*



Lampade a parete
Wall lights



Lampade a parete / Wall lights

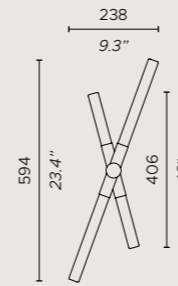

Senza base - driver remoto
Without base - remote driver
110V version: supplied with
plate to cover junction box



Con base - driver integrato
With base - driver on board
110V version: supplied with
plate to cover junction box

Sospensioni / Suspensions

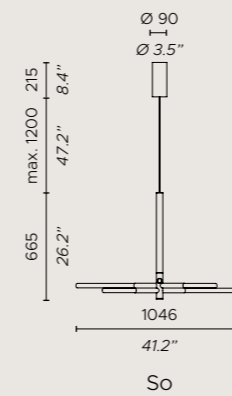

So

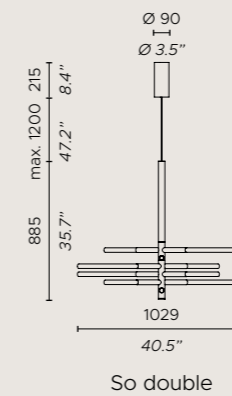

So double

Struttura / Frame

- Antracite
Anthracite
- Laccato oro
Gold lacquered

Diffusore / Diffuser

- Vetro bianco opale
Opal white glass

Fonte luminosa / Light source

220 - 240V:

Ap 2 x 5W LED + 2 x 8W LED
sorgente luminosa inclusa / light source included

So 2 x 5W LED + 2 x 8W LED + 2 x 10W LED
sorgente luminosa inclusa / light source included

So double 4 x 5W LED + 4 x 8W LED + 4 x 10W LED
sorgente luminosa inclusa / light source included

Ap - So - So double

Dimmerazione a taglio di fase/Triac - altri sistemi di dimmerazione (DALI e 1-10V) disponibili su richiesta
Phase cut/Triac dimming - alternative dimming systems (DALI and 1-10V) available on demand

110V:

Ap 2 x 5W LED + 2 x 8W LED
sorgente luminosa inclusa / light source included

So 2 x 5W LED + 2 x 8W LED + 2 x 10W LED
sorgente luminosa inclusa / light source included

So double 4 x 5W LED + 4 x 8W LED + 4 x 10W LED
sorgente luminosa inclusa / light source included

Ap - So - So double

Dimmerazione a taglio di fase/Triac - sistema di dimmerazione 1-10V disponibile su richiesta
Phase cut/Triac dimming - 1-10V dimming system available on demand



FLY

MASSIMILIANO RAGGI





“Mi lega a Contardi un rapporto professionale, di affetto e amicizia che dura da più di quindici anni.

Sono cresciuto insieme al brand, ne ho seguito lo sviluppo contribuendo ad esaltarne le caratteristiche, il codice estetico archi-decorativo e avvicinandolo progressivamente all’universo del lighting design di cui **Fly** rappresenta il mio contributo per la collezione.”

*“I am linked to Contardi by a professional relationship, of fondness and friendship, which has lasted for over 15 years. I have grown up together with the brand, watching its growth and contributing to bring out its characteristics, its archi-decorative aesthetic code, gradually bringing it into the universe of lighting design, where **Fly** represents my contribution for the Collection.”*

Massimiliano Raggi



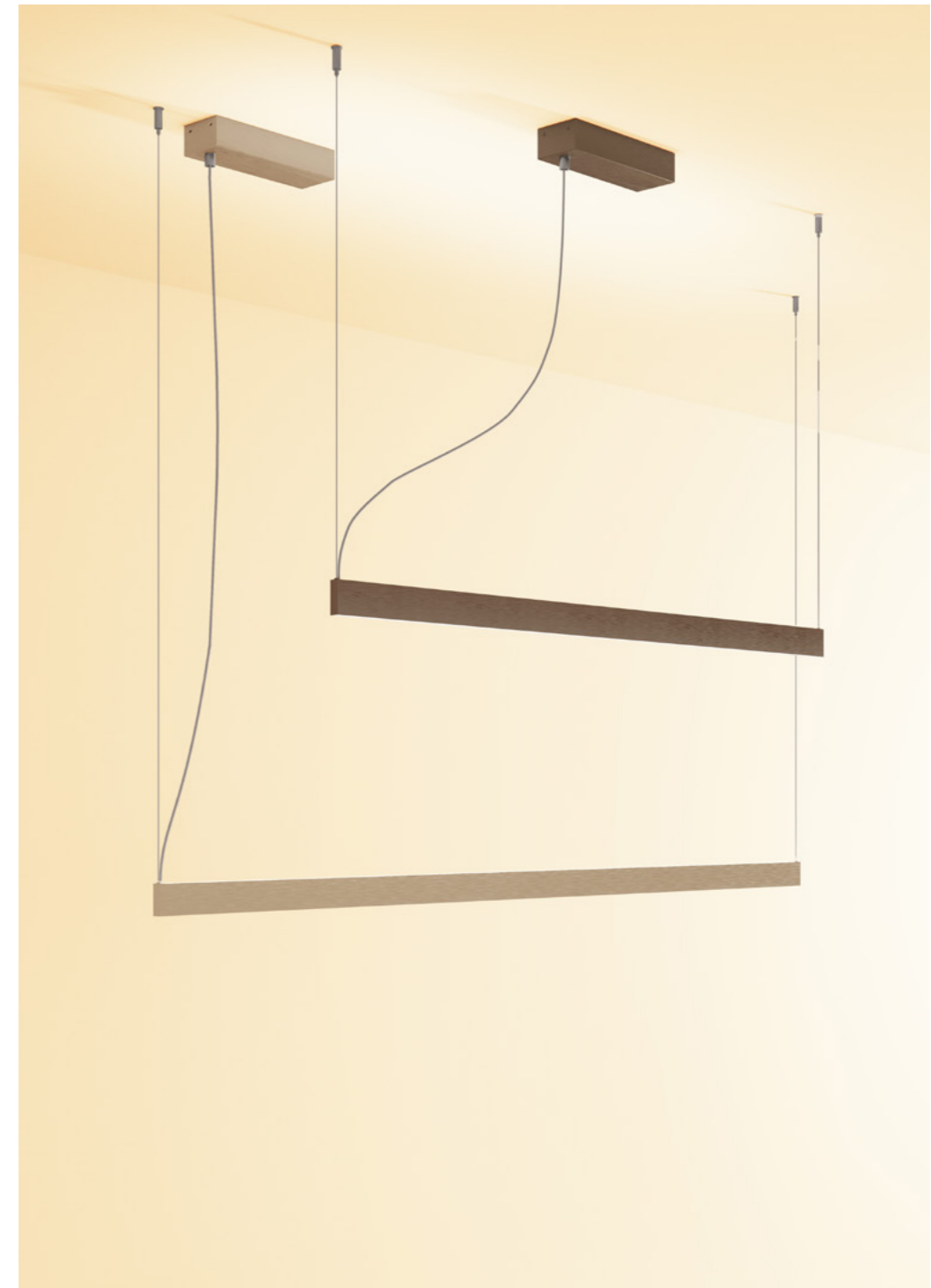
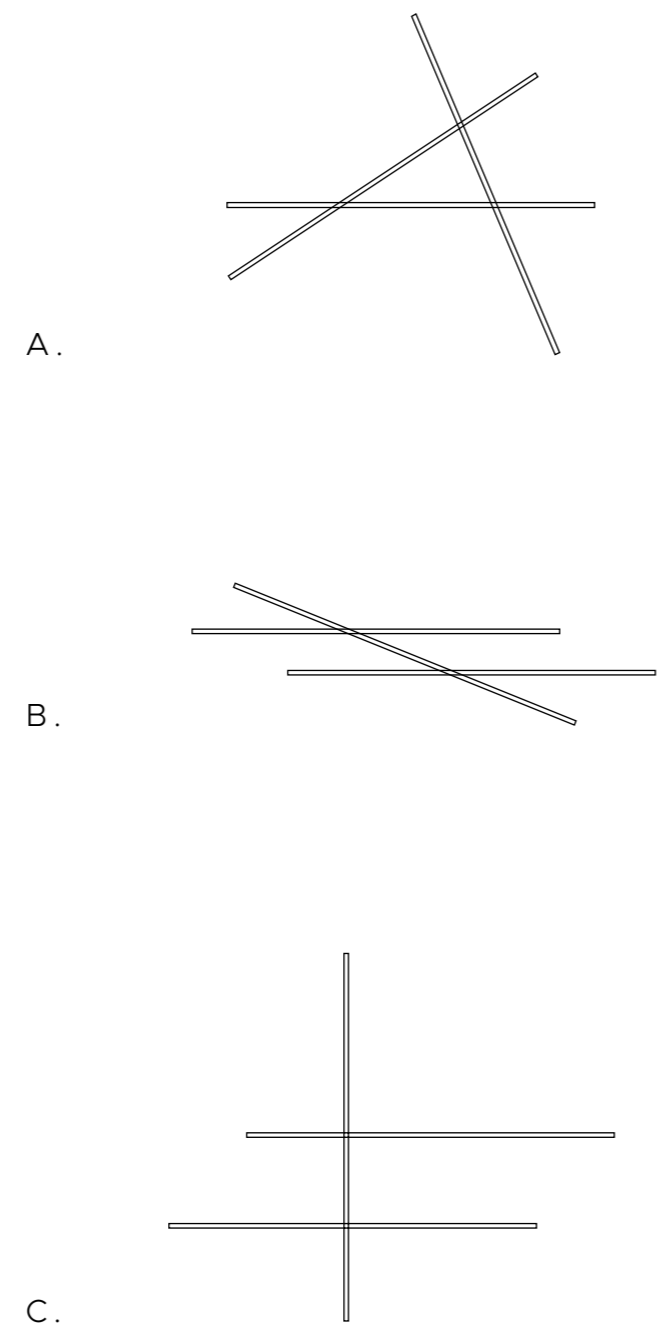
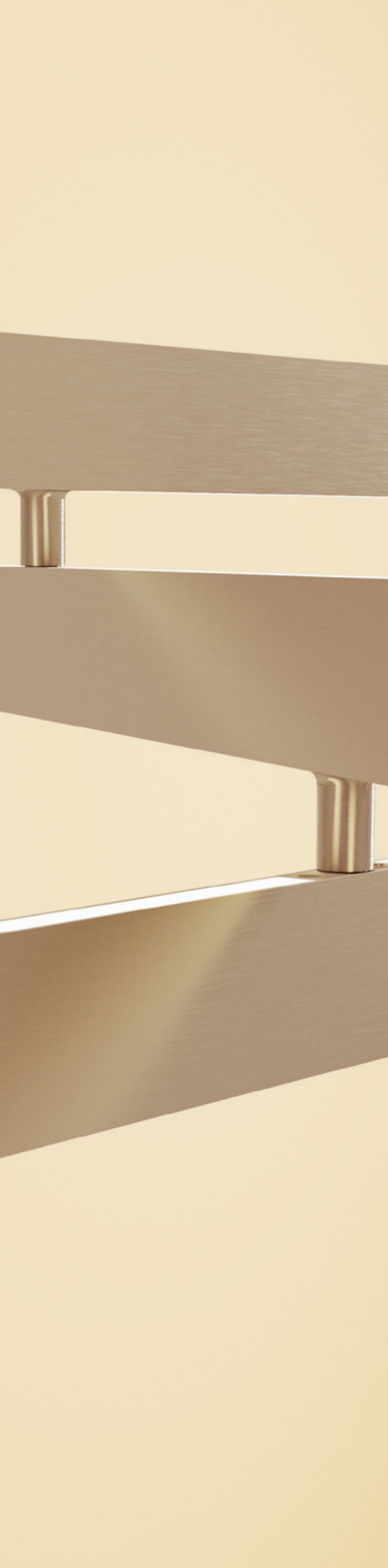

Sospensioni versioni "Linear"
"Linear" suspension versions



Lampade da terra versioni "FI" e "Long"
"FI" and "Long" floor lamp versions

Fly nasce dal desiderio progettuale di realizzare un prodotto dalla forza espressiva decisa e al tempo stesso leggera, come un tratto di matita che percorre longitudinalmente la superficie di un foglio bianco. Un segno grafico le cui proporzioni affermano l'identità di una struttura ortogonale che diventa essenziale scultura luminosa.

Fly was born from the desire to design a product with a strong expressive force and at the same time light, like a pencil that runs longitudinally along the surface of a white sheet. A graphic sign whose proportions affirm the identity of an orthogonal structure that becomes essential luminous sculpture.



Lampada da terra versione "Long"
"Long" floor lamp version



Lampada da terra versione **"Torch"** - Luce posteriore verticale e superiore indiretta
"Torch" floor lamp version - Vertical back and upper indirect light

Attraverso un processo di sottrazione il corpo luminoso, quando acceso, scompare, rivelando la sola presenza della luce. Il profilo bifacciale, nella sua semplicità, permette di orientare la luce ed enfatizzarla a seconda del taglio dalla quale emana, distribuendola nell'ambiente in modo puntuale e sofisticato.

Through a process of subtraction the luminous body, when turned on, disappears, revealing the mere presence of light. The double-sided profile, in its simplicity, allows to orient the light and emphasize it depending on the cut from which it emanates, distributing it in a timely and sophisticated way.



Lampade a parete versione **"Remote"** - driver remoto
"Remote" wall light version - remote driver

Sospensioni / Suspensions

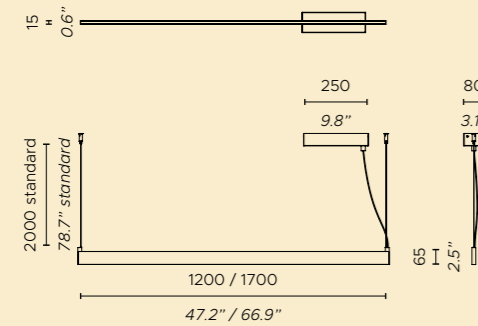

Linear I.120 / I.170

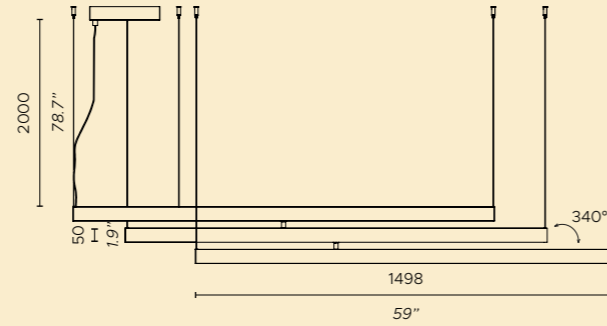

Multipla / Multiple

Lampada a parete / Wall light

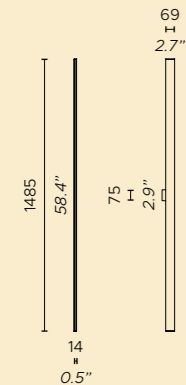

Remote

Accessorio "Remote" / "Remote" accessory

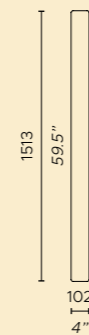

Vela

Struttura / Frame

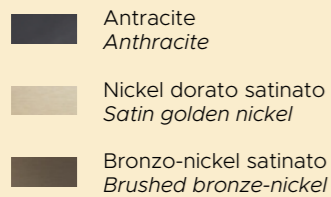

Fonte luminosa / Light source

220 - 240V:

Linear I.120 Superiore/upper 1 x 17W Strip LED;
Inferiore/down 1 x 23W Strip LED; 2700 K; CRI: >90

Linear I.170 Superiore/upper 1 x 24W Strip LED;
Inferiore/down 1 x 33W Strip LED; 2700 K; CRI: >90

Multipla Superiore/upper 1 x 42W Strip LED;
Inferiore/down 1 x 90W Strip LED; 2700 K; CRI: >90

Remote Fronte/front 1 x 21W Strip LED;
Retro/back 2 x 14W Strip LED; 2700 K; CRI: >90

Linear - Multiple - Remote

Dimmerazione a taglio di fase/Triac - altri sistemi di dimmerazione (DALI e 1-10V) disponibili su richiesta
Phase cut/Triac dimming - alternative dimming systems (DALI and 1-10V) available on demand

Accessorio vela / Vela accessory

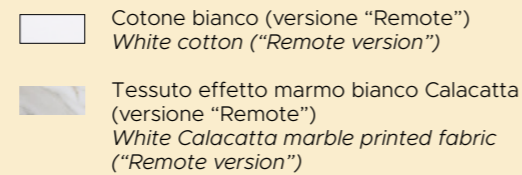
**110V:**

Linear I.120 Superiore/upper 1 x 17W Strip LED;
Inferiore/down 1 x 23W Strip LED; 2700 K; CRI: >90

Linear I.170 Superiore/upper 1 x 24W Strip LED;
Inferiore/down 1 x 33W Strip LED; 2700 K; CRI: >90

Multiple Superiore/upper 1 x 42W Strip LED;
Inferiore/down 1 x 90W Strip LED; 2700 K; CRI: >90

Remote Fronte/front 1 x 21W Strip LED;
Retro/back 2 x 14W Strip LED; 2700 K; CRI: >90

Linear - Multiple - Remote

Dimmerazione a taglio di fase/Triac - sistema di dimmerazione 1-10V disponibile su richiesta
Phase cut/Triac dimming - 1-10V dimming system available on demand

Lampade da terra / Floor lamps

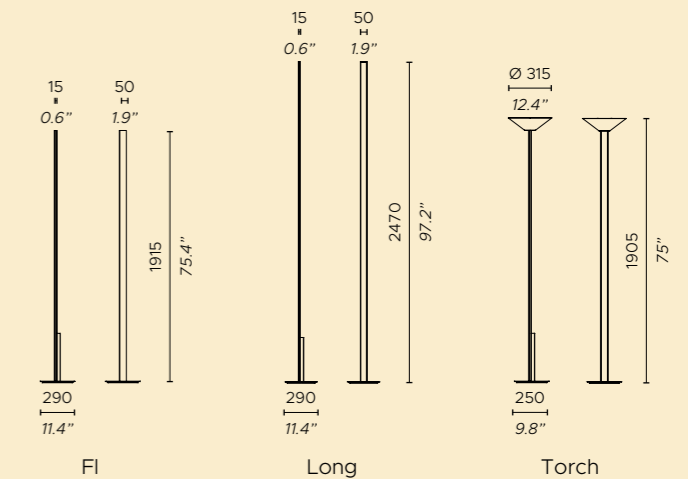
Doppio comando sensoriale lampade da terra
Double touch switch floor lamps

Struttura / Frame



Fonte luminosa / Light source

220 - 240V:

FI Fronte/front 1 x 26.5W Strip LED;
Retro/back 1 x 38W Strip LED; 2700 K; CRI: >90

Long Fronte/front 1 x 34.5W Strip LED;
Retro/back 1 x 49W Strip LED; 2700 K; CRI: >90

Torch Superiore/upper 1 x 34.5W Custom LED;
Retro/back 1 x 49W Strip LED; 2700 K; CRI: >90

FI - Long

Dimmerabile fronte e retro, doppio comando sensoriale a bordo
Dimmable front and back, double touch switch on board

Torch

Dimmerabile posteriore verticale e superiore, doppio comando sensoriale a bordo
Dimmable vertical back and upper, double touch switch on board

110V:

FI Fronte/front 1 x 26.5W Strip LED;
Retro/back 1 x 38W Strip LED; 2700 K; CRI: >90

Long Fronte/front 1 x 34.5W Strip LED;
Retro/back 1 x 49W Strip LED; 2700 K; CRI: >90

Torch Superiore/upper 1 x 34.5W Custom LED;
Retro/back 1 x 49W Strip LED; 2700 K; CRI: >90

FI - Long

Dimmerabile fronte e retro, doppio comando sensoriale a bordo
Dimmable front and back, double touch switch on board

Torch

Dimmerabile posteriore verticale e superiore, doppio comando sensoriale a bordo
Dimmable vertical back and upper, double touch switch on board

Sospensione / Suspension

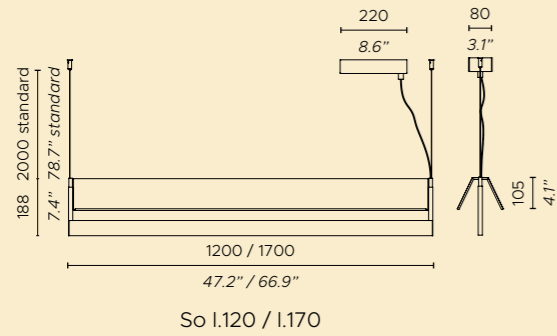

Lampada a parete / Wall light

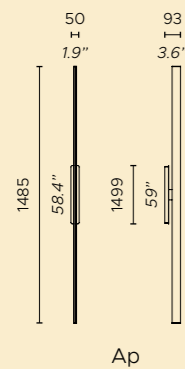

Accessorio Ap / Ap accessory

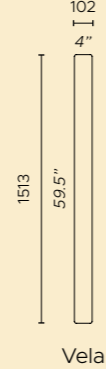

Struttura / Frame



-  Antracite
Anthracite
-  Nickel dorato satinato
Satin golden nickel
-  Bronzo-nickel satinato
Brushed bronze-nickel

Fonte luminosa / Light source

220 - 240V:
So I.120 Superiore/upper 1 x 17W Strip LED;
Inferiore/down 1 x 23W Strip LED; 2700 K; CRI: >90
So I.170 Superiore/upper 1 x 24W Strip LED;
Inferiore/down 1 x 33W Strip LED; 2700 K; CRI: >90
Ap Fronte/front 1 x 21W Strip LED;
Retro/back 2 x 14W Strip LED; 2700 K; CRI: >90

So - Ap
Dimmerazione a taglio di fase/Triac - altri sistemi di dimmerazione (DALI e 1-10V) disponibili su richiesta
Phase cut/Triac dimming - alternative dimming systems (DALI and 1-10V) available on demand

Accessorio vela / Vela accessory

-  Cotone bianco
White cotton
-  Tessuto effetto marmo bianco Calacatta
White Calacatta marble printed fabric

110V:
So I.120 Superiore/upper 1 x 17W Strip LED;
Inferiore/down 1 x 23W Strip LED; 2700 K; CRI: >90
So I.170 Superiore/upper 1 x 24W Strip LED;
Inferiore/down 1 x 33W Strip LED; 2700 K; CRI: >90
Ap Fronte/front 1 x 21W Strip LED;
Retro/back 2 x 14W Strip LED; 2700 K; CRI: >90

So - Ap
Dimmerazione a taglio di fase/Triac - sistema di dimmerazione 1-10V disponibile su richiesta
Phase cut/Triac dimming - 1-10V dimming system available on demand

Lampade a parete / Wall lights

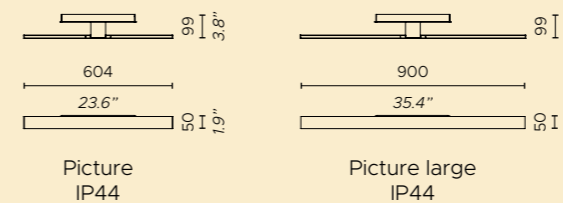

Struttura / Frame

-  Antracite
Anthracite
-  Nickel dorato satinato
Satin golden nickel
-  Bronzo-nickel satinato
Brushed bronze-nickel
-  Rame satinato
Satin copper

Fonte luminosa / Light source

220 - 240V:
Picture 1 x 11.5W Strip LED; 2700 K; CRI: >90; IP44
Picture large 1 x 17.5W Strip LED; 2700 K; CRI: >90; IP44

Picture - Picture large
Dimmerazione a taglio di fase/Triac - altri sistemi di dimmerazione (DALI e 1-10V) disponibili su richiesta
Phase cut/Triac dimming - alternative dimming systems (DALI and 1-10V) available on demand

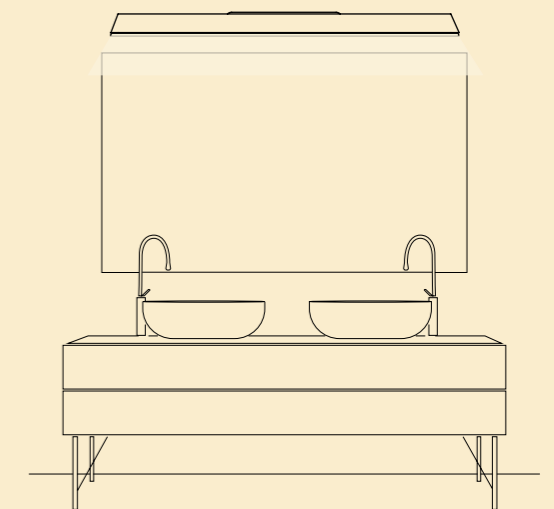

Esempio applicazione Fly picture large
Application example Fly picture large

110V:
Picture 1 x 11.5W Strip LED; 2700 K; CRI: >90; IP44
Picture large 1 x 17.5W Strip LED; 2700 K; CRI: >90; IP44

Picture - Picture large
Dimmerazione a taglio di fase/Triac - sistema di dimmerazione 1-10V disponibile su richiesta
Phase cut/Triac dimming - 1-10V dimming system available on demand



KIKI
CONTARDI STUDIO



“Con **Kiki** abbiamo espresso il desiderio di essere in collezione anche noi, a fianco dei grandi designer, con un prodotto sviluppato internamente, che rispondesse alle richieste del mercato e che esprimesse il nostro concetto di lampade. Oggetti funzionali, decorativi, strumenti di progettazione al servizio dei più creativi architetti e interior designer.”

*“With **Kiki** we have expressed the desire to be in the collection ourselves, side by side with great designers, with a product developed in-house that would respond to the requirements of the market while expressing our concept of lamps. Functional decorative objects, tools at the service of the most creative architects and interior designers.”*



Sospensioni / Suspensions

Kiki è un prodotto modulare disponibile nelle versioni sospensione, a parete e da tavolo. Il cavo in tessuto, tono su tono o in contrasto con la struttura, consente di creare sistemi e disegni su pareti. Con la versione a sospensione è possibile realizzare scenografici cluster.

Kiki is a modular product available in suspension, wall and table versions. The tone-on-tone fabric cable, or to its contrast with the structure, this product allows creative compositions on walls. With the pendant version it is possible to create scenographic clusters.



Lampada a parete
Wall light



Lampade a parete
Wall lights



Sistema modulare "Kiki connect"
"Kiki connect" modular system

ESEMPI COMPOSIZIONI **KIKI CONNECT**
KIKI CONNECT COMPOSITION EXAMPLES



A. Composizione lineare / *Linear composition*

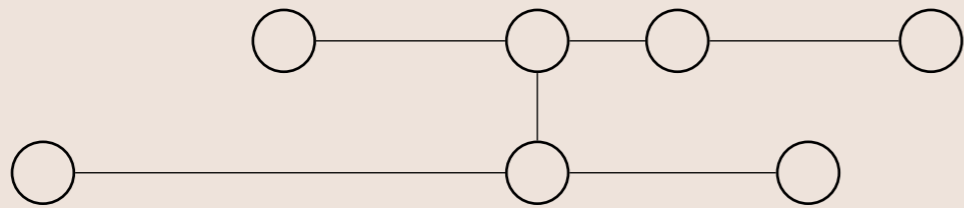

B. Composizione lineare multipla / *Multiple linear composition*

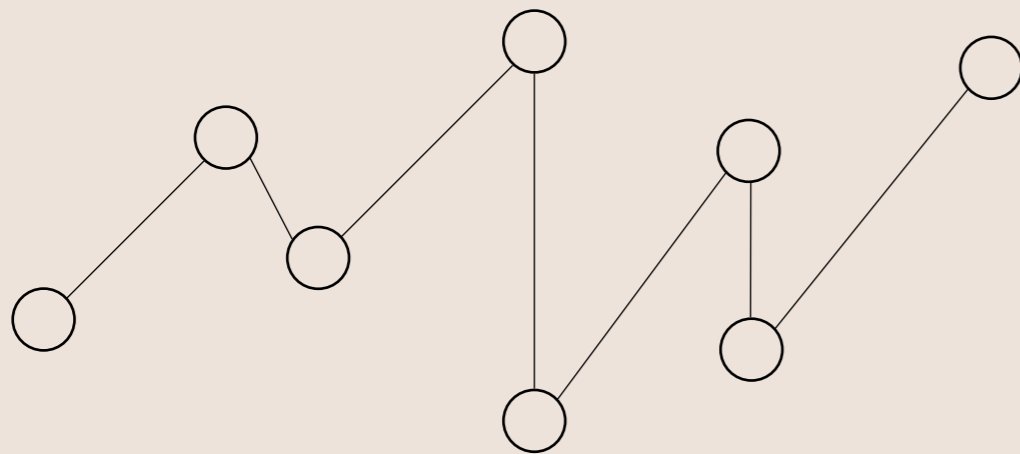

C. Composizione irregolare / *Irregular composition*

Driver a bordo compatibile con taglio di fase/Triac - Possibilità di composizioni potenzialmente infinite da una sola uscita elettrica. Uscita dei cavi ogni 45°.
 Possibilità di collegamento alla presa di corrente con spina e comando tramite interruttore.

*Driver on board compatible with phase cut/Triac - Possibility of creating infinite compositions from a single electrical output. Cable outlet at 45°.
 Possibility of connection to the socket with plug and switch control.*



Sistema modulare "**Kiki connect**"
 "**Kiki connect**" modular system



Sistema modulare "Kiki connect" con spina
"Kiki connect" modular system with plug



Lampada da tavolo
Table lamp

Lampade a parete / Wall lights

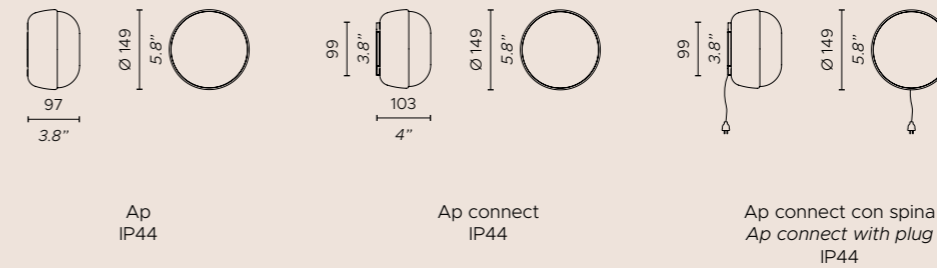

Lampada da tavolo Table lamp

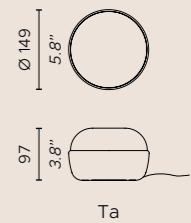

Sospensioni / Suspensions

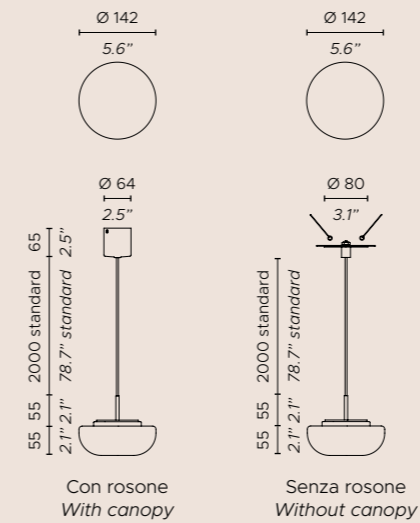

Cluster rotondi / Round clusters

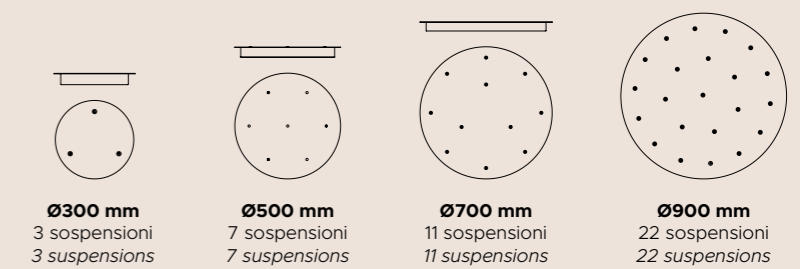

Cluster lineari / Linear clusters

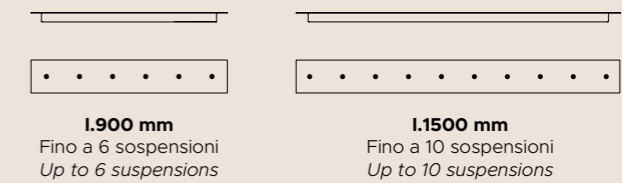

Accessorio So - Ap connect / So - Ap connect accessory

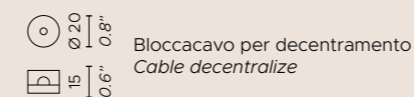

Struttura / Frame

- Antracite / Anthracite
- Nickel dorato satinato / Satin golden nickel
- Bronzo-nickel satinato / Brushed bronze-nickel
- Laccato bianco opaco (Ap - Ap connect) / Matt white lacquered (Ap - Ap connect)

Fonte luminosa / Light source

220 - 240V:
Ap - So - Ta 1 x 5W Custom LED; 550 Lm; 2700 K; CRI: >90

Ap - So
Dimmerazione a taglio di fase/Triac - altri sistemi di dimmerazione (DALI e 1-10V) disponibili su richiesta / Phase cut/Triac dimming - alternative dimming systems (DALI and 1-10V) available on demand
Ta
Dimmerabile, interruttore push sulla base / Dimmable, push switch on the base

Diffusore / Diffuser

- Vetro bianco opale / Satin opal glass

Accessori Ap connect / Ap connect accessories

- Cavo in tessuto color arancio / Orange colour fabric cable
- Cavo in tessuto color sabbia / Sand colour fabric cable
- Cavo in tessuto color nero / Black colour fabric cable

110V:
Ap - So - Ta 1 x 5W Custom LED; 550 Lm; 2700 K; CRI: >90

Ap - So
Dimmerazione a taglio di fase/Triac - sistema di dimmerazione 1-10V disponibile su richiesta / Phase cut/Triac dimming - 1-10V dimming system available on demand
Ta
Dimmerabile, interruttore push sulla base / Dimmable, push switch on the base



STICK

STUDIOPEPE





“La purezza che volevamo ottenere con **Stick** è stata raggiunta grazie alla collaborazione con i tecnici della luce di Contardi. Progettare e disegnare ogni minimo dettaglio costruttivo insieme al loro team ha permesso di ottenere un prisma di pulizia estrema, esteriormente semplice ed essenziale, contenitore di una tecnologia articolata.”

*“The purity we wanted to achieve with **Stick** has been reached thanks to collaboration with the light technicians of Contardi. To design every constructive detail, down to the smallest, together with their theme has permitted us to obtain a prism of extreme refinement, simple and essential on the outside, but containing complex technology.”*



Lampade da terra
Floor lamps

In Stick la luce si propaga, sapientemente modulata, attraverso un diffusore con effetto vetro cannettato, contenuto all'interno di un estruso metallico nelle finiture satinato rame e nickel dorato.

In Stick the light emanates, skillfully modulated, through a diffuser with a ribbed glass effect, contained within a metal extrusion in satin copper and gold nickel finishes.



Lampada da terra
Floor lamp



Lampade a parete
Wall lights

Lampada da terra / Floor lamp

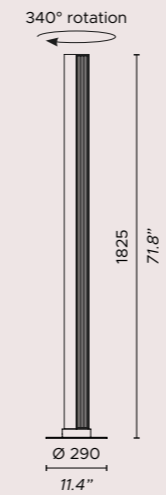

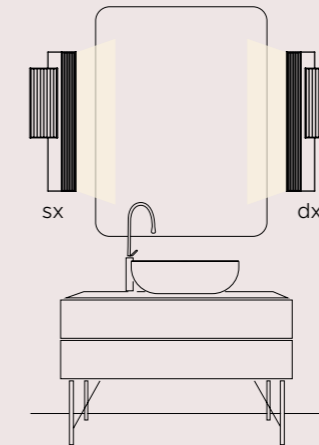
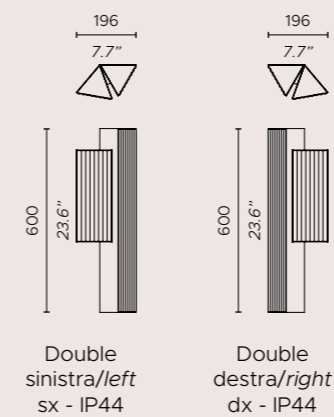

Lampade a parete / Wall lights



Esempio applicazione
ap double destra e sinistra
Application example
ap double right and left

Struttura / Frame

-  Nickel dorato satinato
Satin golden nickel
-  Rame satinato
Satin copper

Diffusore / Diffuser

-  Plexiglass rigato
Striped plexiglass

Fonte luminosa - Light source

220 - 240V:
Ap double sinistra e destra / left and right
 1 x 13.5W Custom LED + 1 x 27W Custom LED;
 3750 Lm; 2700 K; CRI: >90; IP44
FI 5 x 13.5W Custom LED; 7500 Lm; 2700 K; CRI: >90

Ap double sinistra e destra / left and right
 Dimmerazione a taglio di fase/Triac - altri sistemi
 di dimmerazione (DALI e 1-10V) disponibili su richiesta
*Phase cut/Triac dimming - alternative dimming
 systems (DALI and 1-10V) available on demand*
FI
 Dimmerabile a piede / Foot dimmable

110V:
Ap double sinistra e destra / left and right
 1 x 13.5W Custom LED + 1 x 27W Custom LED;
 3750 Lm; 2700 K; CRI: >90; IP44
FI 5 x 13.5W Custom LED; 7500 Lm; 2700 K; CRI: >90

Ap double sinistra e destra / left and right
 Dimmerazione a taglio di fase/Triac - sistema
 di dimmerazione 1-10V disponibile su richiesta
*Phase cut/Triac dimming - 1-10V dimming
 system available on demand*
FI
 Dimmerabile a piede / Foot dimmable

Sospensioni / Suspensions

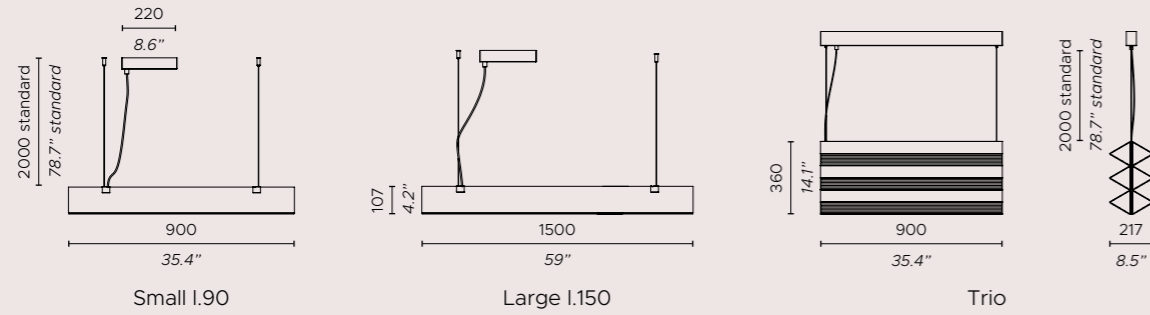

Lampade a parete / Wall lights

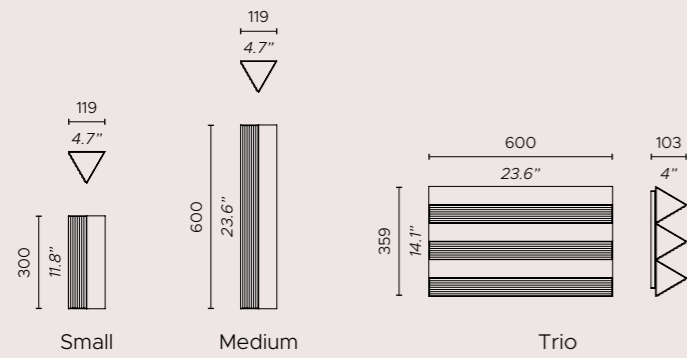

Fonte luminosa - Light source

220 - 240V:

So small I.90 1 x 40W Custom LED; 3750 Lm; 2700 K; CRI: >90

So large I.150 1 x 65W Custom LED; 6250 Lm; 2700 K; CRI: >90

So trio 6 x 40W Custom LED; 22500 Lm; 2700 K; CRI: >90

Ap small 1 x 13.5W Custom LED; 1250 Lm; 2700 K; CRI: >90

Ap medium 1 x 27W Custom LED; 2500 Lm; 2700 K; CRI: >90

Ap trio 3 x 27W Custom LED; 7500 Lm; 2700 K; CRI: >90

110V:

So small I.90 1 x 40W Custom LED; 3750 Lm; 2700 K; CRI: >90

So large I.150 1 x 65W Custom LED; 6250 Lm; 2700 K; CRI: >90

So trio 6 x 40W Custom LED; 22500 Lm; 2700 K; CRI: >90

Ap small 1 x 13.5W Custom LED; 1250 Lm; 2700 K; CRI: >90

Ap medium 1 x 27W Custom LED; 2500 Lm; 2700 K; CRI: >90

Ap trio 3 x 27W Custom LED; 7500 Lm; 2700 K; CRI: >90

Dimmerazione a taglio di fase/Triac - altri sistemi di dimmerazione (DALI e 1-10V) disponibili su richiesta
Phase cut/Triac dimming - alternative dimming systems (DALI and 1-10V) available on demand

Dimmerazione a taglio di fase/Triac - sistema di dimmerazione 1-10V disponibile su richiesta
Phase cut/Triac dimming - 1-10V dimming system available on demand





OUTDOOR
COLLECTION
IP65



MATERIALS AND COLOURS

OUTDOOR COLLECTION

Struttura / Frame



Laccato bronzo
Bronze lacquered



Laccato nero
Black lacquered

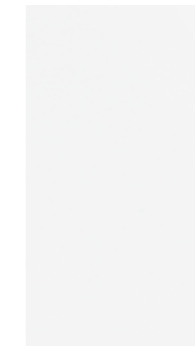

Laccato bianco
opaco / *Matt
white lacquered*

Diffusore / Diffuser



Resina effetto
paglia di Vienna
*Vienna straw
resin effect*

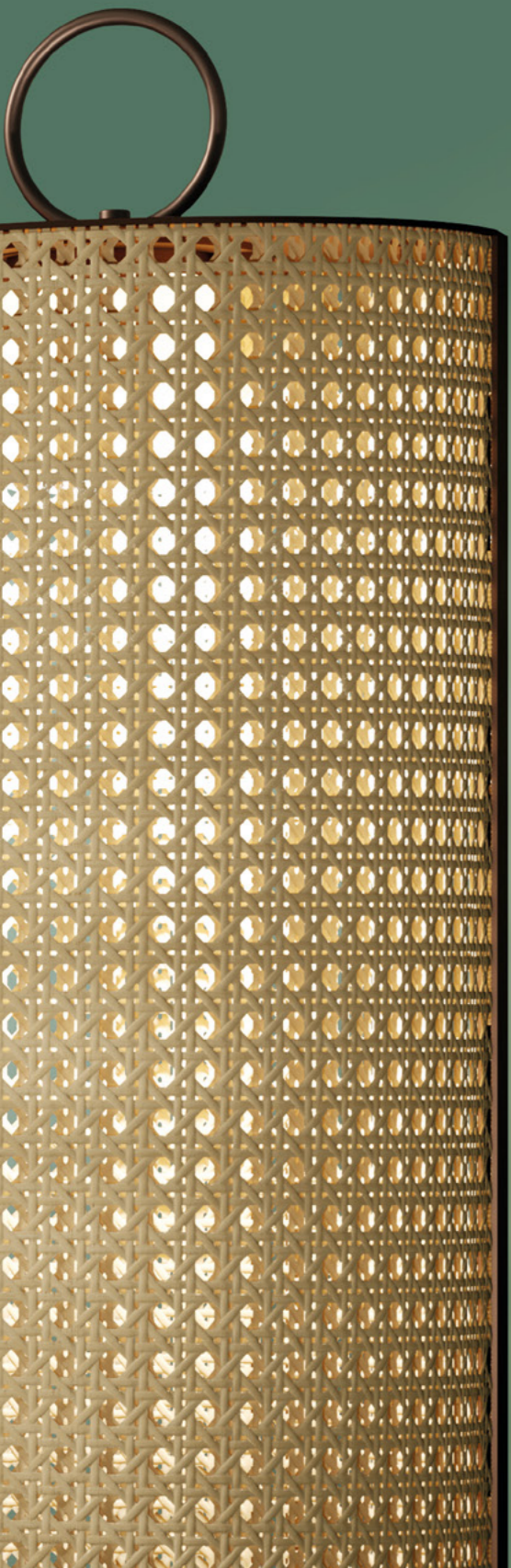

CLARA

CHIARA CABERLON

in collaborazione con Marco Forbicioni
in collaboration with Marco Forbicioni

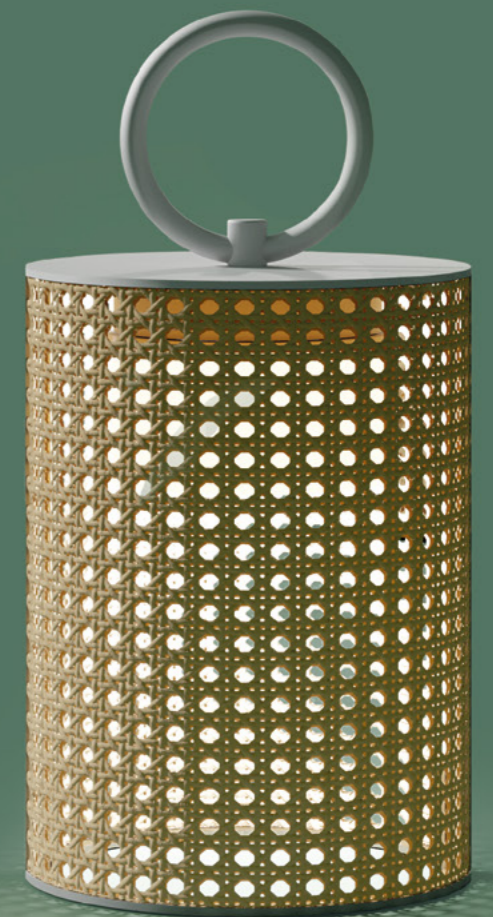



“La collezione di lampade **Clara** è nata per rispondere a una richiesta di Contardi di dare vita a una collezione outdoor IP65 destinata al mercato contract. Ne è uscita una lanterna trasportabile dall’anima nomade, che grazie all’incredibile expertise dell’azienda nella scelta e lavorazione dei materiali, sprigiona una magica luce calda e suggestiva.”

*“The **Clara** collection of lamps has been created to respond to a request on the part of Contardi to formulate an outdoor collection IP65 for the contract market. The result is a portable lantern with a nomadic spirit, which thanks to the company’s incredible expertise and approach to materials broadcasts magical, warm and evocative light.”*

Chiara Caberlon

in collaborazione con
in collaboration with
Marco Forbicioni



Versione "small" a batteria
"Small" battery-powered version

Clara nasce dal concetto di "portare luce". Un elemento luminoso facilmente trasportabile ovunque, grazie alla scelta dell'alimentazione a batteria ricaricabile e alla presenza di un anello allocato nella parte superiore che funge da gancio per appenderla o spostarla.

Clara comes from the concept of "bringing light". A light element easily transportable anywhere, thanks to the choice of the rechargeable battery power supply and the presence of a ring allocated at the top that serves as a hook to hang or move it.



Lampade a batteria
Battery-powered lamps



Lampade a batteria
Battery-powered lamps



Fonte luminosa estraibile, trasportabile, a batteria ricaricabile
Removable, transportable, rechargeable light source

Lampade a batteria / Battery-powered lamps

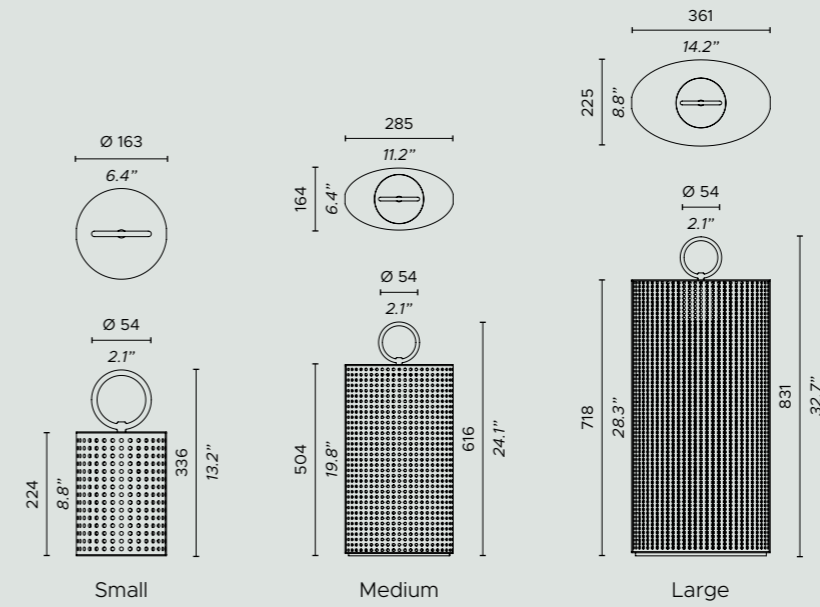

TRASPORTABILITÀ TRANSPORTABILITY



ACCENSIONE / SPEGNIMENTO ON / OFF SWITCHING

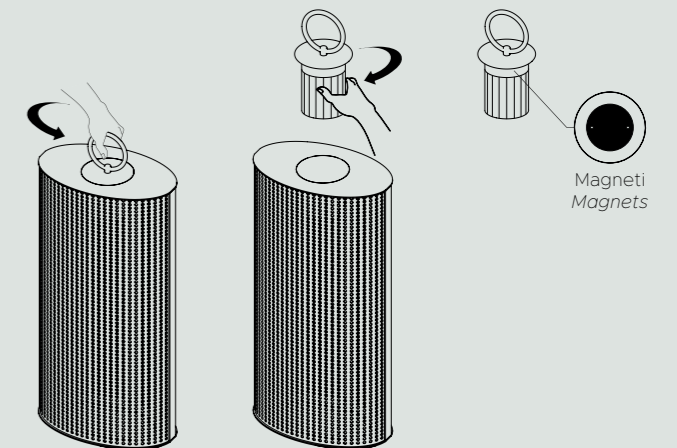

Struttura / Frame

 Laccato bianco opaco
Matt white lacquered

 Laccato bronzo
Bronze lacquered

Diffusore / Diffuser

 Resina effetto paglia di Vienna
Vienna straw resin effect

Fonte luminosa - Light source

Battery 1 x 4W LED module; 400 Lm;
2700 K; CRI: >90

IP65

FLY
OUTDOOR
MASSIMILIANO RAGGI

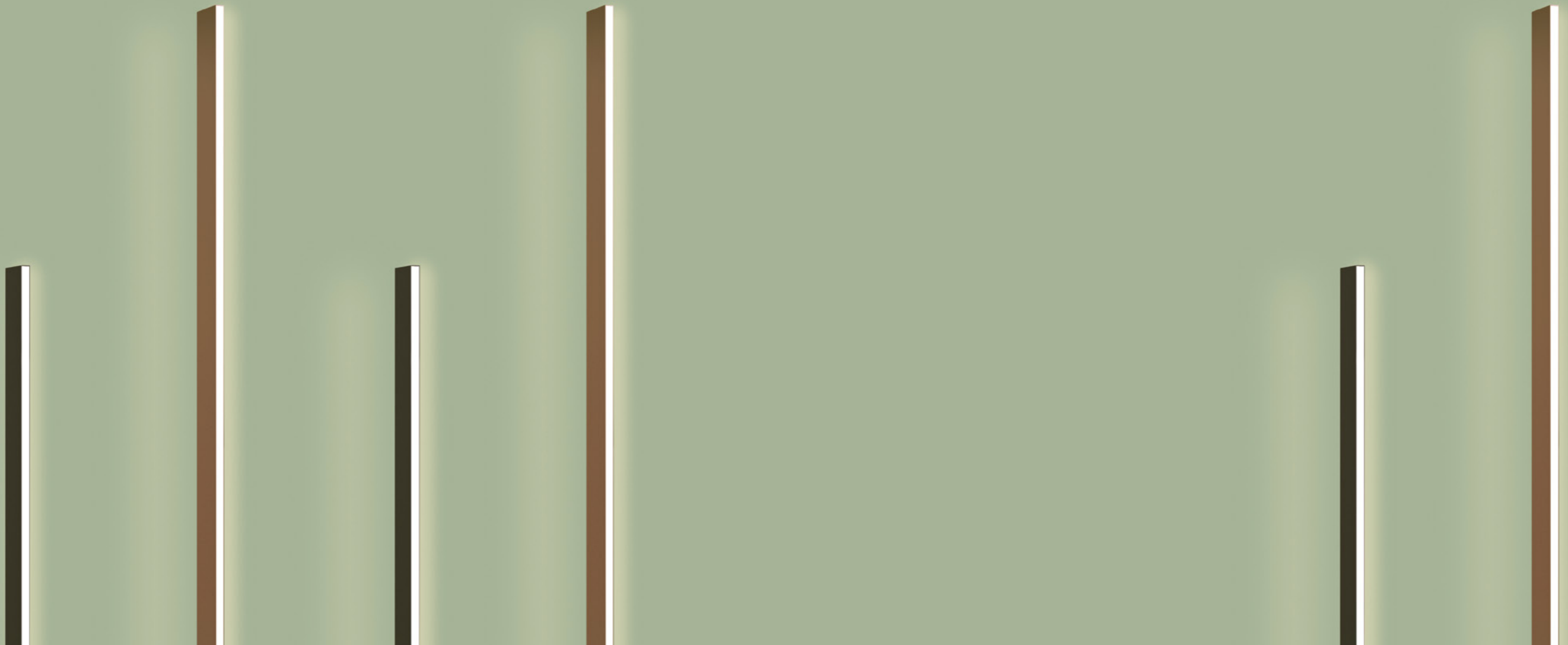



Lampade outdoor da terra
Outdoor floor lamps



Lampade outdoor da terra
Outdoor floor lamps

Lampade da terra / Floor lamps

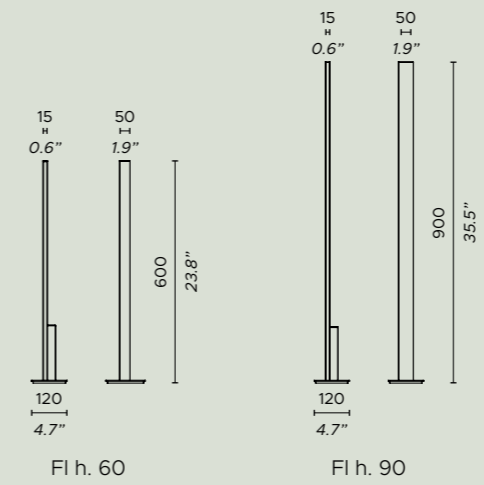

Struttura / Frame

- Laccato nero
Black lacquered
- Laccato bronzo
Bronze lacquered

Fonte luminosa - Light source

- Fl h.60 1 x 8W Custom LED; 2700 K
- Fl h.90 1 x 12.5W Custom LED; 2700 K

IP65

THANKS TO

Graphic Project:

Claudia Parisi

Mise en page:

Martina Castiglieri

Photos:

Marco Reggi

Render:

Arché Agency
Officine Mimesi
Dainelli Studio

Print:

Grafiche Antiga, Crocetta del Montello (TV)

@Contardi Lighting srl
07.2023

**CONTARDI LIGHTING SRL**

Italy Headquarters
Via A. Manzoni, 134/140
20811 Cesano Maderno (MB)

CONTARDI MILANO

Showroom
Corso Monforte, 20
20122 Milano (MI)

CONTARDI USA Inc

USA Branch
151 Wooster St - Floor 2
10012 New York - NY

CONTARDI LIGHTING Srl
Italy Headquarters

Via A. Manzoni, 134/140
20811 Cesano Maderno (MB)
Phone: +39 0362 301381
Mail: sales@contardi-italia.it
contardi-italia.com

CONTARDI MILANO
Showroom

Corso Monforte, 20
20122 Milano (MI)
Phone: +39 02 82 76 5952
Mail: milano@contardi-italia.it
contardi-italia.it/showroom

CONTARDI USA Inc
USA Branch

151 Wooster St - Floor 2
10012 New York - NY
Phone: +1 718 715 0717
Mail: office@contardi-usa.com
contardi-usa.com

@Contardi Lighting srl
07.2023

Follow **Contardi Lighting** on:

