

# DelightFULL<sup>®</sup>

Unique Lamps

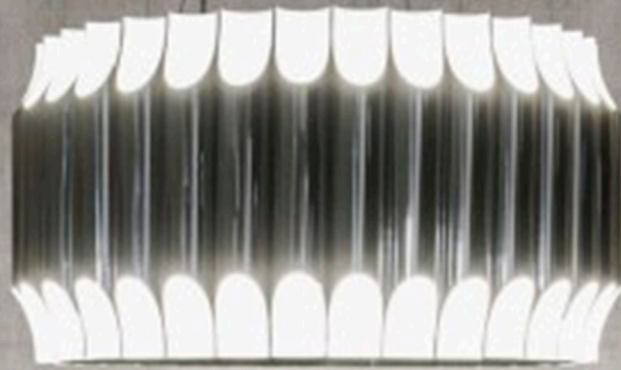



Dedicated to

Everyone that fights to be  
unique and inspire others

DelightFULL creates mid-century modern retro lighting.  
A unique design for a modern or contemporary interior.  
100% handmade suspension, floor, table and wall fixtures.

## DELIGHTFULL'S FRIENDS

---

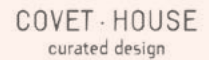



# Delightfull's Lighting Embodies A Sincere Passion For Innovation And A True Dedication To The Revival Of Local Artisan Craftsmanship Through Long Lasting Masterpieces.

HERITAGE  
COLLECTION

*Graphic*  
lamp collection

---

*"The 50's retro style refashioned by DELIGHTFULL's modern design twist".*

---

## WHY SHOULD YOU LOVE DELIGHTFULL?

In short, we are what we do. Vintage music & mid-century modern design lovers with a peculiar affection to 50's recreations with our modern senses. It's all about restoring the post-war era with our eyes and hands set in the future.

We can gaze at the Etta Wall Sconce, or the Amy Floor Lamp, or the Billy Table Lamp, and instinctively respond, with a smile, "Yeah, I get that." This is how 50's would look like in the future! – That's Delightfull.

Art deco iconography inspired the line of contemporary lighting tailored for the floor, table, ceiling and wall.

## WE STRIVE FOR THE FOLLOWING VALUES:

**DESIGN** - Each unique Stilnovo lamp is a hymn to vintage lighting classics with a retro vibe smoothly reinterpreted by iconic contemporary designs.

**CRAFTMANSHIP - DELIGHTFULL** is recovering the best handmade techniques, employing materials and color schematics that are aesthetically appropriate to the '40's, '50's and '60's.

**MUSIC** - Post-war design and music sharply inform styling choices, from the referencing of mid-century modernist iconography to the playful cool jazz-inspired names (Brubeck, Miles, Coltrane) of the fixtures.

**UNIQUENESS** - Delightfull takes a passion for the vintage hip trend and has creatively crafted a unique and contemporary lighting line for nowadays.

**DESIGN** | Passion for classics, sculptured forms, reduced shapes, clear lines and strong colors: this is the way DelightFULL Studio leaves its mark in the design world. DelightFULL's lighting designs have the most incredible mid-century free spirit, filled with a touch of luxury and modernity.

**FRESH CLASSICS** | Meet the 40's, 50's, 60's and 70's with DelightFULL's designs. Let this mid-century twist enter your bones and let yourself go with the brand's dynamism, achieved through a young creative team that has the ability to anticipate and set the best trends.

**COLLECTIONS** | Heritage and Graphic Collection are the two collections that will conquer you. DelightFULL's very complete product's families will also surprise you with its unique fresh classics.

**HANDCRAFT** | Old Techniques, attention to detail and a modernized human touch result in a uniqueness that you'll want to meet in a very deep and intense way. All our pieces are handmade in Portugal by the best craftsmen and have a production time of 6-8 weeks.

**CUSTOM** | Accomplish your custom project with success using the perfect lamp. It will be hard to choose just one of all the different possibilities of finishes that DelightFULL offers. We can adapt any piece to your projects, whether in dimensions, color or finishes.

**RECOGNIZEMENT** | These luxury mid-century modern designs are featured in some of the best interior design projects in the world. The Ritz-Carlton Wolfsburg and Paramount Hotel in New York are just two of the examples of the brand's recognition.

**NOVELTIES** | New products every month: this is one of DelightFULL's promises and it will always be respected. The brand's dynamism corresponds with the launch of at least one piece per month.

**LEAD TIME** | This brand's Heritage Collection will be ready to ship between 4 and 6 weeks. Graphic Collection needs between 6 and 8 weeks to achieve its uniqueness.





**LOCAL PRESENCE** | You will be able to find DelightFULL's lamps at the best design events worldwide. The brand has a strong presence in the best showrooms overseas and the most incredible and serious partnerships are made every week. The participation in international design fairs such as Maison et Objet, Milan Design Week, IMM Cologne, ICFE and 100% Design places DelightFULL on the front-page of world's design.

**READY TO SHIP** | Constant growing stock completes our ready to ship list. Check the products that DelightFULL has available to send right away and complete your project.

**COMMUNICATION** | Our materials, shapes and lines are the best way to communicate. Find inspiring pictures of DelightFULL's pieces and projects in the brand's press area. Experience the brand over promotional actions and creative videos.

**PARTNERSHIP** | Top brands and stores are more than our partners: they are our friends. Visit Harrod's store in London or Printemps in Paris to find DelightFULL's unique pieces.

**PRESS COVERAGE** | Growing notoriety worldwide is one of the brand's characteristics. The brand's PR team will ensure the presence of your projects in the strongest worldwide recognized interior design, decor and lifestyle Magazines in the world.

**PRICE** | We have adjusted our prices to the market, to guarantee good service at the highest quality. We believe that the price reflects what the Brand is today, keeping our client's wishes in mind.

**QUALITY** | Today we have a solid structure and factory to provide you the best quality you can get. We offer you the best materials and finishes.

**YOU** | This year DelightFULL made a commitment with you! During this year, new design and new pieces were not our main focus, and the reason is that we were concerned with improving our customer service. With a new lead time and new machinery, we want to guarantee you the best quality and lead time. We want YOU to be happy.

SUSPENSION

FLOOR

TABLE

WALL

GRAPHIC



AMY pp. 12



ARETHA pp. 14



ATOMIC pp. 16



ATOMIC CEILING pp. 18



ATOMIC ROUND pp. 20



BASIE pp. 22



BOTTI pp. 24



BOTTI PENDANT pp. 26



BRUBECK pp. 28



BRUBECK PENDANT pp. 30



BRUBECK CHANDELIER pp. 32



CANNONBALL pp. 34



CHARLES pp. 36



CLARK pp. 38



COLTRANE pp. 40



CONNOR pp. 42



COSMO pp. 44



DIANA pp. 46



DORSEY pp. 48



DUKE pp. 50



ELLA pp. 52



ETTA ROUND pp. 54



ETTA CHANDELIER pp. 56



ETTA PENDANT pp. 58



GALLIANO ROUND pp. 60



GALLIANO PENDANT pp. 62



HANK pp. 64



HANNA CHANDELIER pp. 66



HANNA pp. 68



HENDRIX pp. 70



HENDRIX CHANDELIER pp. 72



IKE pp. 74



IKE PENDANT pp. 76



JACKSON pp. 78



KRAVITZ pp. 80



LAINE pp. 82



MADELEINE pp. 84



MATHENY ROUND pp. 86



MATHENY PENDANT pp. 88



NEIL pp. 90



NORAH pp. 92



PEGGY pp. 94



SIMONE pp. 96



SINATRA pp. 98



STANLEY pp. 100



TURNER pp. 102

SUSPENSION

FLOOR

TABLE

WALL

GRAPHIC



AMY pp. 104



ARMSTRONG pp. 106



BOTTI pp. 108



BRUBECK pp. 110



COLE pp. 112



COLEMAN pp. 114



COLTRANE pp. 116



DIANA pp. 118



DUKE pp. 120



EVANS pp. 122



HANNA pp. 124



HERBIE pp. 126



IKE 3 pp. 128



JACKSON pp. 130



JANIS pp. 132



LEE pp. 134



MATHENY pp. 136



MILES pp. 138



NEIL pp. 140



PASTORIUS pp. 142



SCOFIELD pp. 144



SIMONE pp. 146



SINATRA pp. 148



STANLEY pp. 150



STARDUST pp. 152



TORCHIERE pp. 154



TURNER pp. 156



SUSPENSION

FLOOR

TABLE

WALL

GRAPHIC

DE



AMY pp. 160



ATOMIC pp. 162



BARRY pp. 164



BASIE pp. 166



BILLY pp. 168



BOTTI pp. 170



COLTRANE pp. 172



DIANA pp. 174



DONNA pp. 176



JANIS pp. 178



KENNY pp. 180



MARCUS pp. x



MATHENY pp. 182



MEOLA pp. 184



MILES pp. 186



TURNER pp. 188

SUSPENSION

FLOOR

TABLE

WALL

GRAPHIC



ATOMIC pp. 194



BASIE pp. 196



BRUBECK pp. 198



CHARLES pp. 200



CHUCK pp. 202



COLTRANE pp. 204



DIANA pp. 206



DIZZY pp. 208



ELLA pp. 210



ETTA pp. 212



EVANS pp. 214



GALLIANO pp. 216



HANNA pp. 218



HENDRIX pp. 220



MATHENY pp. 222



MILES pp. 224



NORAH pp. 226



PARKER pp. 228



PASTORIUS pp. 230



PIAZZOLA pp. 232



SIMONE pp. 234



TURNER pp. 236



# SUSPENSION



# AMY

## SUSPENSION LAMP

Amy modern chandelier is a new take on the classic mid-century modern chandeliers of the 50s and 60s. Inspired by the great singer and songwriter, this unique chandelier tries to embody the soul of the British legend. With a body handmade in brass and five aluminum shades, this mid-century modern chandelier looks exactly like it was made in the 50s. The shades are adjustable so that you can create the right lighting effect for your room. All in all, it is a classy black chandelier, and a great modern dining room lighting solution.

### MATERIALS

**BODY:** Brass and Aluminum  
**SHADE:** Aluminum

### WEIGHT

Approx.: 15 kg | 33 lbs

### BULBS (40W)

10 x E14 Bulbs (included)  
(bulbs not included for North America)

### DIMENSIONS

**HEIGHT:** 33" | 85 cm

**Maximum Open DIAM:** 37.4" | 95 cm

**TELESCOPIC TUBE:** 5.9" - 17.7" | 15 - 45 cm

**TELESCOPIC TUBE HEIGHT:** 27.5" | 70 cm  
(customizable on purchase)





# ARETHA

## SUSPENSION LAMP

Drawing inspiration from one of the most acclaimed jazz singers of all time, DelightFULL's designers created Aretha modern chandelier. It is a contemporary reinterpretation of mid-century lighting design classics that were used in the 50s and 60s. The body is 100% handmade in brass and the several bulb holders are made of aluminum. Nickel-plated is the standard finish for the body, while glossy white is used for the sockets. However, the finishes can be customized with any other metal or RAL color of your choosing. This contemporary chandelier can be used in multiple rooms, but it looks especially well when used as a living room chandelier. Also suited for a scandinavian style dining room, this white chandelier features graceful arms that exude a modern charm.

### MATERIALS

**BODY:** Brass

**BULB HOLDER:** Aluminum

### WEIGHT

Approx.: 7 kg | 15.4 lbs

### BULBS (40W)

24 x E14 Bulbs (included)

(bulbs not included for North America)

### DIMENSIONS

**BODY HEIGHT:** 12.2" | 31 cm

**DIAM:** 40.9" | 104 cm

**STANDARD POLE HEIGHT:** 39.4" | 100 cm  
(customizable on purchase)







# ATOMIC

## SUSPENSION LAMP

Atomic light pendant by DelightFULL is a modern design interpretation of the atomic age, inspired by the composition of the atom. Building this unique lighting design using materials such as brass, steel and aluminum, DelightFULL's skilled artisans arranged it in an abstract composition, just like the non-conventional molecular forms. Both a glossy black and a gold plated finish were used for the body, while glossy black and gold powder paint were the chosen finishes for the shades. This stylish suspended ceiling light is the right fit for a contemporary living room, or even for a more modern master bedroom.

### MATERIALS

**BODY:** Brass and Steel  
**SHADES:** Steel

### WEIGHT

Approx: 25 kg | 55.1 lbs

### BULBS (40W)

8x G9 Bulbs  
(bulbs not included for North America)

### DIMENSIONS

**TOTAL HEIGHT:** 47.24" | 120cm  
**BODY HEIGHT:** 28.7" | 73 cm  
**POLE HEIGHT:** 18.5" | 47cm  
**STANDARD CABLE HEIGHT:** 100 cm  
(customizable on purchase)

**DIAM:** 31.5" | 80 cm

**CORD HEIGHT:** Adjustable 39.4" | 100 cm  
(customizable on purchase)





# ATOMIC CEILING

## SUSPENSION LAMP

Atomic ceiling lamp is inspired by the molecular composition of the atom, thus representing a new found interpretation of the mid-century modern era. With a set of spotlights all arranged much like molecular forms, this modern ceiling light comes to redefine what mid-century lighting is all about. Handmade in brass and steel by portuguese artisans, Atomic ceiling light boasts an exquisite gold-plated finish on the body, while the shades are lacquered with a glossy black on the outside and a gold powder paint on the inside. It can be used in a modern entryway, and it also works beautifully as a bedroom ceiling lamp, especially in kids' bedrooms.

### MATERIALS

**BODY:** Brass and Steel  
**SHADES:** Steel

### WEIGHT

Approx: 20 kg | 44 lbs

### BULBS (40W)

8x G9 Bulbs  
(bulbs not included for North America)

### DIMENSIONS

**HEIGHT:** 19.7" | 50 cm  
**DIAM:** 34.6" | 88 cm





# ATOMIC ROUND

## SUSPENSION LAMP

Atomic round chandelier was inspired by the molecular composition of the atom as a nod to the atomic age and race to space mid-century era. DelightFULL's designers created a round set of spotlights all arranged to look like the non-conventional molecular forms. This unique black chandelier is all handmade in brass and steel, with a gold-plated finish on the body and is lacquered with glossy black on the round shades. The inside of the spotlights is lacquered a gold powder paint, in order to create a smoother light to the human eye. The right modern dining room lighting design, Atomic round chandelier cannot be missed. It is also suited for a more scandinavian style living room, being the perfect example of class meets fun.

### MATERIALS

**BODY:** Brass and Steel

**SHADES:** Steel

### WEIGHT

Approx: 25 kg | 55.1 lbs

### BULBS (40W)

12 x G9 bulbs (included)

(bulbs not included for North America)

### DIMENSIONS

**HEIGHT:** 14.6" | 37 cm

**DIAM:** 59" | 150 cm

**STANDARD CABLE HEIGHT:** 100 cm

(customizable on purchase)

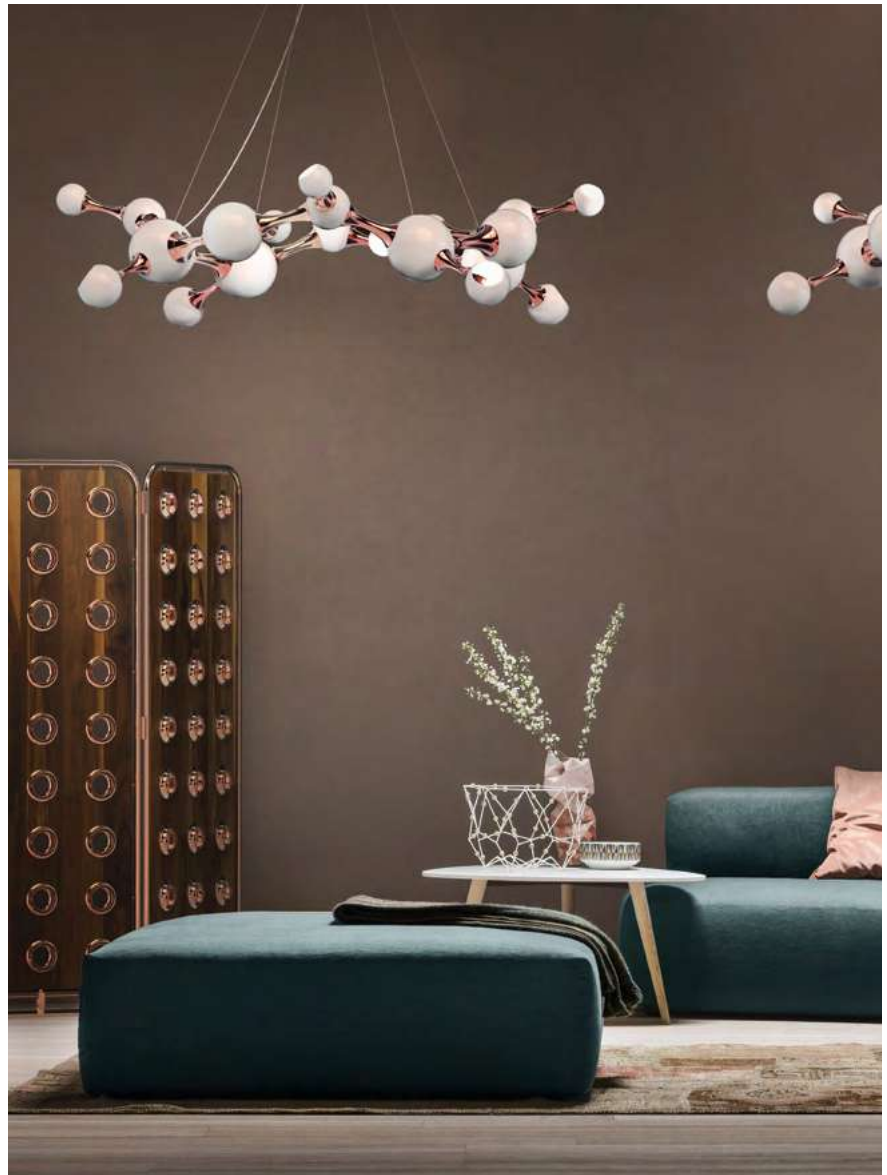



# BASIE

## SUSPENSION LAMP

Basie is a vintage mid-century pendant lamp that brings you a timeless design. Featuring a gold plated body and a matte white shade this white chandelier creates a vintage style that is perfect for any design project. With an elegant and alluring finish, this unique pendant adds a subtle elegance to your dining room lighting. With its body made of brass and its shade of aluminum, it has 39.4 inches of cord height that allows you to create a classic and sophisticated style.

### MATERIALS

**BODY:** Brass

**SHADES:** Aluminum

### WEIGHT

Approx: 20 kg | 44 lbs

### BULBS

2 x G9 LED bulbs

3W / 3000K (included)

(bulbs not included for North America)

### DIMENSIONS

**BODY HEIGHT:** 13.4" | 34 cm

**DIAM:** 23.6" | 60 cm

**STANDARD CABLE HEIGHT:** 100 cm(customizable on purchase)







# BOTTI

## SUSPENSION LAMP

Botti modern chandelier instantly takes us into a music concert starring Chris Botti. The mid-century lighting design was inspired by the American trumpet player as a tribute to jazz music. With a structure handmade in brass and boasting a sophisticated gold-plated finish, this modern ceiling light showcases the high-quality craftsmanship for which DelightFULL is best known for. The brass chandelier goes as tall as 31,5 inches and uses 24 E14 bulbs, which are ingeniously placed at the end of the shades. Its unique shape and design make it the perfect hanging lamp to display on a mid-century modern living room, or a sophisticated hotel lobby.

### MATERIALS

**BODY:** Brass

### WEIGHT

Botti 90 - Approx: 11 kg | 24.3lbs

Botti 150 - Approx: 13 kg | 28.7 lbs

Botti 250 - Approx: 38 kg | 83.8 lbs

### BULBS (40 w)

Botti 90 - 24x E27 Bulbs

Botti 150 - 24x E27 Bulbs

Botti 250 - 24x E27 Bulbs

(bulbs not included for North America)

### DIMENSIONS

#### Botti 90

**HEIGHT:** 24" | 60 cm

**DIAM:** 35" | 90 cm

**POLE HEIGHT:** 27.6" | 70 cm

(customizable on purchase)

#### Botti 150

**HEIGHT:** 31.5" | 80 cm

**DIAM:** 59" | 150 cm

**STANDARD POLE HEIGHT:** 27.6" | 70 cm

(customizable on purchase)

#### Botti 250

### DIMENSIONS

**HEIGHT:** 70.9" | 180 cm

**DIAM:** 98.4" | 250 cm

**POLE HEIGHT:** (customizable on purchase)





# BOTTI

## PENDANT LAMP

Inspired by the american trumpet player Chris Botti as a tribute to jazz music, Botti pendant lamp is a slightly smaller version of the modern chandelier with 15 trumpet-shaped shapes that stretch out from the center, creating a perfect sphere. It is handmade in brass, covered in a gold-plated finish. The round base at the center of the suspended light is handmade in aluminum and lacquered with glossy black, but it can also be lacquered with glossy white to meet the needs of the most exquisite sets. With a retro vibe, this art deco pendant lamp is best suited for a vintage living room, or mid-century modern bedroom.

### MATERIALS

**BODY:** Brass and Steel

### WEIGHT

Botti 12 - Approx: 2,5 kg | 7.7 lbs

Botti 32 - Approx: 4,5 kg | 9.9 lbs

### BULBS (40 w)

Botti 12 - 11 x E27 Silver Crown Bulbs (included)

Botti 32 - 32 x E27 Silver Crown Bulbs (included)

(bulbs E26 not included for North America)

### DIMENSIONS

#### Botti 12

**HEIGHT:** 15.4" | 39 cm

**DIAM:** 16.9" | 43 cm

**STANDARD CORD HEIGHT:** 39.4" | 100 cm (customizable on purchase)

#### Botti 32

**HEIGHT:** 19.7" | 50 cm

**DIAM:** 20.9" | 53 cm

**STANDARD CORD HEIGHT:** 39.4" | 100 cm (customizable on purchase)





# BRUBECK

## SUSPENSION LAMP

Brubeck mid-century modern chandelier is inspired by one of the foremost exponents of cool jazz: Dave Brubeck. This unique lighting design represents the sophistication and finesse of the American jazz pianist, displaying a very luxurious feeling. DelightFULL's skilled artisans handmade this round chandelier in brass, covering it with a gold-plated finish, which can be customized in multiple other finishes. The result of this outstanding creation is a functional dining room chandelier with sculptural shapes. In fact, Brubeck modern chandelier can be tailor-made in multiple shapes and dimensions to best fit your interior design project. Perfect for hospitality projects, like a modern restaurant, or even an art deco hotel lobby.



### MATERIALS

**BODY:** Brass

### WEIGHT

Approx.: 46 kg | 99 lbs

### BULBS (40 w)

30 x G9 Bulbs (included)  
(bulbs not included for North America)

### DIMENSIONS

**BODY HEIGHT:** 17.3" | 44 cm

**DIAM:** 39.3" | 100 cm

**CORD HEIGHT:** 39.4" | 100 cm (adjustable)  
(customizable on purchase)



# BRUBECK

## PENDANT LAMP

Inspired by the American jazz Pianist Dave Brubeck, Brubeck pendant lamp is a great example of when art deco design exceptionally meets music. The result of this outstanding creation is a functional handmade lighting design with a sculptural shape. With a standard body built in brass and a gold-plated finishes, this hanging lamp is available in a wide range of finishes: gold, nickel or copper plated, brushed brass or nickel, and aged brass. It is an art deco brass lamp that will give a retro chic vibe to your new kitchen counter or even mid-century entryway.

### MATERIALS

**BODY:** Brass

### WEIGHT

Approx.: 4,5 kg | 9.9 lbs

### BULBS (40 w)

6 x G9 Bulbs (included)

(bulbs not included for North America)

### DIMENSIONS

**BODY HEIGHT:** 17.3" | 44 cm

**DIAM:** 5.1" | 13 cm

**CORD HEIGHT:** 39.4" | 100 cm (customizable on purchase)







# BRUBECK CHANDELIER

## SUSPENSION

The exponential point in jazz is brought in style by Dave Brubeck. One of the most enchanting mid-century modern chandeliers that DelightFULL has to offer to the world is a statement piece. With an enchanting touch just like everytime Dave Brubeck touched his piano, the charming and alluring effect provided by the spiral case will make this unique lighting design shine in a classic and luxurious living room design or in a lighting hospitality project. Handmade in brass, the care and sleek movements of this modern chandeliers are clear, just like jazz, it never ceases to be timeless.



### MATERIALS

**BODY:** Brass

### DIMENSIONS

**BODY HEIGHT:** 72.17" | 1.83 cm

**DIAM:** 59.06" | 150 cm

**STANDARD CORD HEIGHT:** 59.06" | 100 cm

(customizable on purchase)



# CANNONBALL

## SUSPENSION LAMP

Cannonball light pendant is the perfect explosion of luxury. Inspired by the boldness of a cannonball, this pendant lamp came to reinvent what mid-century modern design is. With its unique shape, this exquisite lamp is handmade in brass and features a gold-plated finish, proof of some of the most high-quality craftsmanship in the lighting design world. It is 51 inches tall, but the height of its steel cord can be customized upon request to fit your interior design concept. Cannonball is a modern brass pendant lamp which will give an elegant and sophisticated touch to your mid-century modern living room.

### MATERIALS

**BODY:** Brass  
**SHADE:** Brass

### WEIGHT

Approx.: 18 kg | 39.6 lbs

### BULBS

48 x G4 LED / 3W Bulbs (included)  
(bulbs not included for North America)

### DIMENSIONS

**DIAM:** 51.1" | 130 cm

**STANDARD CORD HEIGHT:** 39.4" | 100 cm (customizable on purchase)





# CHARLES

## SUSPENSION LAMP

A revival of the mid-century modern design classics, Charles contemporary chandelier is a simple lighting design with a lot of character. It features 20 lampshades, all of them handmade in brass, with perforated details on the top. A copper plated finish is applied to the body of the lamp at the end of the process, creating a more contemporary vibe. The shades are lacquered with glossy black on the outside and a matte white on the inside, helping to create a more comfortable light to the human eye. This copper pendant lighting can also be customized to have more shades, according to your needs. The right contemporary pendant light for a Scandinavian dining room, or a modern living room design.

### MATERIALS

**BODY:** Brass

**SHADE:** Brass

### WEIGHT

Charles 20 - Approx.: 18 kg | 39.6 lbs

Charles 40 - Approx.: 28 kg | 61.6 lbs

### BULBS (40 w)

Charles 20 - 20 x E27 Bulbs (included)

Charles 40 - 40 x E27 Bulbs (included)  
(bulbs not included for North America)

### DIMENSIONS

#### Charles 20

**BODY HEIGHT:** 15.7" | 40 cm

**DIAM:** 39.3" | 100 cm

**STANDARD POLE HEIGHT:** 35.4" | 90 cm  
(customizable on purchase)

#### Charles 40

**HEIGHT:** 31.5" | 80 cm

**DIAM:** 39.3" | 100 cm

**STANDARD POLE HEIGHT:** 35.4" | 90 cm  
(customizable on purchase)





# CLARK

## SUSPENSION LAMP

With an expressive harmonic beauty, Clark modern pendant light is one of DelightFULL's most iconic pieces. This seemingly minimal lamp is handmade in brass, using the classic method of bending the brass twice into a rounded oblong shape, which allows for a bright cast of light. The standard finish is gold-plated, but it can also be customized in copper, nickel, or even receive an aged brass finish. The pole height is also adjustable in order to better fit your decor needs. Clark is a great example of how suspended light can embody all the class of the mid-century modern age. It is the perfect hanging lamp for your modern dining room, mid-century bedroom, or even hotel bar.

### MATERIALS

**BODY:** Brass

### WEIGHT

Clark - Approx.: 7 kg | 15.4 lbs

Clark XL - Approx.: 70 kg | 154.3 lbs

### BULBS (40 w)

Clark - 10x E14 Tubular Bulbs (included)

Clark XL - 24x E27 Bulbs (included)

(bulbs not included for North America)

### DIMENSIONS

**Clark**

**HEIGHT:** 27.5" | 70 cm

**DIAM:** 19.6" | 50 cm

**STANDARD POLE HEIGHT:** 27.5" | 70 cm (customizable on purchase)

**Clark XL**

**HEIGHT:** 110.2" | 280 cm

**DIAM:** 70.9" | 180 cm

**CORD HEIGHT:** 39.4" | 100 cm (adjustable) (customizable on purchase)







# COLTRANE

## SUSPENSION LAMP

Coltrane pendant lamp is one of DelightFULL's top best sellers. With a minimalist and industrial feeling to it, it is not, however, hard to understand where the mid-century inspiration lies. Coltrane is a simple suspended ceiling light, which is handmade in steel. It features a steel cord and a magnetic disc at the top, while down below the canopy is built out of stainless steel, with a gold-plated finish. The shade is also made of steel but it is lacquered a matte gold on the outside and a gold powder paint on the inside. An industrial pendant lighting design fit for the most demanding setting, with a seal of high-quality craftsmanship only delivered by the best artisans in the industry. Coltrane is a great mid-century modern lamp for more minimalist home interiors, as well as for contemporary hotel decor.



### MATERIALS

**WIRE:** Steel Cords and Magnetic Disc (per tube)

**CANOPY:** Brass

**SHADE:** Steel

### WEIGHT

Approx.: 5 kg | 11 lbs (per tube)

### BULBS (40W)

2 x Gu10 (per tube) (included)

(bulbs not included for North America)

### DIMENSIONS

**TUBE DIAM.:** 3.2" | 8 cm

**WIDTH:** 39.4" | 100 cm

**CORD HEIGHT:** 59" | 150 cm (adjustable)

(customizable on purchase)



# CONNOR

## SUSPENSION LAMP

Just like the captivating and endearing voice of Chris Connor, the unique lighting design of Connor ceiling fixture is one of the most lavish and sophisticated lighting designs to attribute to your modern living room. A unique lighting design, with a high level of craftsmanship, the charm and enticement of the American singer is brought to this mid-century modern chandelier. An icon in music, this ceiling fixture will bring an authentic taste and original atmosphere to any minimalist hotel room. Covered in a gold light, the geometric aspects of this mid-century modern inspiration will bring you to a new reality.

**BULBS**

1 x white LED ribbon  
1 x G9 LED

**DIMENSIONS**

**HEIGHT:** 28.35" | 72 cm  
**DIAM:** 39.37" | 100 cm



# COSMO

## SUSPENSION LAMP

Designed as a tribute to the mid-20th century race to space, Cosmo modern chandelier is inspired by space, galaxies and the planets that surround us. It is a memorable lighting fixture, with very unique details that make it the luxurious bespoke design piece that it is. Handmade in brass and steel, the body is covered by a gold-plated finish, while the stainless steel shades are lacquered a glossy black and glossy white on the outside. On the inside they were painted a soothing matte white, which helps to cast the light in a smoother way. The cord height is almost 40 inches, but it can be customized, much like all the other features and finishes in this large pendant lighting design. It is an intricate design piece to put on display at the entrance of a modern hotel, or to use as a modern dining room lighting fixture.

### MATERIALS

**BODY:** Brass  
**SHADE:** Steel

### WEIGHT

Approx.: 24.25 kg | 53.5 lbs

### BULBS (40W)

22x G9 Lamps (included)  
(bulbs not included for North America)

### DIMENSIONS

**TUBE DIAM.:** 59.1" | 150 cm  
**HEIGHT:** 27.5" | 70 cm  
**CORD HEIGHT:** 39.4" | 100 cm (adjustable)  
(customizable on purchase)





# DIANA

## SUSPENSION LAMP

Diana pendant lamp is an industrial-inspired design that embodies all the simplicity and sophistication of the mid-century modern age. It is handmade in brass and aluminum. The body, built out of brass has a standard black nickel plated finish, while the shade features a standard matte red lacquer on the outside. However, it can be customized using any RAL color of your choosing. It has a small switch on the back of the shade, creating a convenient way of switching the light on and off. This industrial pendant lighting design has also a red textile wire, which can be customized as you wish. It is a small suspended light perfect for any contemporary kitchen, but it does also look great as a bedside lamp in an industrial-inspired bedroom.

### MATERIALS

**BODY:** Brass  
**SHADE:** Aluminum  
**WIRE:** Textile

### WEIGHT

Approx.: 5 kg | 11 lbs

### BULBS (40W)

1 x E27 Bulb (included)  
(bulbs not included for North America)

### DIMENSIONS

**WIDTH:** 11.8" | 30 cm  
**HEIGHT:** 19.6" | 50 cm(min) 35.4" | 90 cm(max)  
**LENGTH:** 17.7" | 45 cm







# DORSEY

## SUSPENSION LAMP

Inspired by the acclaimed jazz trumpet player Tommy Dorsey, this mid-century modern chandelier is a unique lighting fixture that embodies the musicality of the 1950s. Allying the best of ancient techniques with the modern expertise of high-craftsmanship, Dorsey is a handmade brass chandelier, with aluminum lamp shades. The telescopic tubes that make up the body boast a gold-plated finish, while the lamp shades and center are lacquered a matte black. It is a unique chandelier, perfect for a mid-century hotel lobby, or an art deco-inspired restaurant. It can also be used in private residences, especially as a dining room lighting fixture.

### MATERIALS

**BODY:** Brass

**SHADE:** Aluminum

### WEIGHT

Approx.: 15 kg | 33 lbs

### BULBS (3W)

40 x E14 Bulb LED / 2700K (included)  
(bulbs not included for North America)

### DIMENSIONS

**WIDTH:** 52.36" | 133 cm

**HEIGHT:** 19.7" | 50 cm

**TELESCOPIC TUBE HEIGHT:** 27.6" | 70 cm (adjustable)  
(customizable on purchase)





# DUKE

## SUSPENSION LAMP

Inspired by the grooviness of the 1970s, DelightFULL has created Duke. This modern chandelier is a simple lighting design with the ability to create an easy going vibe in every home. Handmade in brass and aluminum, it boasts amazing matte black and gold-plated finishes on the body and shades. The lampshades are also lacquered a matte white on the inside. However, all these finishes can be customized with any RAL color of your choosing. This mid-century modern chandelier is a great example of the high-quality craftsmanship for which DelightFULL is known for. It is at its best when used as a dining room lighting solution, but it can be also used in a modern large entryway, or even a grand dining hall at a five-star hotel.

### MATERIALS

**BODY:** Brass  
**SHADE:** Aluminum  
**WIRE:** Textile

### WEIGHT

Duke 6 - Approx.: 9 kg | 19.8 lbs (3 arms)  
 Duke 12 Round - Approx.: 30 kg | 26.4 lbs

### BULBS (40 w)

Duke 6 - 18 x G9 Bulbs (included)  
 Duke 12 Round - 36 x G9 Bulbs (included)  
 (bulbs not included for North America)

### DIMENSIONS

**Duke 6**  
**HEIGHT:** 13.8" | 35 cm  
**WIDTH:** 66" | 168 cm  
**CORD HEIGHT:** 25.6" | 65 cm (adjustable)  
 (customizable on purchase)  
**Cable height between arms:** 11.81" | 30cm

**Duke 12**  
**BODY HEIGHT:** 13.8" | 35 cm  
**DIAM:** 66" | 168 cm  
**POLE HEIGHT:** 39.4" | 100 cm (adjustable)  
 (customizable on purchase)





# ELLA

## SUSPENSION LAMP

Ella round chandelier is a unique ceiling fixture which brings back the clean and sophisticated feelings of the mid-century modern era lived in the 1960's Palm Springs. With a body 100% handmade in brass and its lampshades made of aluminum, this lighting design was reinvented using today's technical skills paired with the traditional craftsmanship and know-how of some of the best portuguese artisans. The body has a nickel plated finish, while the lampshades are lacquered a glossy black for a sleeker look. It is available both in the 6 or 15 arms versions. An iconic mid-century modern chandelier, perfect for a contemporary living room or dining area.

### MATERIALS

**BODY:** Brass

**SHADE:** Aluminum

### WEIGHT

Ella 6 - Approx.: 8 kg | 17.6 lbs

Ella 15 - Approx.: 16 kg | 35.3 lbs

### BULBS (40 w)

Ella 6 - 6 x G9 Bulbs (included)

Ella 15 - 15 x G9 Bulbs (included)

(bulbs not included for North America)

### DIMENSIONS

**Ella 6**

**HEIGHT:** 21.3" | 54 cm

**DIAM.:** 30" | 76 cm

**STANDARD POLE HEIGHT:** 39.4" | 100 cm(adjustable)

(customizable on purchase)

**Ella 15**

**HEIGHT:** 22.8" | 58 cm

**DIAM.:** 50.4" | 128 cm

**POLE HEIGHT:** 39.4" | 100 cm(adjustable)

(customizable on purchase)





# ETTA ROUND

## SUSPENSION LAMP

Inspired by the feminine glow cast by one of the greatest jazz singers of all times, DelightFULL has created Etta round chandelier. It is a sophisticated and very functional chandelier lighting design suited for the most luxurious settings you can think of. It is handmade in brass, with the additional unique feature of each one of its leaves being shaped and assembled by hand. The gold brushed standard finish gives this brass chandelier a true sense of luxury. Seeing as this is a bespoke lighting design, every feature can be altered to meet your expectations and requests. Etta is the perfect chandelier lighting for a luxurious lobby at a five-star hotel, but it also looks amazing in a grand dining hall.

### MATERIALS

**BODY:** Brass

### WEIGHT

Approx.: 40 kg | 88 lbs

### BULBS (40 w)

24 x G9 Bulbs (included)  
(bulbs not included for North America)

### DIMENSIONS

**BODY HEIGHT:** 15.6" | 39 cm

**DIAM:** 39.4" | 100 cm

**STANDARD CORD HEIGHT:** 39.4" | 100 cm (adjustable)  
(customizable on purchase)







# ETTA CHANDELIER

## SUSPENSION LAMP

Etta is a large chandelier inspired by one of the best jazz singers of all times. Being the sophisticated lighting design it is, it boasts a nostalgic and feminine vibe, making it the right choice for every luxurious interior design. Each one of its brass leaves are shaped and assembled by hand by some of the most skilled artisans in Portugal. With a brushed gold standard finish, this bespoke round chandelier can be customized to fit your interior design project. A true example of high-quality craftsmanship, this modern chandelier features four suspended arcs, that together produce a feeling of bliss in every refined living room or grand hall.

### MATERIALS

**BODY:** Brass

### WEIGHT

Approx.: 95 kg | 209 lbs

### BULBS (40 w)

42 x G9 Bulbs (included)  
(bulbs not included for North America)

### DIMENSIONS

**TOTAL BODY HEIGHT:** 50" | 127 cm

**DIAM:** 45.3" | 115 cm

**STANDARD CORD HEIGHT:** 39.4" | 100 cm  
(adjustable) (customizable on purchase)





# ETTA

## PENDANT LAMP

Etta pendant lamp boasts a nostalgic and feminine retro glow, courtesy of the jazz singer Etta Jones, which was the inspiration for this curvy lighting fixture. Etta is a luxurious pendant light with 20 different brass leaves, which are all shaped and assembled by hand by DelightFULL's skilled artisans. Etta's standard copper plated finish helps to provide a soft and warm light, that is cast through its layers, giving a romantic ambiance to any setting. Nevertheless, keep in mind that this mid-century suspended light can be customized according to your needs and requests. It is the ideal copper pendant lamp for a sophisticated kitchen design, but it can also be used as a suspended bedside lamp.

### MATERIALS

**BODY:** Brass

### WEIGHT

Approx.: 9.5 kg | 20.9 lbs

### BULBS (40 w)

4 x G9 Bulbs (included)  
(bulbs not included for North America)

### DIMENSIONS

**BODY HEIGHT:** 23.6" | 60 cm  
**DIAM:** 11.8" | 30 cm  
**CORD HEIGHT:** 39.4" | 100 cm (adjustable)  
(customizable on purchase)





# GALLIANO ROUND

## SUSPENSION LAMP

Galliano round chandelier is a mid-century modern light with a shape that was inspired by a pipe organ. With sculptural shapes and an extremely balanced design, this modern lighting design gets even more beautiful when you see the light being casted through its pipes. It's possible to customize this chandelier lighting in any shape or dimension: round, oval, square or rectangular. Handmade in steel, the features include a nickel plated finish applied by some of the finest artisans in Portugal. The interior of the lamp shades are in white matte, enhancing the lighting design with a perfect mix of form and function. Ideal to use as a modern dining room lighting fixture or as an entrance lighting, Galliano has a mid-century modern appeal that won't go unnoticed.

### MATERIALS

**BODY:** Steel

### WEIGHT

Approx.: 60 kg | 132 lbs

### BULBS (40 w)

70 x G9 Bulbs (included)  
(bulbs not included for North America)

### DIMENSIONS

**BODY HEIGHT:** 15.7" | 40 cm

**DIAM.:** 31.5" | 80 cm

**CORD HEIGHT:** 39.4" | 100 cm (adjustable)  
(customizable on purchase)





# GALLIANO

## PENDANT LAMP

Galliano black pendant lamp features a modern, sleek design that will complement the decor in any setting. This beautiful uniquely design industrial pendant lighting is simply one of DelightFULL's top best sellers. Up to 5 tubes and with a structure tailor-made in steel, Galliano produces a unique and gorgeous lighting effect. The body is covered by gold-plated interior finish, while on the outside they were painted a matte black, which provides a unique pendant lamp. Clean lines and mid-century modern vibe combined with versatility make Galliano a useful delight. All in all, this pendant ceiling light is ideal for a variety of residential and commercial application including industrial kitchens, living rooms, bars and restaurants.

### MATERIALS

**BODY:** Steel

### WEIGHT

Approx.: 3 kg | 6.6 lbs

### BULBS (40 w)

6x E27 Bulbs (included)  
(bulbs not included for North America)

### DIMENSIONS

**HEIGHT:** 20.5" | 52 cm

**DIAM.:** 6.3" | 16 cm

**POLE HEIGHT:** 39.4" | 100 cm (adjustable)  
(customizable on purchase)







# HANK

## SUSPENSION LAMP

Inspired by the iconic mid-century era, Hank suspension light brings a graceful, organic shape to any room. Perfect for a mid-century modern interior, this lighting design offers the open look that is a great choice for today's demand of stylish interior. This dazzling lamp has its body in brass and its shade in aluminum. It's stunning telescopic tube has 27, 5" | 70 cm and its body is gold plated as its shade with black matte makes this an irresistible selection. When it comes to décor, this marvelous and inspiring piece is highly recommended in a mid-century hotel lobby or living room.

### MATERIALS

**BODY:** Brass

**SHADES:** Aluminum and Brass

### BULBS (40W)

20 x E14 Bulbs (2 per shade - included)  
(bulbs not included for North America)

### DIMENSIONS

**DIAM.:** 55.1" | 140 cm

**HEIGHT:** 36.2" | 92 cm

**TELESCOPIC TUBE HEIGHT:** 27.5" | 70 cm  
(customizable on purchase)





# HANNA CHANDELIER

## SUSPENSION LAMP

Hanna modern chandelier is a breathtaking lighting design that is made in brass and aluminum with gold plated and white matte shades. Pair it with a modern or contemporary decor as a chic accent piece. This white chandelier is the perfect lighting option to compliment vintage and industrial decors. The gold plated finishes will add the final touches to any home decor. With 25 hanging lights suspended on black cord cables we recommend you E27 Bulbs. Inspired by the mid-century modern era, it can be used with the dimmer to achieve your desired effect.

### MATERIALS

**BODY:** Brass

**SHADES:** Aluminum and Brass

### WEIGHT

Approx.: 67 kg | 147 lbs

### BULBS (40W)

25 x E27 Bulbs (1 per shade - included)  
(bulbs not included for North America)

### DIMENSIONS

**DIAM.:** 39.4" | 100 cm

**HEIGHT:** 35.4" | 90 cm

**CORD HEIGHT:** 43.3" | 110 cm  
(customizable on purchase)





# HANNA

## CEILING LAMP

Hanna is a vintage lighting fixture that is elegantly by five arms and five lamp shades made in brass. Each lampshade can be adjusted to direct lighting over a wide reaching area. With a gold plated and a matte white finish ( inside and outside), each light has a bell shaped shade fashioned from aluminum. Live up your home setting with this classic pendant light, that will suit superbly in a mid-century modern living room or dining room.

All in all, Hanna suspension lamp has flowing lines and a sleek surface that mixed unusual-shaped arms create a vintage lighting design like any other.



### MATERIALS

**BODY:** Brass

**SHADES:** Aluminum and Brass

### WEIGHT

Approx.: 18 kg | 39.6 lbs

### BULBS (40W)

5x E27 Bulbs (included)

(bulbs not included for North America)

### DIMENSIONS

**Maximum Open DIAM:** 19.7" | 50 cm

**HEIGHT:** 47.2" | 120 cm

(customizable on purchase)



# HENDRIX

## CEILING LAMP

With a shape that was inspired by a golden vinyl player, Hendrix ceiling lamp is a tribute to the American rock guitarist, singer, and songwriter: Jimi Hendrix. This gold plated luminaire captures your attention letting you feel the acoustics of the bright Hendrix guitar and reminding us the high fidelity audio reproductions. The open, structured look of this ceiling light is a great choice for a stylish mid-century modern interior. The arms are adjustable, allowing you to create personalized looks. Finished in gold plated and black matte with a brass structure, each arm of this contemporary chandelier takes 9 x G9 bulb (included). With a customizable and adjustable pole height, Hendrix fixture can be mounted on a sloped ceiling.

### MATERIALS

**BODY:** Brass

**SHADES:** Brass

### WEIGHT

Hendrix 3 - Approx.: 20 kg | 44 lbs

Hendrix 5 - Approx.: 35 kg | 77 lbs

### BULBS (40 w)

Hendrix 3 - 9 x G9 Bulbs (included)

Hendrix 5 - 15 x G9 Bulbs (included)  
(bulbs not included for North America)

### DIMENSIONS

#### Hendrix 3

**DIAM.:** 65" | 165 cm

**HEIGHT:** 13.8" | 35 cm

**POLE HEIGHT:** 39.4" | 100 cm  
(customizable on purchase)

#### Hendrix 5

**DIAM.:** 65" | 165 cm

**HEIGHT:** 13.8" | 35 cm

**POLE HEIGHT:** 39.4" | 100 cm  
(customizable on purchase)







# HENDRIX

## CHANDELIER LAMP

Inspired by the millions of vinyl records sold by the famous American guitarist, DelightFULL has created this elegant gold-plated luminaire. Proof that high-quality craftsmanship and ancient know-how can create stunning lighting fixtures, Hendrix pendant lamp has come to revolutionize the mid-century lighting design world. Its simple geometry was designed to ensure that all the five gold-plated brass tiers are struck by the rays of light in the same angle, creating a glare-free illumination. The light is pushed downward in the funnel, where it is then dispersed, leaving a soft glow directly under it at the same time it bounces back some of the lighting power upward on the dome. This ensures the creation of a warm and cozy atmosphere, perfect for a mid-century living room decor, or even a more contemporary entryway.



### MATERIALS

**BODY:** Brass

### WEIGHT

Approx.: 35 Kg | 77 lbs

### BULBS (40W)

15 x G9 Bulbs (bulbs not included for North America)

### DIMENSIONS

**BODY HEIGHT:** 19.7" | 50 cm

**DIAM.:** 27.2 | 69 cm

**STANDARD CORD HEIGHT:** 39.4 | 100 cm (customizable on purchase)



# IKE

## SUSPENSION LAMP

Ike suspension lamp has a distinctive but easily recognizable design, ideal for every single mid-century modern interior. With its clean lines, this dazzling lamp is handmade in brass and aluminum and features a glossy black and gold plated finish, representing a high-quality craftsmanship. It is 15 inches tall, but its steel cord can be customizable on purchase, being adjustable up to 39.4 inches. Highly recommended to use with a dimmer switch to cast a smoother light, this modern brass lamp is perfect as a dining room chandelier lighting or to be used in a hotel lobby.

### MATERIALS

**BODY:** Brass

**SHADES:** Brass and Aluminum

### WEIGHT

Approx.: 9.5 kg | 21 lbs

### BULBS (40W)

13 x G9 Bulbs (included)

(bulbs not included for North America)

### DIMENSIONS

**BODY HEIGHT:** 15" | 38 cm

**DIAM.:** 23.6" | 60 cm

**CORD HEIGHT:** 39.4" | 100 cm(adjustable)

(customizable on purchase)





# JACKSON

## SUSPENSION LAMP

A precise addition for your mid-century modern interior, Jackson brass chandelier has a sleek design that will augment your existing decor. Handmade in brass with a gold plated and black matte finishes, this modern chandelier shows off 6 stunning lights to bring depth to your interior space. Going as high as 11,8 inches, its steel cord can be customizable on purchase. This mid-century chandelier also features a textile red wire in every single lamp shade, providing updated allure with an unmistakably design that you won't resist. Over a dining room table or as an entry chandelier, Jackson lamp is an inspired choice.

### MATERIALS

**BODY:** Brass  
**SHADES:** Aluminum and Brass  
**WIRE:** Textile

### WEIGHT

Approx.: 15 kg | 33 lbs

### BULBS (40W)

6 x Gu10 Bulbs (included) (for USA not included)

### DIMENSIONS

**HEIGHT:** 11.8" | 30 cm  
**DIAMETER:** 39.3" | 100 cm  
**TELESCOPIC TUBE:** 11.8" - 23.6" | 30 - 60 cm  
**TELESCOPIC TUBE HEIGHT:** 27.5" | 70 cm  
 (customizable on purchase)

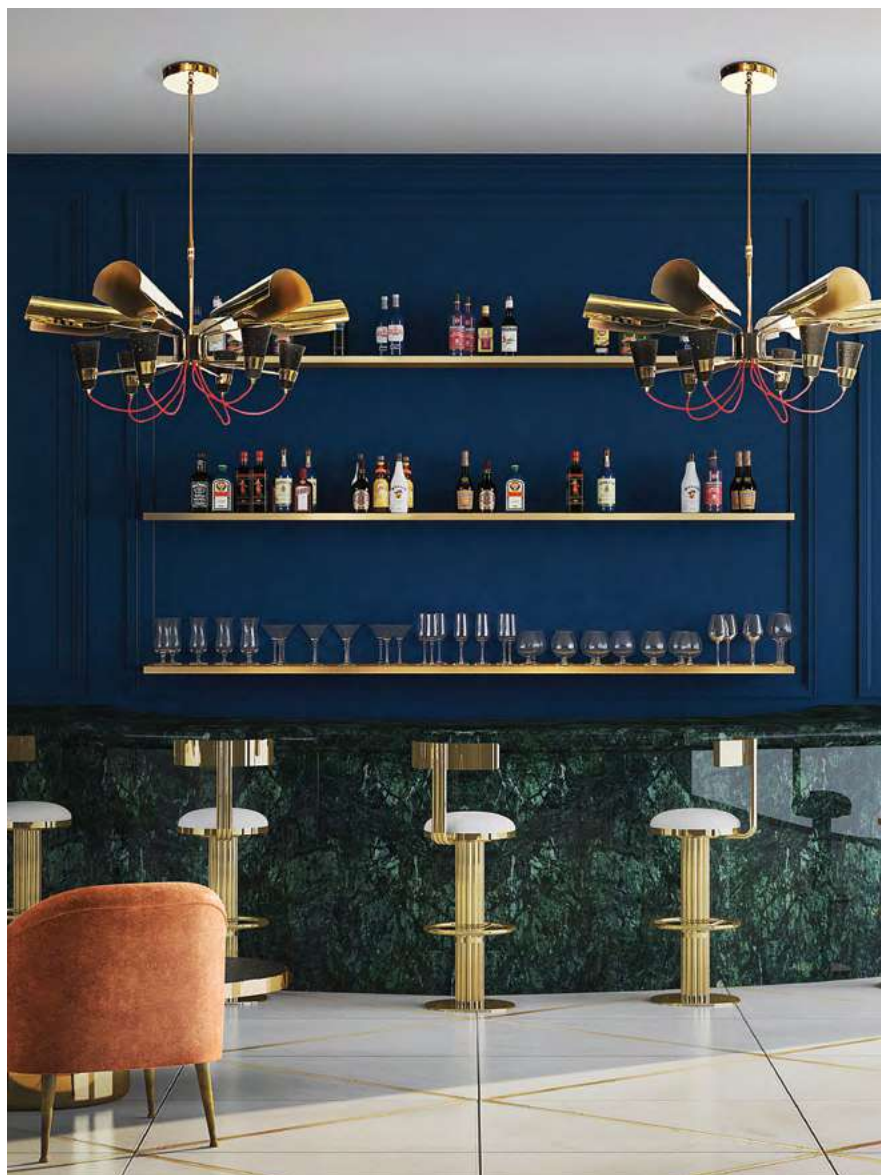



# KRAVITZ

## PENDANT LAMP

Inspired by the big afro hair styles that popularized the 60s, Kravitz modern chandelier is also a tribute to the bold, multiple award winning rock star, Lenny Kravitz. This unique chandelier has a series of tubes in a circular pattern trimmed to be shaped like a ball. With a structured handmade in aluminum, Kravitz features a matte black exterior and a gold powder paint interior finishing. Kravitz hanging light is a funky modern chandelier that will look perfect as centerpiece to hang over a dining room table or as an entry light fixture.



### MATERIALS

**BODY:** Aluminum

### WEIGHT

Approx.: 50 kg | 110 lbs

### BULBS (1W)

86 x CREE LED

### DIMENSIONS

**HEIGHT:** 25.6" | 65cm

**DIAMETER:** 24.4" | 62 cm

**CORD HEIGHT:** 39.4" | 100 cm(adjustable)  
(customizable on purchase)





# LAINE

## SUSPENSION LAMP

DelightFULL's designers created Laine suspension lamp with the mid-century vibe in mind. Inspired by the iconic era that brought so much culture to the world, this set of spotlights arranged like magic in your home, this modern ceiling light comes to redefine what mid-century lighting is all about. With its body made of brass and its shade of aluminum, it's simply poetic and extravagantly scenic. Delicate telescopic tubes with its body in gold plated color and its shade in glossy white, it will only add beauty and a classical touch to your interior design.

### MATERIALS

**BODY:** Brass  
**SHADE:** Aluminum

### BULBS (40W)

6 x E14 Bulbs LED (included) (for USA not included)

### DIMENSIONS

**LENGTH:** 68.9" | 175 cm  
**WIDTH:** 68.9" | 175 cm  
**HEIGHT:** 15.3" | 39 cm





# MADELEINE

## SUSPENSION LAMP

Inspired by a flower bouquet, DelightFULL's designers designed Madeleine, an industrial pendant lighting. With four cone swiveling pinhole lights, this brass pendant lamp features a matte white interior and a gold powder paint inside finishing. This white pendant light is also possible to have with an adjustable drawbar so that you can move it anytime. Madeleine is 15,5 inches tall, but it can be customizable on purchase, being adjustable up to 39,4 inches. Madeleine can complement many lofts, bars and restaurants, however this pendant light can go anywhere, adding an industrial style touch to whatever room you decide to hang it in.

### MATERIALS

**BODY:** Brass  
**SHADE:** Aluminum

### WEIGHT

Approx.: 3.3 kg | 7.2 lbs

### BULBS (40 w)

4 x E27 Bulbs (included) (E26 for USA not included)

### DIMENSIONS

**DIAM.:** 16" | 40 cm

**HEIGHT:** 15.5" | 39 cm

**POLE HEIGHT:** 39.4" | 100 cm (adjustable)

(customizable on purchase)





# MATHENY

## SUSPENSION LAMP

Feel the true statement of luxury with this modern ceiling lamp. Matheny is a unique chandelier, a new take on the mid-century classics. It has a geometric design of combined tubes and its structure is handmade in brass. Its shape is round and is composed by golden tubes, which reflect the sophistication of a timeless iconic lamp. With 110 pounds, this luxurious chandelier light can be used in a modern living room or as a modern dining room lighting. All in all, Matheny round chandelier will certainly capture the attention of your guests.



### MATERIALS

**BODY:** Brass

### WEIGHT

Approx.: 50 kg | 110 lbs

### BULBS (40 w)

24 x G9 Bulbs (included) (for USA not included)

### DIMENSIONS

**DIAM.:** 39.4" | 100 cm

**HEIGHT:** 11.8" | 30 cm

**CORD HEIGHT:** 39.4" | 100 cm (adjustable)  
(customizable on purchase)



# MATHENY

## PENDANT LAMP

Matheny hanging lamp is the ultimate lighting design in Heritage collection. DelightFULL's designers have decided to create a mid-century modern lamp with a minimalist design that makes a big statement. The gold plated finish makes Matheny pendant light an instant classic that will look beautiful in every division of your interior design. The fine brass structure of this suspended light becomes translucent when lit, adding a chic and contemporary touch to a kitchen island or dining table. In a hallway or over a bar, this golden pendant light can be hung in multiples for a stylish effect.

### MATERIALS

**BODY:** Brass

### WEIGHT

Approx.: 4 kg | 8.8 lbs

### BULBS (40 w)

6 x G9 Bulbs (included) (for USA not included)

### DIMENSIONS

**DIAM.:** 7" | 18 cm

**HEIGHT:** 11.8" | 30 cm

**CORD HEIGHT:** 39.4" | 100 cm (adjustable)  
(customizable on purchase)







# NEIL

## SUSPENSION LAMP

Neil is a modern chandelier with round arcs and spherical diffusers, that were inspired by the golden years of space exploration in the 60's. It has 8 arms with rotating spheres to cast light to wherever you need in order to create the perfect mood - a rare feature on chandeliers. Therefore, this iron chandelier casts ambient light in all directions. It also offers the choice of having only 4 of the 8 diffusers lit on. With a structure handmade in iron and 8 lamp shades in iron, Neil black chandelier has a mid-century modern design with glossy black exterior and a matte black interior finishing. Ideal as a modern dining room lighting or as a centerpiece in your mid-century living room, Neil will add an innovative touch to your interior design.

### MATERIALS

**BODY:** Brass  
**SHADE:** Steel

### WEIGHT

Approx.: 15 kg | 33 lbs

### BULBS (40 w)

8 x E27 Bulbs (included) (E26 for USA not included)

### DIMENSIONS

**DIAM.:** 47.3" | 120 cm

**HEIGHT:** 23.6" | 60 cm

**POLE HEIGHT:** 7.9" - 23.6" | 20 - 60 cm (adjustable)  
(customizable on purchase)





# NORAH

## SUSPENSION LAMP

Norah is a mid-century modern lighting design that was inspired by the 50s decor. This modern sputnik chandelier light is the perfect combination of a mid-century modern design and a minimalist design. The standout feature on this 17-light brass chandelier finished in nickel plated is the delicate form of Norah's arms. A glossy black finish blends well with naked light bulbs for a refined and more personalized look. The bulb holders in aluminum can be customized in any RAL color of your choosing. This brass chandelier can serve as an accent piece in a wide range of styles, but it will look better if you use it in your Scandinavian style living room.

### MATERIALS

**BODY:** Brass

**BULB HOLDER:** Aluminum

### WEIGHT

Approx.: 5,8 kg | 12,8 lbs

### BULBS (40 w)

17 x E14 Bulbs (included) (E12 for USA not included)

### DIMENSIONS

**HEIGHT:** 7.9" | 20 cm

**DIAM.:** 38.2" | 97 cm

**POLE HEIGHT:** 27.5" | 70 cm

(customizable on purchase)





# PEGGY

## SUSPENSION LAMP

Peggy modern chandelier has a 60's feel that won't go unnoticed. With a structure handmade in brass and wood and with a top cover in perforated steel, this unique lamp has a nickel plated and matte white finish. The dazzling lighting design lamp shades are in matte black, making an incredible contrast with the matte white top cover, that characterizes this contemporary chandelier. With almost 18 pounds, Peggy chandelier light also offers the choice of having only 4 of the 8 diffusers lit on. Peggy is a great modern lighting solution for your living room decor and can also be used as a modern dining room chandelier.



### MATERIALS

BODY: Brass and Wood

SHADE: Aluminum

TOP COVER: Steel

### WEIGHT

Approx.: 8 kg | 17.6 lbs

### BULBS (40 w)

8 x E14 Reflector Bulbs (included)

(E12 for USA not included)

### DIMENSIONS

HEIGHT: 20" | 51 cm

DIAM.: 41.3" | 105 cm

POLE HEIGHT: 39.4" | 100 cm

(customizable on purchase)



# SIMONE

## SUSPENSION LAMP

Nina Simone was the inspiration for this dazzling mid-century modern chandelier. Handmade in brass, this modern lamp has three lamp shades in aluminum that feature a glossy black finish and three visible textile red wires above the large lamp shades. This retro style chandelier is 35 inches tall and the pole height is 19.7", but it can be customizable on purchase. The three arms are united by a gold plated ring, showing a high level craftsmanship. The big lampshades, the asymmetric structure, the visible textile wire and the nickel plated details have resulted in a huge pendant lamp which will surely put a spell on you.



### MATERIALS

BODY: Brass and Wood

SHADE: Aluminum

WIRE: Textile

### WEIGHT

Approx.: 7 kg | 15.4 lbs

### BULBS (40 w)

3 x E27 Bulbs (included)

(bulbs not included for North America)

### DIMENSIONS

BODY HEIGHT: 35.4" | 90 cm

DIAM.: 43.3" | 110 cm

STANDARD POLE HEIGHT: 19.7" | 50 cm

(customizable on purchase)





# SINATRA

## SUSPENSION LAMP

Sinatra is a modern chandelier that was inspired by Frank Sinatra's song "New York, New York". Handmade in brass and with a nickel plated finish, Sinatra reflects the popular classics from the mid-century period of design.

The three lamp shades have a distinctive appearance crafted in aluminum and have a glossy red finish. The counterweights are made of iron and have also a glossy red finish. Both these features can be customized in every RAL color of your choosing.

With the possibility of having 1 to 5 moveable arms, this mid-century chandelier is suitable for the most demanding setting. Ideal for your mid-century home design, Sinatra can serve as a centerpiece in a wide range of decors.

### MATERIALS

BODY: Brass  
SHADE: Aluminum  
COUNTER WEIGHT: Steel

### WEIGHT

Approx.: 15 kg | 33 lbs

### BULBS (40 w)

3 x E27 Bulbs (included)  
(bulbs not included for North America)

### DIMENSIONS

TOTAL CENTRAL ROD HEIGHT  
(from the bottom to the connection  
with adjustable point): 23.62" | 60 cm  
ADJUSTABLE POLE HEIGHT: (customizable on purchase)  
Maximum Open DIAM: 43.3" | 110 cm





# STANLEY

## SUSPENSION LAMP

Stanley retro pendant lamp is inspired by some of the most iconic lighting designs of the 1960s. It is handmade in brass and aluminum, with a nickel plated finish on the body, and glossy black lacquer on the outer part of lampshades. The inside is lacquered a matte white. With three adjustable arms, this mid-century modern lighting fixture has three counterweights all built in iron. All these features can be customized by request to include different finishes and any RAL color of your choosing. A modern light pendant that embodies all the best from the from the 50s and 60s interior design style, which looks amazing in any mid-century dining room, or a colorful kitchen.

### MATERIALS

BODY: Brass  
SHADE: Aluminum  
COUNTER WEIGHT: Steel

### WEIGHT

Approx.: 15 kg | 33 lbs

### BULBS (40 w)

3 x E27 Bulbs (included)  
(bulbs not included for North America)

### DIMENSIONS

TOTAL CENTRAL ROD HEIGHT  
(from the bottom to the connection  
with adjustable point): 23.62" | 60 cm  
ADJUSTABLE POLE HEIGHT: (customizable on purchase)  
Maximum Open DIAM: 43.3" | 110 cm





# TURNER

## PENDANT LAMP

Inspired by the astonishing and memorable dance moves of the iconic pop singer, DelightFULL's design team created the Turner family. Turner pendant lamp is an art deco lighting fixtures handmade in brass and aluminum that boasts all the most special elements of this design movement. The body has five gold plated finished movable arcs, which can all be rotated into the desired position, giving this modern pendant lamp a sense of fun. The small shade on the center is lacquered a matte white, but it is customizable with any RAL color of your choosing. Turner hanging light is a versatile piece, that can be used in almost any room of your house. However, it looks its best when used as an alternative bedside lamp, or when placed in an art deco inspired living room.

### MATERIALS

BODY: Brass  
SHADE: Aluminum

### WEIGHT

Approx.: 3.5 kg | 7.7 lbs

### BULBS (40 w)

1 x E27 Bulbs (included)  
(bulbs not included for North America)

### DIMENSIONS

HEIGHT (Body): 26.7" | 68 cm  
WIDTH: 11.8" | 30 cm  
LENGTH: 11.8" | 30 cm  
CORD HEIGHT: Adjustable



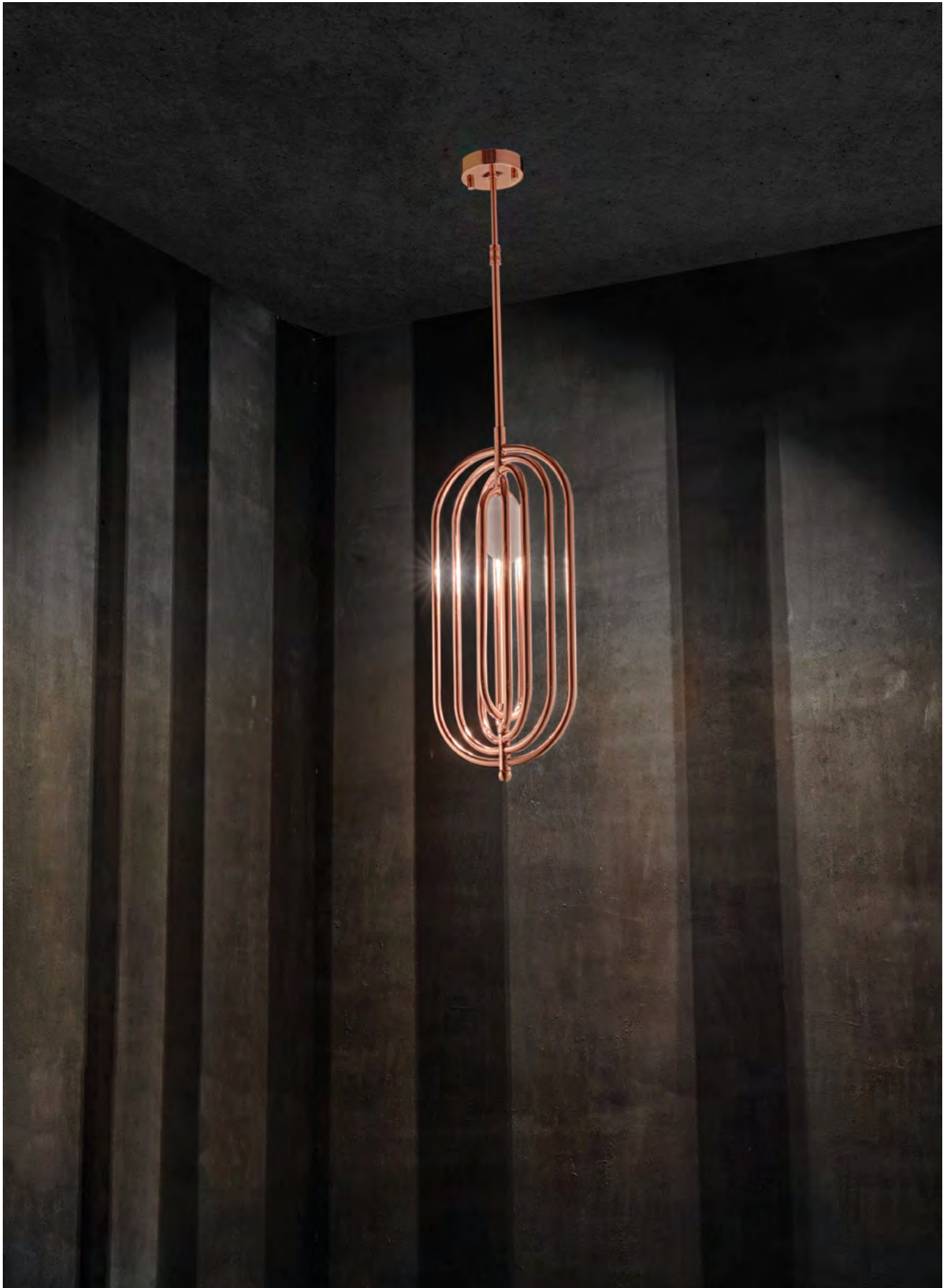



# FLOOR





# AMY

## FLOOR LAMP

Amy vintage floor lamp was inspired by the great jazz singer and songwriter: Amy Winehouse. Amy has a vintage retro style that embodies the soul of the British artist and the 50's interior design style. With a glossy black lamp shade that bear a resemblance to Amy's legendary hair and a small gold powder paint detail that recall us of her golden earring, the brass floor light suits the most demanding mid-century modern setting.

The flexible lamp shade is what makes this modern lamp, the perfect reading light for your vintage bedroom or retro home office, since it will point in any direction you need. Note that Amy floor lamp features a footswitch that is on the cord, and the brass detail on the lamp shade has the sole purpose of adding a more modern aesthetics feeling.

### MATERIALS

**BODY:** Brass and Steel

**SHADE:** Aluminum

### WEIGHT

Approx.: 6,5 kg | 14.3 lbs

### BULBS (40 w)

2 x E14 Bulbs (included)

(bulbs not included for North America)

### DIMENSIONS

**WIDTH:** 11.8" | 30 cm

**HEIGHT:** 59" | 150 cm

**DEPTH:** 15.7" | 40 cm

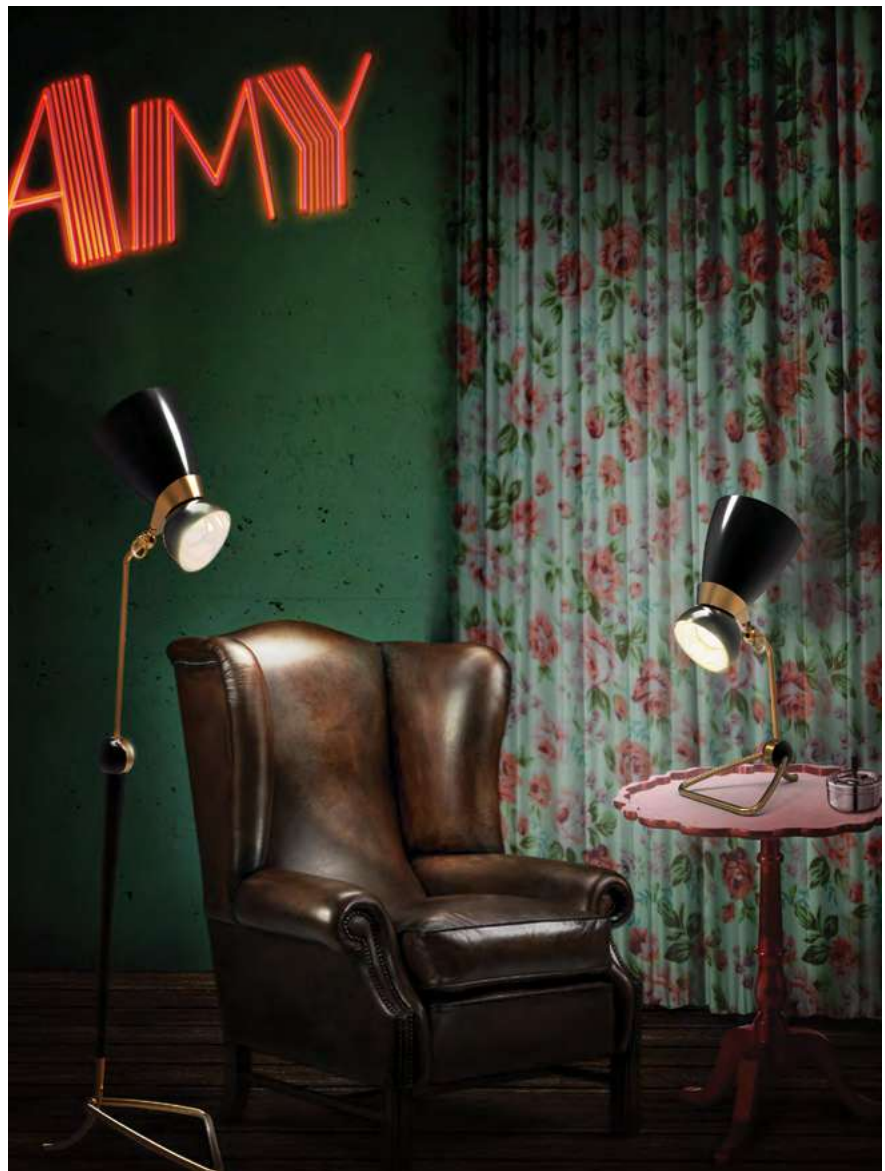



# ARMSTRONG

## FLOOR LAMP

Inspired by the first person to walk on the Moon, Armstrong arc floor lamp has a minimalistic style with a clear usability, perfect for every single modern Scandinavian living room or office. This nordic light combines a mid-century design with a structure handmade in brass and a base in white Carrara marble. The oval aluminum lamp shade is softened with a matte white finish. Armstrong arc lamp can reach a height of 59.1 inches with the help of the adjustable balance arm.

With a counterweight made in steel, this mid-century lamp directs light anywhere a task light is needed, providing an exquisite touch to your interior design.



### MATERIALS

**BODY:** Brass  
**SHADE:** Aluminum  
**BASE:** Carrara Marble (Polished)  
**COUNTER WEIGHT:** Steel

### WEIGHT

Approx.: 13,5 kg | 29.8 lbs

### BULBS (40 w)

4 x G9 Bulbs (included)  
 (bulbs not included for North America)

### DIMENSIONS

**WIDTH:** 47.2" | 120 cm  
**HEIGHT:** 59.1" | 150 cm  
**DEPTH:** 13.8" | 35 cm



# BOTTI

## FLOOR LAMP

Botti is the newest version of Botti family: it embodies all the details of wind instruments, transporting us to a real music concert. Its structure is handmade in brass and gently covered by a golden mantle. This outstanding piece has eight spotlights which offer a soft lighting, attributing simultaneously a cozy and sophisticated ambiance to any setting.

### MATERIALS

**BODY:** Brass  
**SHADE:** Brass

### WEIGHT

Approx.: 18 kg | 39.7 lbs

### BULBS (40 w)

8 x E14 Reflector Bulbs (included)  
(bulbs not included for North America)

### DIMENSIONS

**HEIGHT:** 70.9" | 180 cm  
**DEPTH:** 24.8" | 63 cm

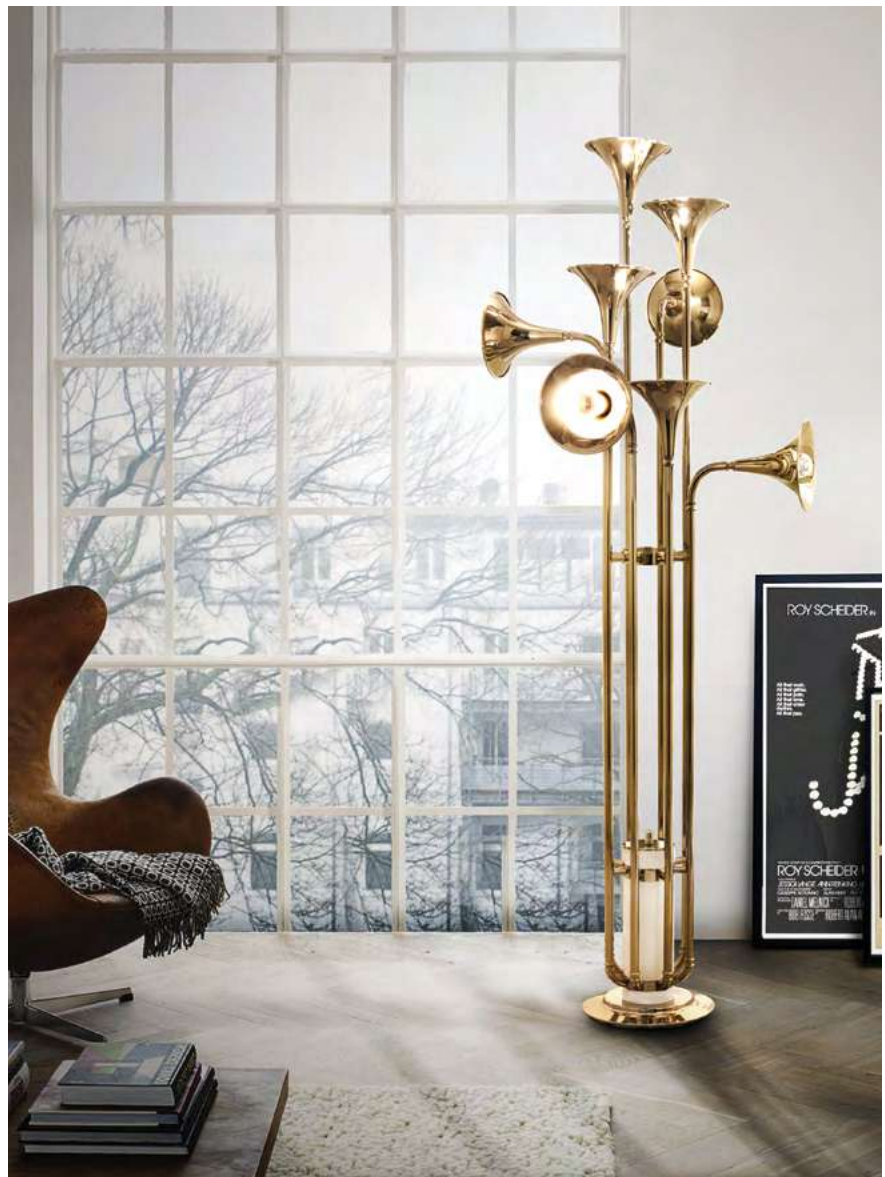



# BRUBECK

## FLOOR LAMP

Dave Brubeck was the inspiration for one of DelightFULL's more luxurious floor lamps. The art deco floor lamp represents in every single detail the way the jazz pianist musician blended very demanding rhythmic structures with improvisation in expressive and accessible ways.

Therefore, in this lighting design you can find asymmetrical gold plated tubes in order to attribute a contemporary lighting effect. However, you can customize this modern floor light, since there is available a wide range of finishes: gold, nickel or copper plated, brushed brass or nickel, aged brass or any RAL lacquered color of your choosing. The base of this mid-century modern lamp is handmade in steel with a matte black finish.



### MATERIALS

**BODY:** Brass

**SHADE:** Steel

### WEIGHT

Approx.: 22 kg | 48.5 lbs

### BULBS (40 w)

6 x E27 Bulbs (included)

(bulbs not included for North America)

### DIMENSIONS

**HEIGHT:** 65.7" | 167 cm

**DEPTH:** 13" | 33 cm

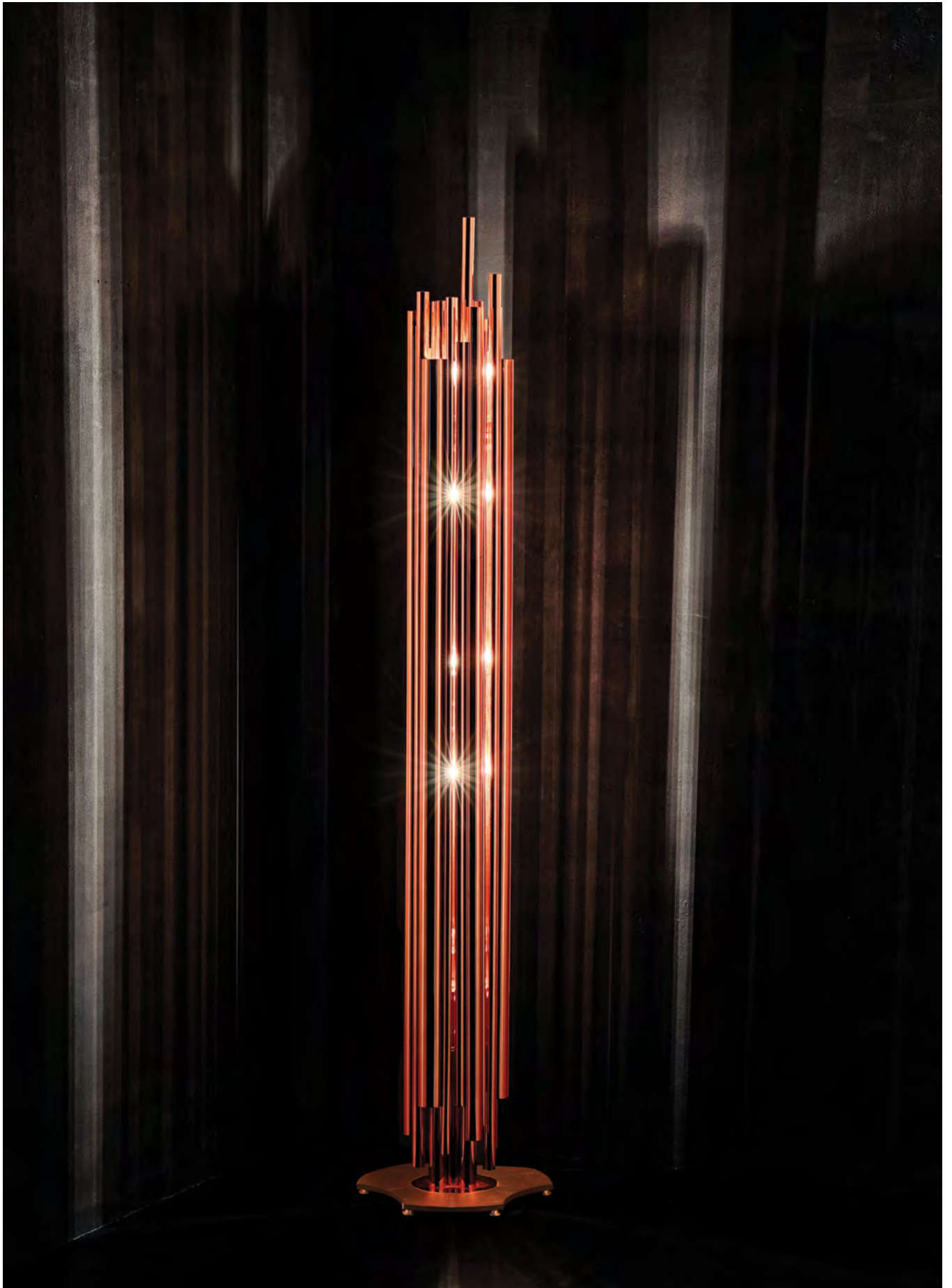



# COLE

## FLOOR LAMP

Cole is a retro-inspired floor lamp that has a three-shade design with a glossy black exterior and a matte white interior finishing.

The three cone shades provide plenty of style as well as flexible lighting.

Therefore, these adjustable heads Cole ensure maximum lighting, depth and add functionality to every single clean and modern design.

With three asymmetrical arms, Cole floor light has a balanced elegance and presence that won't go unnoticed.

This mid-century modern lamp provides brilliant light for any vintage industrial office or living space.

### MATERIALS

**BODY:** Brass

**SHADE:** Aluminum

### WEIGHT

Approx.: 13 kg | 28.7 lbs

### BULBS (40 w)

3 x E27 Bulbs (included)

(bulbs not included for North America)

### DIMENSIONS

**WIDTH:** 17.7" | 45 cm

**HEIGHT:** 76" | 193 cm

**DEPTH:** 13.8" | 35 cm

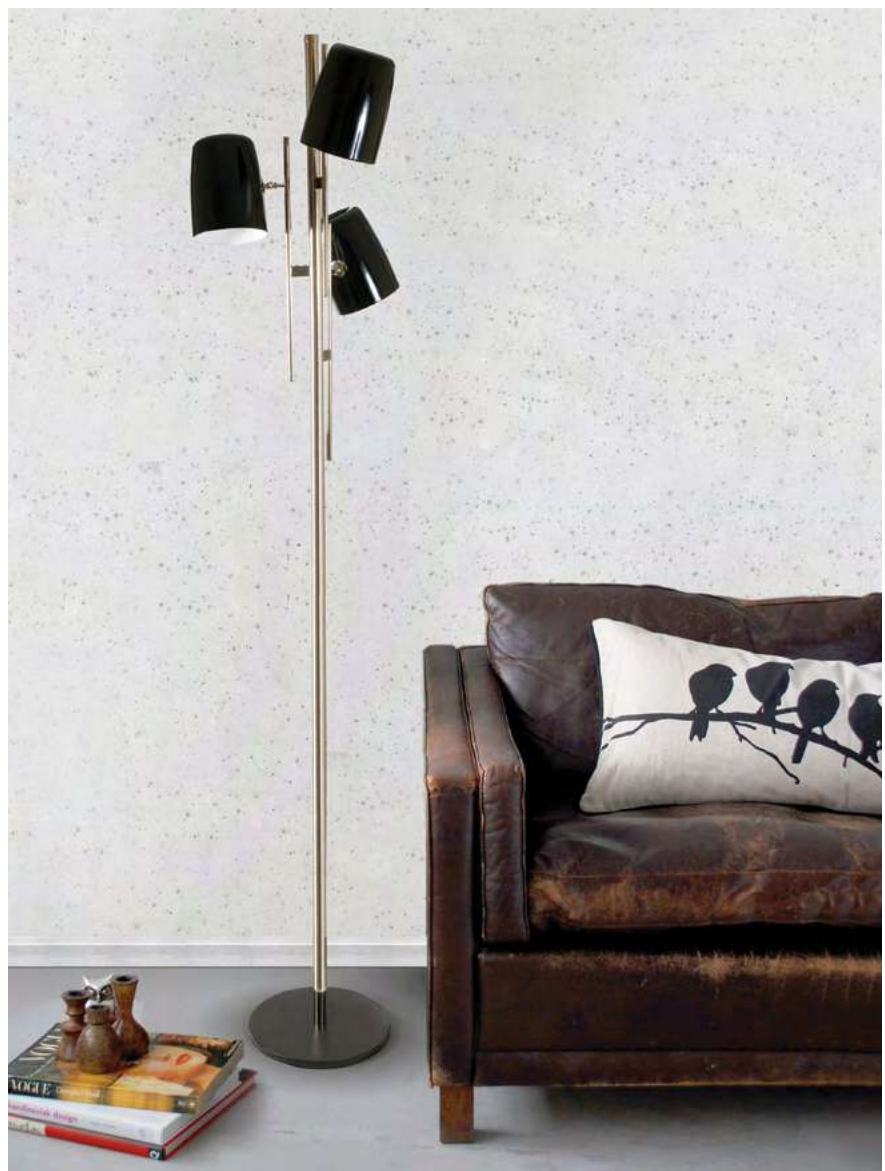



# COLEMAN

## FLOOR LAMP

Coleman is the ideal mid-century modern floor light to be placed next any 1950 modern furniture piece, like your industrial office couch or desk. The 1 light adjustable head floor lamp with matte black and matte white accents has a simplistic and sleek design featuring a black textile cord and an adaptable shade. With a classic shape making it suitable for not only Scandinavian style homes, this brass floor lamp will also fit perfectly in every single home design style.

### MATERIALS

**BODY:** Brass  
**SHADE:** Aluminum  
**WIRE:** Textile

### WEIGHT

Approx.: 5 kg | 11 lbs

### BULBS (40 w)

1 x E27 Bulbs (included)  
(bulbs not included for North America)

### DIMENSIONS

**HEIGHT:** 70.5" | 179 cm  
**DEPTH:** 18" | 45 cm



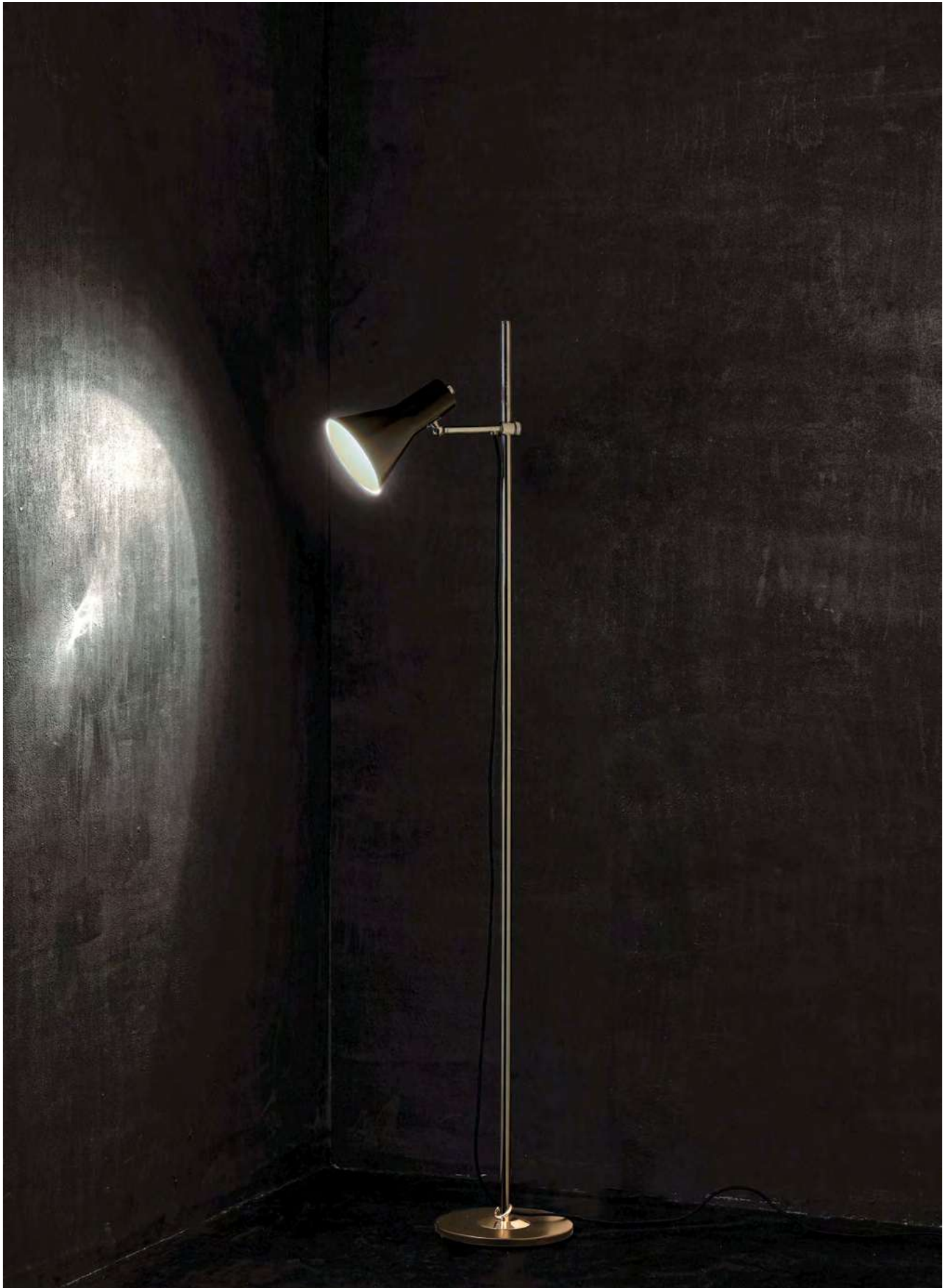

# COLTRANE

## FLOOR LAMP

Inspired by the American jazz saxophonist and composer John Coltrane, Coltrane floor lamp embodies the avant-garde jazzy vibe that this legendary musician transmitted in every music concert.

Handmade in brass and aluminum, the minimal black floor lamp has a matte black finish on the three lamp shades with a gold powder paint on the inside, that provide a smooth lighting effect.

This functional floor lamp is ideal for minimalist settings, as well as for, mid-century modern reading nooks.



### MATERIALS

**BODY:** Brass and Aluminum

**SHADE:** Steel

### WEIGHT

Approx.: 15 kg | 33 lbs

### BULBS (40 w)

6 x Gu10 Bulbs (included)

(bulbs not included for North America)

### DIMENSIONS

**HEIGHT:** 68.9" | 175 cm

**DIAM.:** 11.8" | 30 cm



# DIANA

## FLOOR LAMP

Meet Diana floor lamp, the tallest floor lamp of Heritage collection. Diana is an industrial floor lamp with a mid-century modern design, perfect for big industrial lofts and artistic studios. Built out of steel with a nickel plated finish, this floor light has a giant lamp shade that features a glossy red lacquer on the outside and a matte white interior finishing. However, the colorful aluminum lamp shade can be customized with any RAL color and will point light in every direction you need it, since it has a flexible lamp shade. This floor light is perfect for lighting while reading or working or even for ambient lighting. Going as high as 90.5 inches with a switch on the top, Diana XL floor lamp will turn any room into a giant colorful inviting space. Could it be more unique than this?

### MATERIALS

**BODY:** Steel  
**SHADE:** Aluminum

### WEIGHT

Approx.: 45 kg | 39.7 lbs

### BULBS (40 w)

1 x E27 Bulb (included)  
(bulbs not included for North America)

### DIMENSIONS

**WIDTH:** 51.2" | 130 cm  
**HEIGHT:** 90.5" | 230 cm  
**DEPTH:** 59" | 150 cm







# DUKE

## FLOOR LAMP

Duke Ellington has been an inspiration around the world to many artists and musicians like Dave Brubeck and Miles Davis. Therefore, DelightFULL's designers have decided to pay a tribute to this iconic jazz musician and create Duke floor lamp.

With a short silhouette and a single swing, Duke floor lamp is a retro-styled accessory for every single mid-century modern interior design. Each cone lamp shade is conducted by a brass arm and its counter-weight.

The matte black shades drape on the sides to reveal a white interior and have gold plated accents at the sockets. The three cone shades that adjust vertically and horizontally have an overall height of 63.7 inches.



### MATERIALS

**BODY:** Brass  
**SHADE:** Aluminum and Brass  
**WIRE:** Textile

### WEIGHT

Approx.: 18 kg | 39.68 lbs

### BULBS (40 w)

9x G9 Bulbs (included)  
(bulbs not included for North America)

### DIMENSIONS

**HEIGHT:** 63.7" | 162 cm  
**BASE DIAM.:** 13.8" | 35 cm



# EVANS

## FLOOR LAMP

With a mid-century modern vibe, this Evans floor lamp has three diffusers. Each shade is moveable and adjusts making this a very functional light source that can be changed depending on where it is placed. This tripod floor lamp features an avant-garde design that will provide a light-filled optimism to your mid-century modern interior design. The matte black & gold powder paint finishes are a great accent for any space. With a height of 74 inches, the on/off switch is conveniently located for a quick and easy use.

### MATERIALS

**BODY:** Brass  
**SHADE:** Aluminum  
**WIRE:** Textile

### WEIGHT

Approx.: 8 kg | 17.6 lbs

### BULBS (40 w)

3 x E27 Bulbs (included)  
(bulbs not included for North America)

### DIMENSIONS

**HEIGHT:** 74" | 190 cm  
**DIAM.:** 25.6" | 65 cm





# HANNA

## FLOOR LAMP

Hanna is a vintage floor lamp that will suit perfectly in your mid-century modern living room or vintage retro design hallway.

With a structure made in polished marble estremoza and with multiple lamp shades made in brass and aluminum, this floor light is a pure mid-century modern lamp full of grace and charm. Its flexible lamp shades allow you to spread the light anywhere you want it to be. Bathed in gold plated and matte white finishes, Hanna showcases a high quality craftsmanship, since it was applied an ancient technique called hand metal spinning.

On the whole, this brass floor lamp reports to a classical ambiance, back to art deco, evoking a powerful mid-century modern design.

### MATERIALS

**BODY:** Brass

**SHADE:** Brass and Aluminum

**BASE:** Marble Estremoza (Polished)

### WEIGHT

Approx.: 34 kg | 75 lbs

### BULBS (40 w)

5 x E27 Bulbs (included)

(bulbs not included for North America)

### DIMENSIONS

**HEIGHT:** 66.9" | 170 cm

**MAX DIAM.:** 31.5" | 80 cm





# HERBIE

## FLOOR LAMP

Inspired by the amazing personality of Herbie Hancock, Herbie floor lamp provides a brilliant warm vibe to every mid-century modern room. With a structure handmade in brass, its matte black exterior is complimented by a matte white interior shade. The standing lamp offers the possibility to regulate its direction and height from 47, 24" to 63 inches.

Ideal for a variety of styles and with a minimalist style, this modern light will make a statement next to any mid-century accent chair, chaise or sofa to give your interior design a contemporary style.

### MATERIALS

**BODY:** Brass

**SHADE:** Aluminum

### WEIGHT

Approx.: 6,5 kg | 14.3 lbs

### BULBS (40 w)

1 x E27 Bulbs (included)

(bulbs not included for North America)

### DIMENSIONS

**WIDTH:** 18.8" | 48 cm

**HEIGHT:** 63" | 160 cm

**DEPTH:** 9.8" | 25 cm



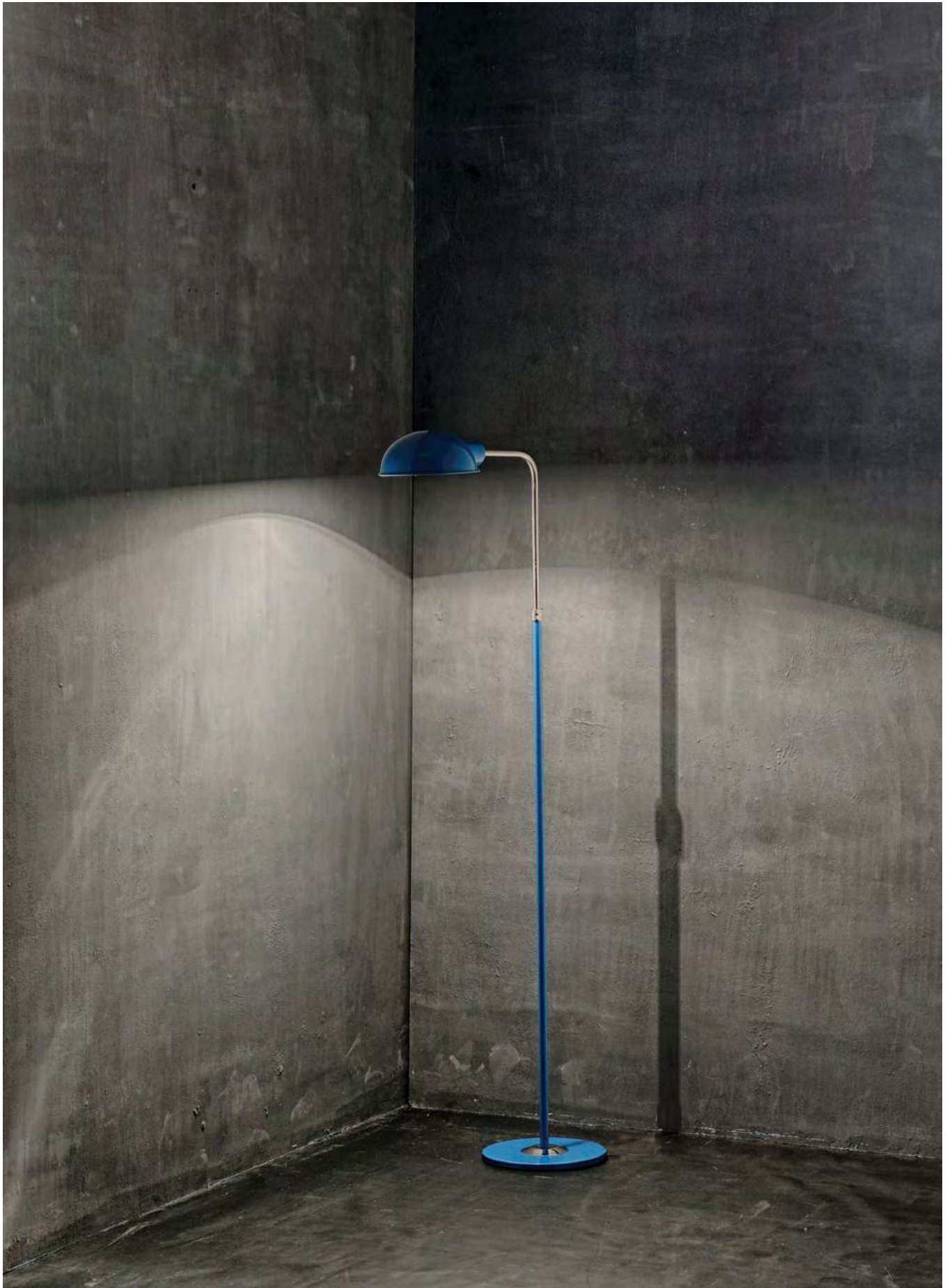



# IKE

## FLOOR LAMP

Strict northern design rules meets a southern taste. Characterized by the rhythmic composition of its elements, minimalist shapes and clean lines, Ike floor lamp is the result of a collaboration between a Dutch designer and DelightFULL's designers team.

Light up your nordic style living room, bedroom or office with this 70" minimalist floor lamp.

With three adjustable lamp shades with glossy black and gold plated finishes, this Scandinavian floor lamp can light multiple areas, making it the perfect addition to your mid-century modern interior.

All in all, Ike is an elegant brass floor lamp full of refinement and modernity, providing a warm and inviting tone to any room.

### MATERIALS

**BODY:** Brass  
**SHADE:** Brass and Aluminum  
**BASE:** Brass and Aluminum

### WEIGHT

Ike 3 - Approx.: 12 kg | 26.4 lbs  
 Ike 10 - Approx.: 22 kg | 49 lbs

### BULBS (40 w)

Ike 3 - 3 x G9 Bulbs (included)  
 Ike 10 - 10 x G9 Bulbs (included)  
 (bulbs not included for North America)

### DIMENSIONS

Ike 3  
**HEIGHT:** 70.8" | 180 cm  
**DIAM.:** 15.7" | 40cm

Ike 10  
**HEIGHT:** 75.6" | 192 cm  
**DIAM.:** 17.3" | 44cm

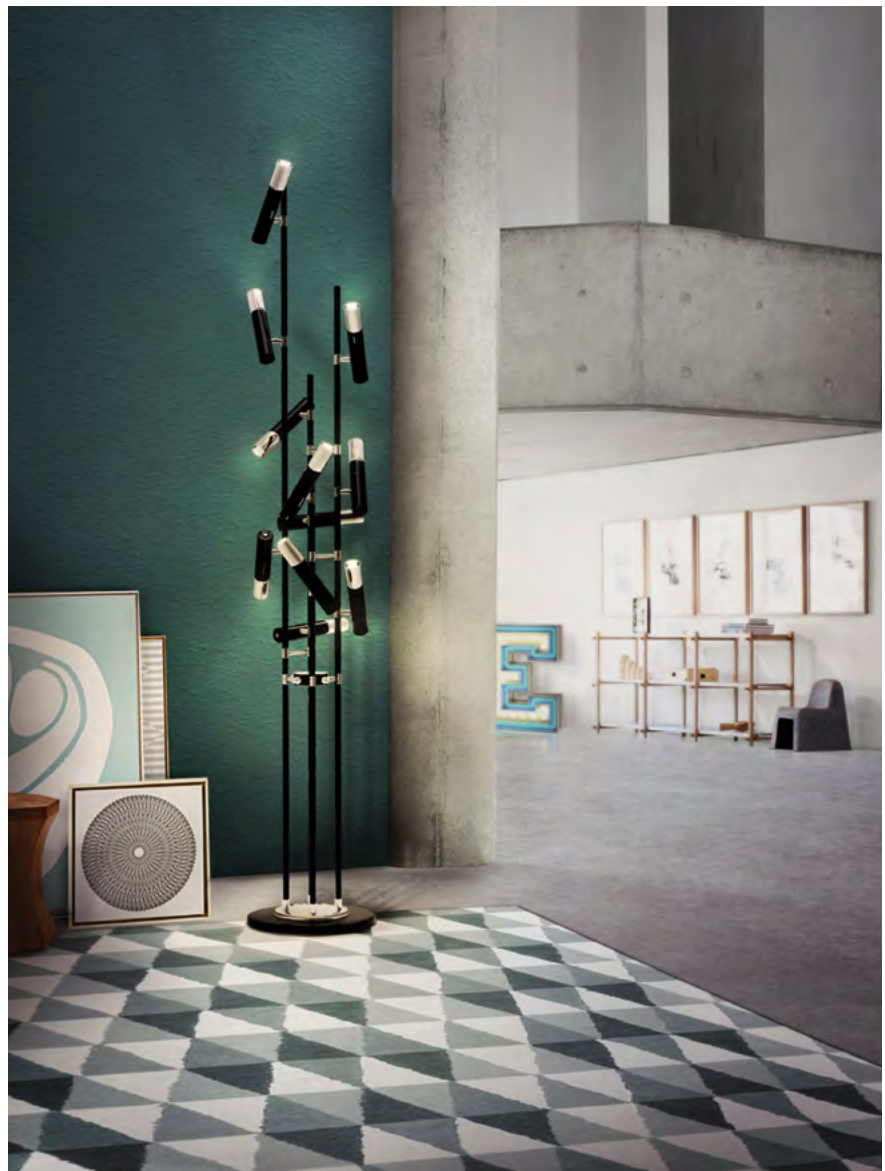



# JACKSON

## FLOOR LAMP

From music to cinema, or even design, Michael Jackson was and still is one of the greatest icons of all times. That's why DelightFULL's designers decided to pay a tribute to this amazing performer, by designing one fabulous piece that embodies rhythm, exposed mechanical elements, and luxurious finishes, never forgetting the inspirations for the 80s. We present you Jackson floor lamp.

This tripod floor lamp is the perfect spin from mid-century design classics to a commemoration of pop culture.

Tailor-made in brass, Jackson floor light features three lamp shades with matte black and gold plated finishes and textile red wires. With adaptable lamp shades, this mid-century floor lamp points light wherever a task light is needed.

### MATERIALS

**BODY:** Brass

**SHADE:** Brass and Aluminum

**WIRE:** Textile

### WEIGHT

Approx.: 12 kg | 26.5 lbs

### BULBS (40 w)

3x Gu10 Bulbs (included)

(bulbs not included for North America)

### DIMENSIONS

**WIDTH:** 31.4" | 80 cm

**HEIGHT:** 70.8" | 180 cm

**DEPTH:** 31.4" | 80 cm





# JANIS

## FLOOR LAMP

Inspired in Janis Joplin's music "Best of The Best Gold", Janis floor lamp recovers the golden jazz spirit of the 60's.

Covered by a golden bath, this entrance floor lamp was designed to make a powerful statement with its mid-century modern design. With almost 67 inches, Janis is 100% handmade in brass, boasting a high quality craftsmanship. This tall standing lamp fits beautifully in a modern entryway or in a classic living room corner, since it is an excellent match for both contemporary and classic decors.

### MATERIALS

**BODY:** Brass

### WEIGHT

Approx.: 25 kg | 55.1 lbs

### BULBS (40 w)

19 x G9 Bulbs (included)  
(bulbs not included for North America)

### DIMENSIONS

**HEIGHT:** 66.9" | 170 cm

**DIAM:** 16.5" | 42 cm

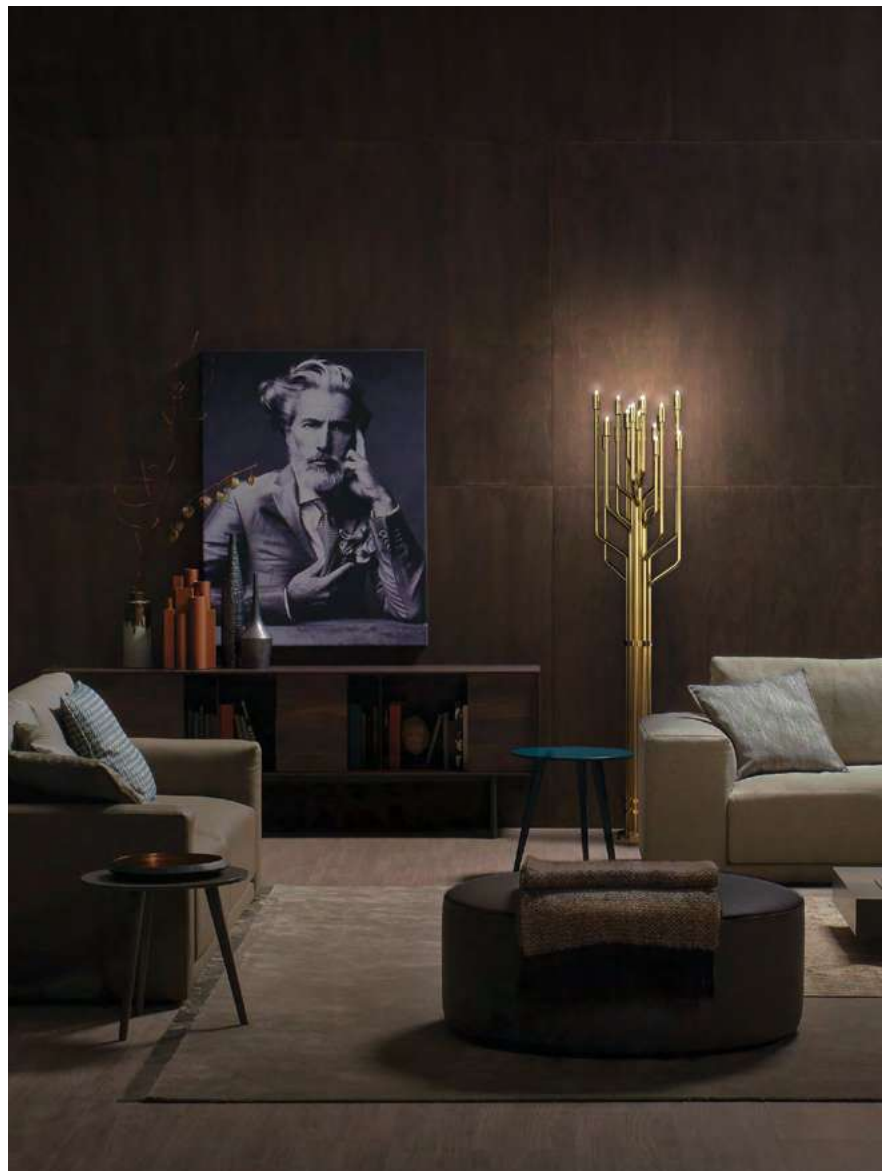



# LEE

## FLOOR LAMP

Mid-century modern design inspired Lee floor light. Inspired by a classic 1950's vintage style microphone on top of a stage, this standing lamp will steal everyone's attention to it.

Ideal for an industrial loft and for a mid-century interior, Lee is the perfect corner lamp for every demanding setting, making an excellent addition to DelightFULL's Heritage collection.

This vintage floor lamp piece is handmade in brass and its lamp shades in aluminum have a glossy black exterior and a matte white interior finishing. The top cover features nickel plated and matte white finishes, with a structure in brass.



### MATERIALS

**BODY:** Brass  
**SHADE:** Aluminum  
**TOP COVER:** Brass

### WEIGHT

Approx.: 10 kg | 22 lbs

### BULBS (40 w)

1x E27 Bulb (included)  
 (bulbs not included for North America)

### DIMENSIONS

**HEIGHT:** 65.4" | 166 cm  
**WIDTH:** 11.8" | 30 cm  
**DEPTH:** 9.8" | 25 cm





# MATHENY

## FLOOR LAMP

Matheny stilnovo floor lamp came to reinvent classic designs with a high aesthetic feeling. Gathering influences from American jazz guitarist Pat Metheny, DelightFULL's designers created a lamp that incorporates elements of progressive, mid-century and contemporary design.

Going as tall as 65 inches, this tall floor lamp is composed of geometric golden tubes that reflects the sophistication of the mid 50s.

With a structure handmade in brass and gold plated and glossy black finishes, this elegant corner lamp provides high quality craftsmanship.

Ideal for a classic living room with a modern design and for hotel projects, place this mid-century floor lamp as a centerpiece of art.

### MATERIALS

**BODY:** Brass

### WEIGHT

Approx.: 40 kg | 88 lbs

### BULBS (40 w)

9 x E27 Bulb (included) (bulbs not included for North America)

### DIMENSIONS

**HEIGHT:** 65" | 165 cm

**DIAM:** 13.8" | 35 cm





# MILES

## FLOOR LAMP

Inspired by the American jazz trumpeter, bandleader, and composer: Miles Davis, DelightFULL has created a mid-century floor lamp that will bring back the sophistication and elegance of the 50's.

The black floor lamp has a vintage style that will provide a more welcoming and refined atmosphere to every single mid century modern bedroom set or living room area. Miles floor lamp is the magnificent combination of a gold plated frame and a black marble portoro base. With a matte black finish and a structure 100% handmade in brass, the vintage floor lamp has a black ornament that provides a balanced design to the modern lighting.

The brass floor lamp casts a smooth light that can be turned on using a gold pendant switch, that will surely make you feel in a "Kind of Blue" mood.

### MATERIALS

**BODY:** Brass

**SHADE:** Aluminum

**BASE:** Marble Portoro (Polished)

### WEIGHT

Approx.: 18.5 kg | 40.8 lbs

### BULBS (40 w)

4 x E27 Bulb (included)

(bulbs not included for North America)

### DIMENSIONS

**HEIGHT:** 69.7" | 177 cm

**DIAM:** 25.6" | 65 cm





# NEIL

## FLOOR LAMP

Neil floor lamp is a reminiscent lamp of the golden years of space. A round, brass base secures a black matte stem reaching up into three glossy black finished lamp shades with a futuristic style.

The three arms with adjustable lights provide a good periferic light range.

The elegance of the continuous flowing center tubes gives a floating sensation to the whole piece, that would be perfect in a retro style living room next to a lounge chair or in a luxurious lobby. The gold plated body is the ultimate detail in this retro floor lamp.

Handmade in brass tubing using a classic method of bending the brass twice into a rounded oblong shape that allow for bright and load casts of light holding spherical diffusers with a retro design.

### MATERIALS

**BODY:** Brass  
**SHADE:** Aluminum  
**WIRE:** Textile

### WEIGHT

Approx.: 20 kg | 44.1 lbs

### BULBS (40 w)

3 x E27 Bulb (included)  
(bulbs not included for North America)

### DIMENSIONS

**HEIGHT:** 69.3" | 176 cm  
**DIAM:** 26" | 65 cm





# PASTORIUS

## FLOOR LAMP

Like the influential Jaco Pastorius jazz composer but also a gifted electric guitar player, Pastorius standing lamp revives the 70's design aesthetics with a dual character. The result is a sophisticated and highly functional brass floor lamp with two distinct diffusers that can be lit alternatively. Therefore, the vintage floor lamp allows you to point the light where you need it the most.

Pastorius is the ideal corner light for your mid-century living room and reading corner, since this adaptable floor lamp can provide to any space the perfect reading lighting. The black and white floor lamp has a structure made in brass and lamp shades in acrylic and aluminum with a matte black and glossy white exterior.

### MATERIALS

**BODY:** Brass

**SHADE:** Aluminum and Acrylic

### WEIGHT

Approx.: 6 kg | 13.2 lbs

### BULBS (40 w)

2 x E27 Bulb (included)

(bulbs not included for North America)

### DIMENSIONS

**HEIGHT:** 70.1" | 178 cm

**WIDTH:** 24.4" | 62 cm

**DEPTH:** 11.8" | 30 cm







# SCOFIELD

## FLOOR LAMP

Scofield is an unusual floor lamp with five chrome lights all supported by a white brass base. Each light and bracket rotate separately allowing different light focuses. The mid-century modern floor lamp has round lamp shades in aluminum, that can support different activities and create an industrial design in the room.

With matte white and a nickel plated finished, the sleek standing lamp can be customized with any RAL color of your choosing, adding a more personalized and welcoming atmosphere to your modern industrial interior design.

Scofield floor lamp can reach 72.1 inches for a more precise lighting control.

### MATERIALS

**BODY:** Brass

**SHADE:** Aluminum and Brass

**WIRE:** Textile

### WEIGHT

Approx.: 12 kg | 26.5 lbs

### BULBS (40 w)

5 x Gu10 Bulbs (included)

(bulbs not included for North America)

### DIMENSIONS

**HEIGHT:** 71.6" | 182 cm

**DIAM.:** 14.1" | 36 cm





# SIMONE

## FLOOR LAMP

Inspired by the one and only Nina Simone, DelightFULL designers have taken a classic lighting design and reinterpreted it into a fresh mid-century floor lamp. Much like Mz.Simone, this unique lamp is a strong statement piece, that cannot go unnoticed wherever it's placed.

Simone is a three-light articulating floor lamp with glossy white shades and a structure handmade in brass. With textile red wires above the large lamp shades, this retro light will create the perfect atmosphere for your mid-century modern home. All in all, Simone standing lamp aims to pass on Simone's powerful personality, as well as her bold and warrior features.



### MATERIALS

**BODY:** Brass  
**SHADE:** Aluminum  
**WIRE:** Textile

### WEIGHT

Approx.: 15 kg | 33 lbs

### BULBS (40 w)

3 x E27 Bulbs (included)  
(bulbs not included for North America)

### DIMENSIONS

**HEIGHT:** 70.9" | 180 cm  
**WIDTH:** 51.2" | 130 cm  
**DEPTH:** 39.4" | 100 cm



# SINATRA

## FLOOR LAMP

If you ever find yourself listening to "New York, New York" by Frank Sinatra while drinking a cocktail in a mid-century bar, this lighting design will be there. Inspired by one of the most popular and influential musical artists of the 20th century, Sinatra standing lamp is the perfect addition to your mid-century home decor. A sculptural and versatile creation, the iconic modern floor lamp features three articulating arms handmade in brass that are adjustable in a variety of different locations in order to allow you to situate the lights exactly as you need it. It has a height of 70.9 inches and sits on a brass base with a counterweight made in steel for a sleek contemporary style. This task floor lamp exudes a mid-century modern flair that will elevate your art deco interior design.

### MATERIALS

**BODY:** Brass  
**SHADE:** Aluminum  
**COUNTER WEIGHT:** Steel

### WEIGHT

Approx.: 12 kg | 26.5 lbs

### BULBS (40 w)

3 x E27 Bulbs (included)  
(bulbs not included for North America)

### DIMENSIONS

**HEIGHT:** 70.9" | 180 cm  
**WIDTH:** 51.2" | 130 cm  
**DEPTH:** 39.4" | 100 cm





# STANLEY

## FLOOR LAMP

Stanley floor light is a style icon of the fifties and sixties. With the possibility of having 1 to 3 moveable arms, this vintage style floor lamp will add effortless style to your mid-century modern reading nook.

The adjustable 3-light floor lamp holds three boom arms, creating custom light effects due to its glossy black & matte white lamp shades. Each shade is balanced by a weighted handle.

With clean lines and a sculptural shape, this gleaming nickel plated lamp will make you want to curl up with a book in your reading chair under the warm glow of your mid-century reading light.

### MATERIALS

**BODY:** Brass

**SHADE:** Aluminum

**COUNTER WEIGHT:** Steel

### WEIGHT

Approx.: 13 kg | 28.6 lbs

### BULBS (40 w)

3 x E27 Bulbs (included)

(bulbs not included for North America)

### DIMENSIONS

**HEIGHT:** 70.9" | 180 cm

**WIDTH:** 51.2" | 130 cm

**DEPTH:** 39.4" | 100 cm







# STARDUST

## FLOOR LAMP

Stardust floor lamp is a mid-century modern revolving lamp that was inspired by the stellar orbits. The main goal of this lighting design is to light up your mid-century modern home just like the constellations do it at night.

Constructed out of brass tubing into a rounded oblong shape, this modern floor lamp will shine brightly due to the light cast by the bulbs arranged in the same way as a candelabra.

Ideal for a mid-century modern dining room and a vintage living room, this gold plated floor lamp will bring an astral beauty to your space.

### MATERIALS

**BODY:** Brass

### WEIGHT

Approx.: 18 kg | 40 lbs

### BULBS (40 w)

7 x E14 Bulbs (included)  
(bulbs not included for North America)

### DIMENSIONS

**HEIGHT:** 66.5" | 169 cm

**DIAM.:** 15.7" | 40 cm

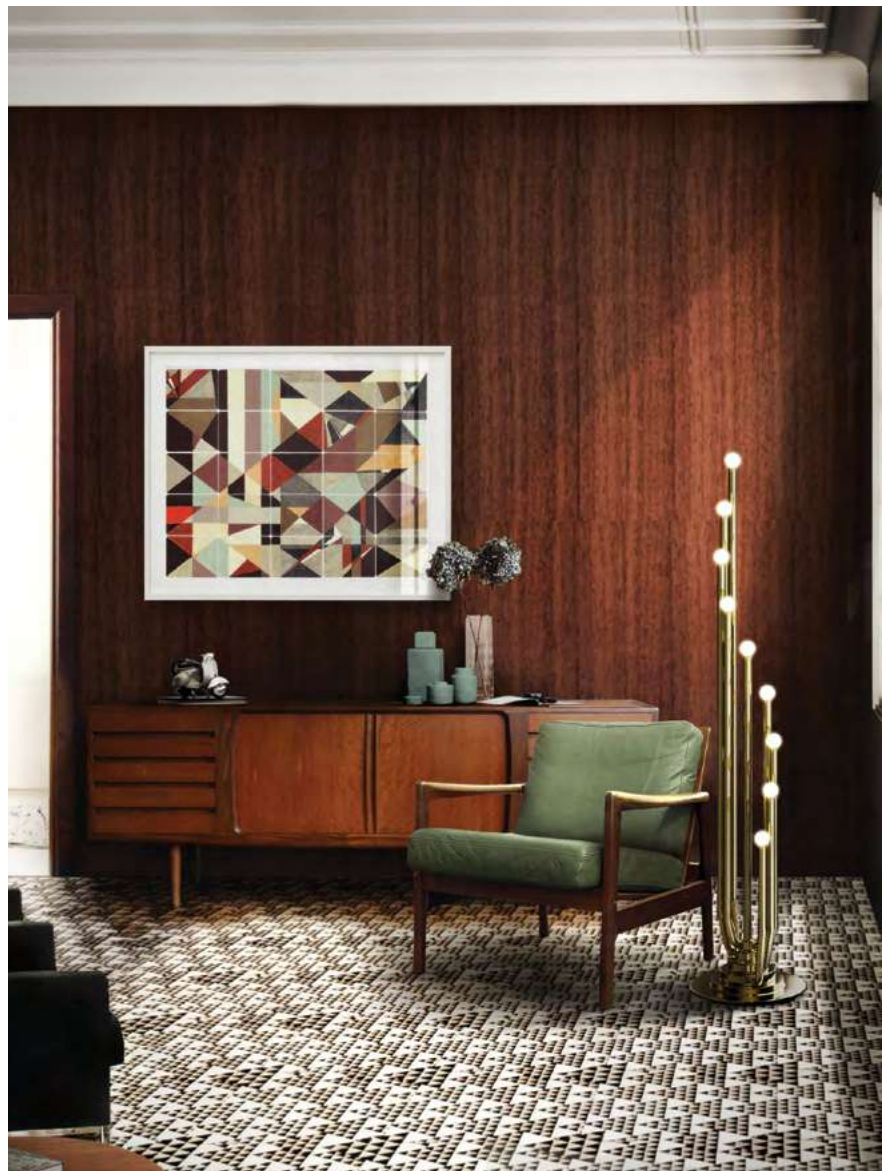



# TORCHIERE

## FLOOR LAMP

Torchiere is probably one of the most functional lamps of DelightFULL. Ideal for your mid-century modern office and reading corner, this floor light will add elegance to every single space.

With Torchiere, your lighting options are truly limitless. This ultimate lighting trend is great for uplighting, downlighting and reading lighting.

A reading lamp with a lovely black finish that brings two great and functional designs together: torchiere and an adjustable two floor lamp.

This modern floor lamp can reach almost 70 inches, making it an effective addition to well-used spaces of either casual or formal style.

### MATERIALS

**BODY:** Brass

**SHADE:** Aluminum

### WEIGHT

Approx.: 17 kg | 37 lbs

### BULBS (40 w)

3 x E27 Bulbs (included)

(bulbs not included for North America)

### DIMENSIONS

**HEIGHT:** 66.9" | 170 cm

**DIAM.:** 55.1" | 140 cm

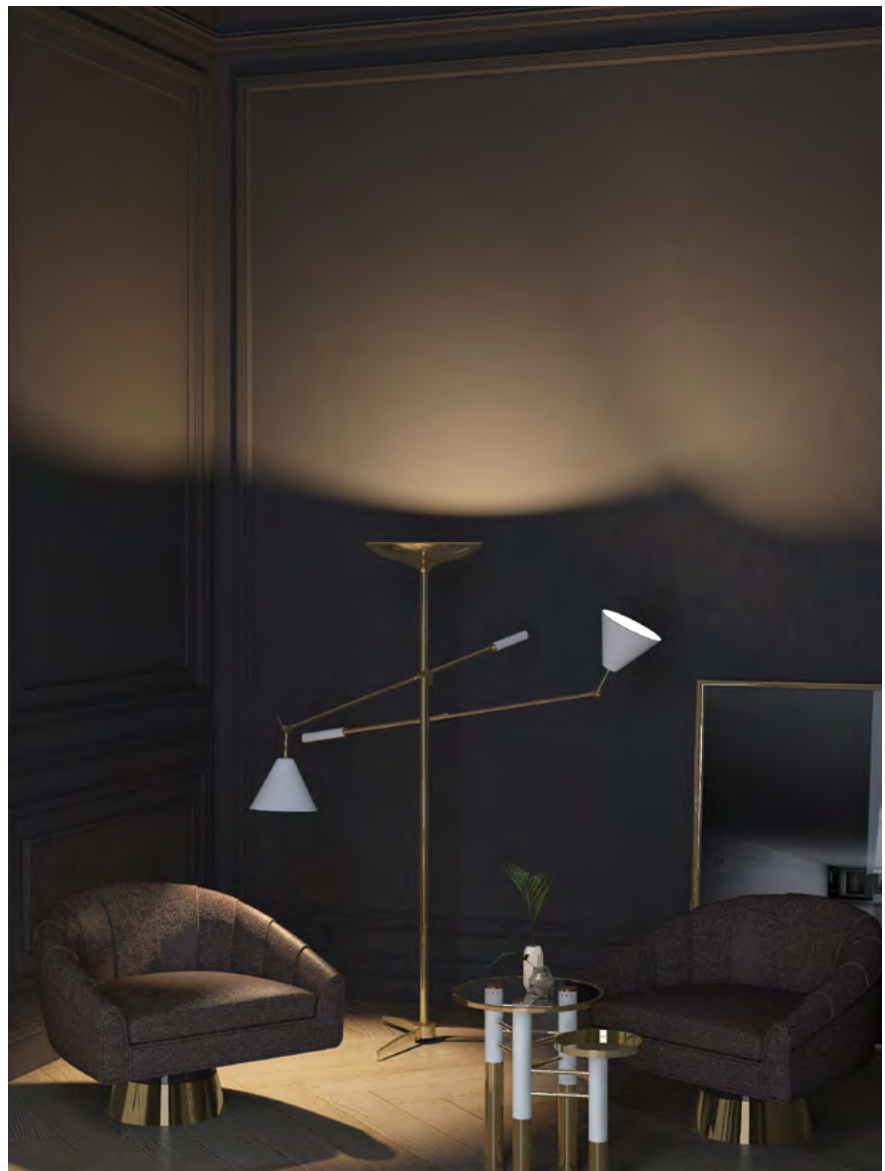



# TURNER

## FLOOR LAMP

Turner floor lamp was inspired by Tina Turner's electrifying dance moves. Ideal for any hotel design project, this art deco floor lamp will fit perfectly in a modern lobby entrance or next to a mid-century lounge chair. This mid-century floor lamp has five large arcs made in brass and a semi-spherical top cover of aluminum lacquered in glossy white or any other RAL color of your choosing. With the possibility of rotating its arcs into the desired position, Turner floor light is perfect for anyone looking for a practical lighting design with a cutting edge design. All in all, this modern corner lamp allows you to create your favorite composition at any time, elevating your mid-century modern decor.

### MATERIALS

**BODY:** Brass  
**SHADE:** Aluminum

### WEIGHT

Approx.: 23 kg | 50 lbs

### BULBS (40 w)

4 x G9 Bulbs (included)  
(bulbs not included for North America)

### DIMENSIONS

**HEIGHT:** 66.9" | 170 cm  
**DIAM.:** 19.7" | 50 cm







# TABLE





# AMY

## TABLE LAMP

Amy vintage table lamp is a lighting design inspired by one of the greatest British singers and songwriters of all times. With a glossy black lampshade that resembles her iconic hair and a small brass detail that reminds us of her golden earring, DelightFULL was able to create an unforgettable reading light perfect for any music aficionado. 100% handmade in Portugal, with a gold-plated finish and a glossy black coat applied to the body, this small brass lamp is perfect for a vintage bedroom, or a retro home office.

### MATERIALS

**BODY:** Brass  
**SHADE:** Aluminum

### WEIGHT

Approx.: 2.5 kg | 5.5 lbs

### BULBS (40 w)

2 x E14 (included) (bulbs not included for North America)

### DIMENSIONS

**WIDTH:** 7.8" | 20 cm

**HEIGHT:** 21.6" | 55 cm

**DEPTH:** 11.8" | 30 cm





# ATOMIC

## TABLE LAMP

A modern interpretation of the atomic age, Atomic mid-century desk lamp was inspired by the molecular composition of the atom. With a body handmade in brass and steel, this large table lamp features a set of 4 round spotlights all arranged in an abstract organic composition. Weighing in at almost 20 pounds, Atomic table light has several gold-plated elements that turn it into a sophisticated option perfect for a modern home office, or a contemporary living room.

### MATERIALS

**BODY:** Brass and Steel

**SHADE:** Steel

### WEIGHT

Approx.: 9 kg | 20 lbs

### BULBS (40 w)

4 x G9 Bulbs (included)

(bulbs not included for North America)

### DIMENSIONS

**HEIGHT:** 22.2" | 56.5 cm

**WIDTH:** 17.5" | 44.5 cm

**DEPTH:** 17.5" | 44.5 cm



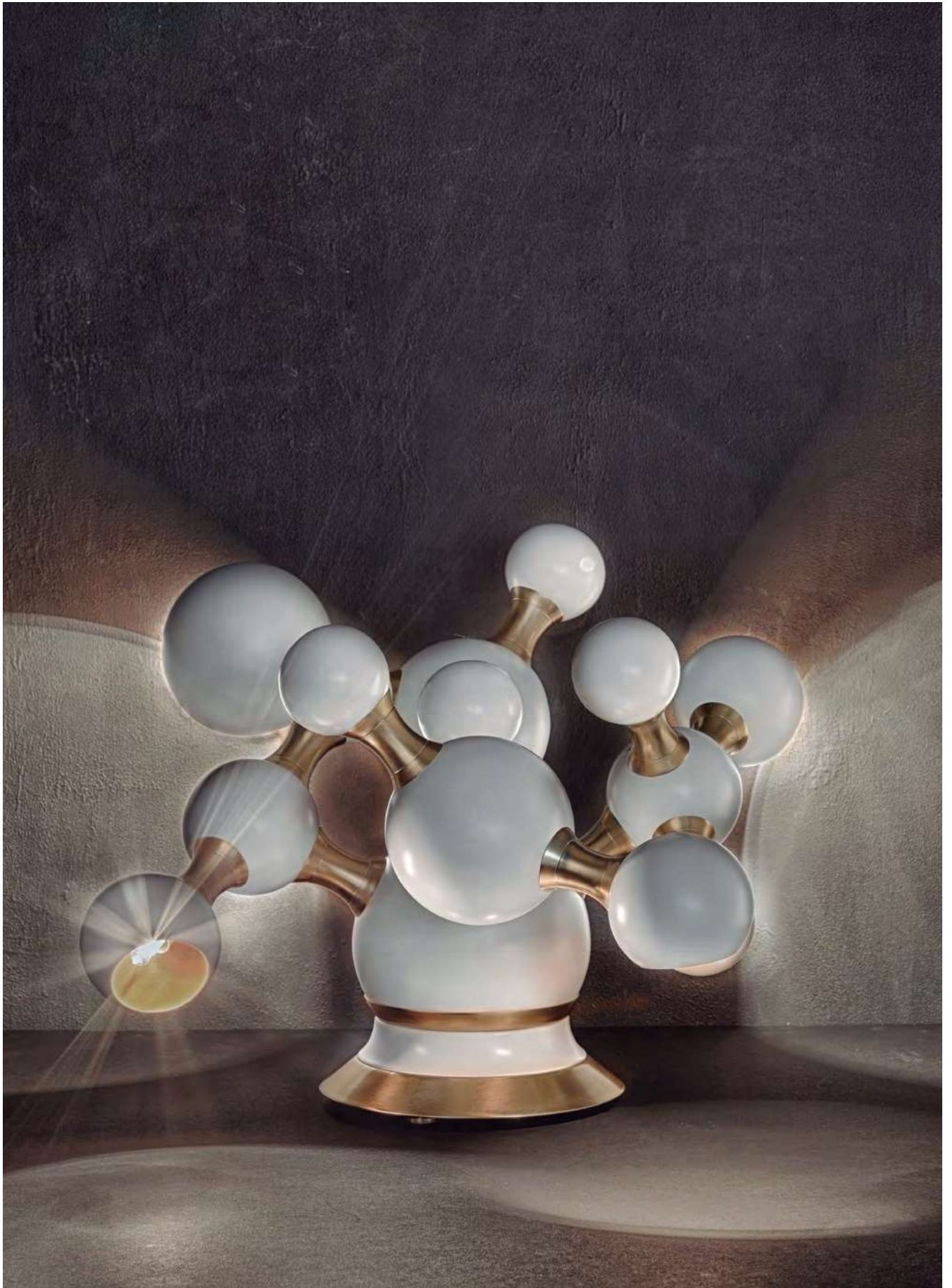

# BARRY

## TABLE LAMP

Representing everything that a tripod table lamp should be, Barry mid-century desk lamp is a handmade piece produced in Portugal by some of the finest artisans in the business. This brass lighting design features a shade and a top cover made in aluminum, top coated in matte black and matte white, which can be customized. The shade has a nickel plated finish, emphasizing the contemporaneity of this fine bedroom table lamp. Going as high as 13', this is fantastic task and reading light for bed.



### MATERIALS

**BODY:** Brass

**SHADE:** Aluminum

**TOP COVER:** Aluminum

### WEIGHT

Approx.: 1.5 kg | 3.3 lbs

### BULBS (40 w)

1 x E14 Bulb (included)

(bulbs not included for North America)

### DIMENSIONS

**WIDTH:** 12.2" | 31 cm

**HEIGHT:** 12.6" | 32 cm

**DEPTH:** 13.4" | 34 cm



# BASIE

## TABLE LAMP

Basie table light is a vintage mid-century lamp with distinct features that make it stand out in any room setting. Handmade in brass, with an aluminum shade and a marble base, it features a top cover that can be customized with any RAL color of your choosing. Looking its best in more formal settings, this graciously large table lamp is the perfect fit for a classic living room or entryway.

### MATERIALS

**BODY:** Brass  
**SHADE:** Aluminum  
**BASE:** Marble

### WEIGHT

Approx.: 12 kg | 26.5 lbs

### BULBS (40 w)

2 x G9 Bulb (included)  
(bulbs not included for North America)

### DIMENSIONS

**WIDTH:** 19.2" | 49 cm  
**HEIGHT:** 19.6" | 50 cm  
**DEPTH:** 16.1" | 41 cm

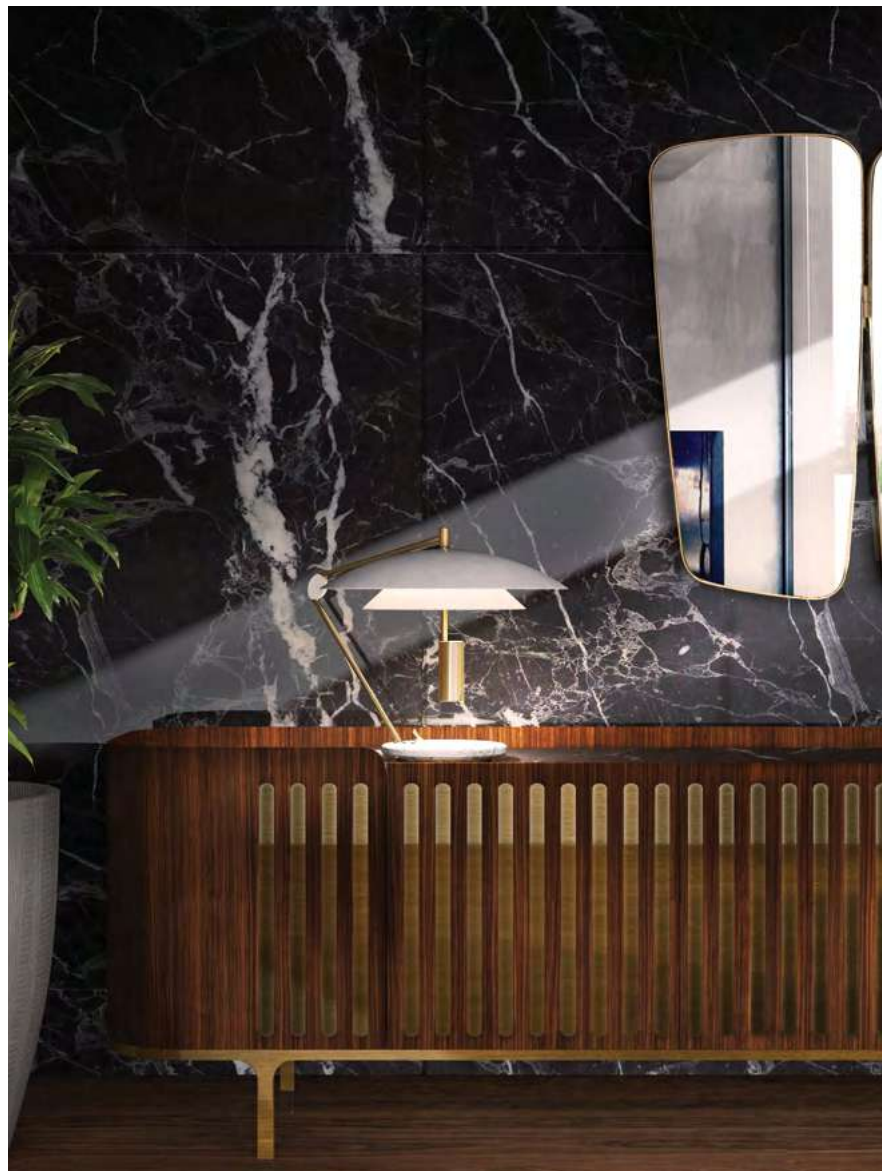





# BILLY

## TABLE LAMP

Billy is a mid-century modern table lamp with all the sophistication of an iconic lighting design. This task lamp is one of DelightFULL's most versatile pieces. With an extendable arm it can reach almost 24", making it the perfect reading lamp, very easy to adjust. Its body and shade are handmade in brass and aluminum. The black table lamp also features a gold-plated finish and a black textile wire, which can all be customized to fit your decor needs. The perfect study table lamp, this is definitely the lighting fixture you will want in your modern home office.

### MATERIALS

**BODY:** Brass  
**SHADE:** Aluminum and Brass  
**WIRE:** Textile

### WEIGHT

Approx.: 5.7 kg | 12.5 lbs

### BULBS (40 w)

2 x G9 Bulb (included)  
 (bulbs not included for North America)

### DIMENSIONS

**HEIGHT:** Min. 15.8" | 40 cm Max. 23.6" | 60 cm  
**WIDTH:** 9.8" | 25 cm  
**DEPTH:** 7.9" | 20 cm

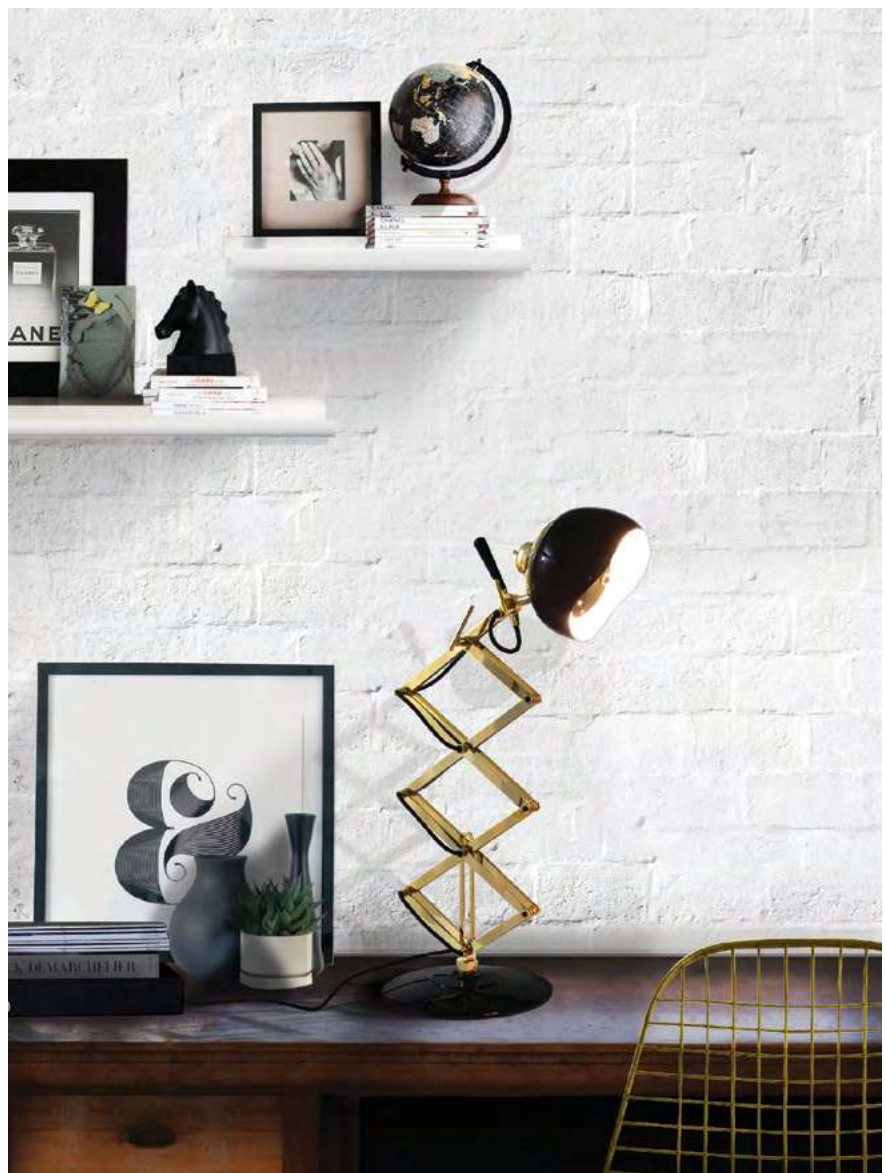



# BOTTI

## TABLE LAMP

The embodiment of the most famous wind instrument of them all, Botti mid-century table lamp was inspired by a classic trumpet. Its unique shades are handmade in brass with a gold-plated finish to resemble a real trumpet. The base can be produced in Nero Marquina or white marble, as well as black nickel or any other finish of your choosing. It is a tall table lamp, very hard to miss, with almost 55 pounds, making it the ideal choice for a classic living room design. This vintage brass table lamp will definitely make a statement in your luxurious home.

### MATERIALS

**BODY:** Nero Marquina and Brass

**SHADE:** Brass

### WEIGHT

Approx.: 25 kg | 55 lbs

### BULBS (40 w)

11 x E14 Silver Crown Bulbs (included)  
(bulbs not included for North America)

### DIMENSIONS

**HEIGHT:** 27.6" | 67.5 cm

**DIAMETER:** 16.5" | 42 cm





# COLTRANE

## TABLE LAMP

The mid-century Coltrane table light is a modern lighting fixture, which embodies the contemporary principles of minimalism. With this in mind, DelightFULL's designers came up with a minimal black table lamp with three tubes that cast the most soothing glaze. This modern desk lamp is handmade in brass and steel, with a gold-plated base that is topped up with a matte black finish on the three shades. It serves as a great bedside table lamp, as well as a unique entryway table light.

### MATERIALS

**BODY:** Steel

**SHADE:** Brass

### WEIGHT

Approx.: 5 kg | 6.6 lbs

### BULBS (40 w)

3 x E14 Silver Crown Bulbs (included)  
(bulbs not included for North America)

### DIMENSIONS

**HEIGHT:** 24.4" | 62 cm

**DIAMETER:** 7.5" | 19 cm





# DIANA

## TABLE LAMP

Diana is a vintage table lamp inspired by some of the greatest design classics of the mid-century era. It is a handmade lamp built with materials such as brass and aluminum. Brass was used on the body, whilst aluminum was chosen for the shade. The aluminum shade is lacquered a glossy red on the outside and matte white on the inside, while for the body a nickel-plated finish was chosen. However, both these colors and finishes can be customized according to your needs. This small lamp is easily the perfect reading light, having a movable and adjustable shade, that casts light to where it is needed. It best fits more minimalist or industrial environments. The perfect study table lamp.

### MATERIALS

**BODY:** Brass  
**SHADE:** Aluminum

### WEIGHT

Approx.: 1.5 kg | 3.3 lbs

### BULBS (40 w)

1 x E27 Bulb (included)  
(bulbs not included for North America)

### DIMENSIONS

**WIDTH:** 13.4" | 34 cm  
**HEIGHT:** 16.9" | 43 cm  
**LENGTH:** 11" | 28 cm

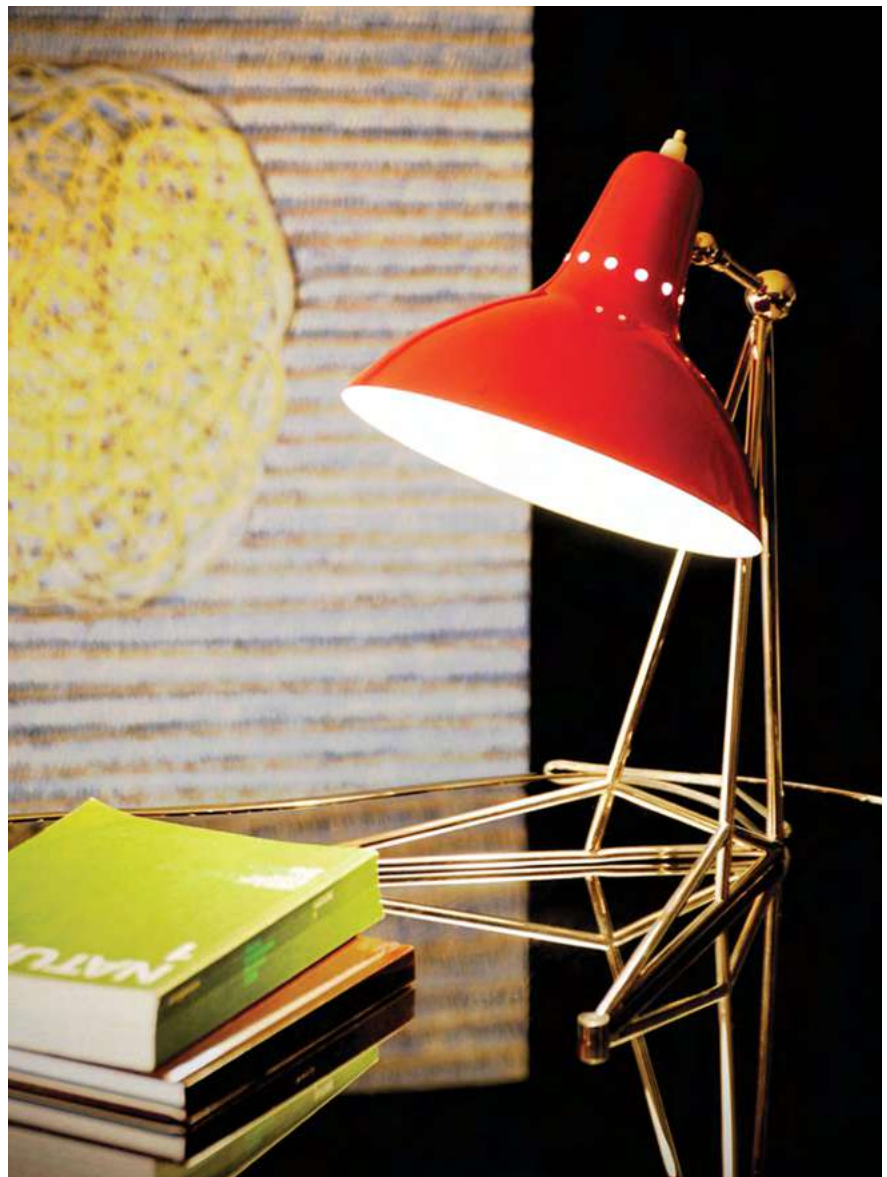





# DONNA

## TABLE LAMP

A majestic tall table lamp, Donna has come to redefine everything we have ever seen in the lighting design world. Almost 28 inches high, this brass desk lamp is much more than that. Handmade in brass and Estremoz marble, both the body and the shade received a gold-plated finish in order to emphasize its luxurious characteristics. Probably DelightFULL's most exclusive design, this gold desk lamp features elegant handmade details all around the shade, giving it a Hollywood glamorous feeling. With an exquisite design, it suits any classic entryway or dining room. It is also the perfect table lamp for living room environments.

### MATERIALS

**BODY:** Brass and Estremoz Marble

**SHADE:** Brass

### WEIGHT

Approx.: 20 kg | 44 lbs

### BULBS (40 w)

6 x G9 Bulbs (included)

(bulbs not included for North America)

### DIMENSIONS

**HEIGHT:** 27.6" | 70 cm

**DIAM.:** 9.8" | 25 cm





# JANIS

## TABLE LAMP

Sophisticated like a Mercedes-Benz, Janis is a mid-century modern table lamp inspired by one of the greatest female rock stars of the 20th century. Almost 28 inches-high, this sleek tall table lamp is a contemporary reinterpretation of the best mid-century lighting design classics. 100% handmade in brass by some of the finest artisans in Portugal, Janis has a gold-plated finish that comes to enhance its luxurious features. An unforgettable brass lighting design that sits well in a classic living room, or a modern entryway. This gold desk lamp could also make a statement in your new home office.

### MATERIALS

**BODY:** Brass

### WEIGHT

Approx.: 11 kg | 24.3 lbs

### BULBS (40 w)

12 x G9 Bulbs (included)  
(bulbs not included for North America)

### DIMENSIONS

**WIDTH:** 9" | 23 cm

**HEIGHT:** 27.5" | 70 cm

**DEPTH:** 9" | 23 cm





# KENNY

## TABLE LAMP

Just like the smooth, fluid movements that Kenny Clarke brought every time he found himself in his drum, this modern, timeless design is the one to bring the freedom and unrestraint design that only an icon of the jazz music could. The artisans of DelightFULL had the maximum care to incorporate the rhythm and emotion that only a drummer like Kenny Clarke could bring. A modern lighting design with nero marquina marble structure, the gold-plated body and the small intricate details in the lampshades only bring a grand gesture of glamour and decisiveness. Perfect for a modern home design or to be a part of a hotel lobby.



### MATERIALS

**BODY:** Marble

**BASE:** Brass

### DIMENSIONS

**WIDTH:** 11.42" | 29 cm

**HEIGHT:** 22.05" | 56 cm



# MARCUS

## TABLE LAMP

Marcus table lamp was inspired by Dieter Rams strict design philosophy and timeless aesthetic. This contemporary black table lamp is one of DelightFULL's most versatile pieces. With only 11 inches, it is handmade in brass, aluminum, steel and acrylic, which are all combined to make the best lighting design. The body features a nickel plated finish, while the base and the shade are built in aluminum and lacquered a matte black to create a more neutral expression and showcase the versatility of the small table lamp. With its minimalist vibe, it could definitely be used as a nightstand lamp in a Scandinavian bedroom. It is also a great modern desk lamp that would look incredible in a more contemporary home office.

### MATERIALS

**BODY:** Brass

**SHADE:** Aluminum and Steel

### WEIGHT

Approx.: 3.5 kg | 7.7 lbs

### BULBS (40 w)

1x E27 Bulb (included)

(bulbs not included for North America)

### DIMENSIONS

**WIDTH:** 11.8" | 30 cm

**HEIGHT:** 13.8" | 35 cm

**DEPTH:** 7.5" | 19 cm







# MATHENY

## TABLE LAMP

Matheny table lamp is a sleek and classic lighting design. 100% designed and produced in Portugal, this tall table lamp goes as high as 24 inches and it is handmade in brass and marble. Its marble base can be customized with four different types of marble to match the gold-plated finish of the body. A unique vintage brass table lamp, Matheny is a new take on the mid-century classics. It is the right table lamp for living room ambiences, but it can also be thought of as a bedside table lamp, depending on the decor of your master bedroom.

### MATERIALS

**BODY:** Brass  
**BASE:** Marble

### WEIGHT

Approx.: 11 kg | 24.3 lbs

### BULBS (40 w)

3 x G9 Bulbs (included)  
(bulbs not included for North America)

### DIMENSIONS

**WIDTH:** 7.4" | 19 cm  
**HEIGHT:** 22.8" | 58 cm  
**DEPTH:** 7.4" | 19 cm

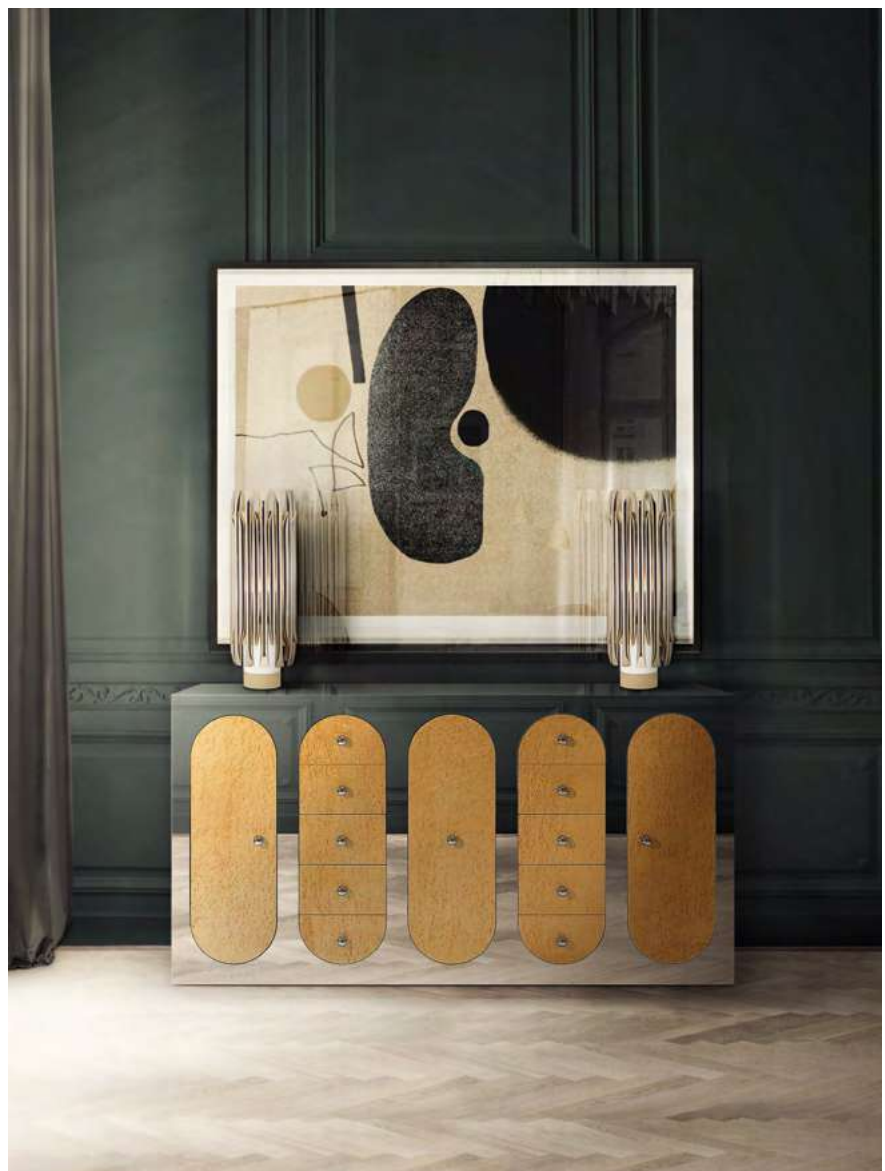



# MEOLA

## TABLE LAMP

With a discrete size, Meola table lamp is a design by DelightFULL that successfully showcases the merge between mid-century design and the contemporary influences of today's world. It boasts a stunning brass body with a nickel plated finish, and an aluminum-built shade lacquered a glossy black on the outside and a matte white on the inside, so as to not reflect the light in an uncomfortable way. This small table lamp has the minimalist vibe we all look for these days. It works beautifully as a bedroom table lamp, especially when used as a reading light for bed. An easy way to bring style into your master bedroom.

### MATERIALS

**BODY:** Brass

**SHADE:** Aluminum

### WEIGHT

Approx.: 3 kg | 6.6 lbs

### BULBS (40 w)

1 x E14 Bulb (included)

(bulbs not included for North America)

### DIMENSIONS

**HEIGHT:** 11" | 28 cm

**DIAM.:** 9.8" | 25 cm





# MILES

## TABLE LAMP

Miles table lamp is a classic mid-century modern table lamp, which brings back the sophisticated atmosphere of the 50s. It is handmade in brass, with an aluminum shade. The body has a copper plated finish for a more contemporary look, while the shade is lacquered a matte black on the outside and a white matte on the inside. It is essentially a copper table lamp that casts a soft glaze that will suit your modern entryway in the most flattering way. It also looks stunning when put on display as an office lamp, so don't be afraid to try and use it as a sophisticated study table lamp.

### MATERIALS

**BODY:** Brass

**SHADE:** Aluminum

### WEIGHT

Approx.: 4 kg | 8.8 lbs

### BULBS (40 w)

3 x E27 Bulbs (included)

(bulbs not included for North America)

### DIMENSIONS

**HEIGHT:** 18.1" | 46 cm

**DIAM.:** 13.4" | 34 cm





# TURNER

## TABLE LAMP

Turner art deco table lamp was inspired by the electrifying and memorable dance moves of the iconic pop singer. Turner is a large table lamp handmade in brass and aluminum. The body has a gold plated finish, while the shade was lacquered a black matte on the outside and a gold powder paint on the inside, so as not to create an uncomfortable glare for the user. Its five movable arcs can be rotated into the desired position, which gives this black table lamp a sense of fun, and allows you to create the best composition to fit your modern home decor. A versatile piece, that can be used in almost any room of your house, this brass desk lamp looks its best when placed in a modern home office or art deco inspired living room.

### MATERIALS

**BODY:** Brass

**SHADE:** Aluminum

### WEIGHT

Approx.: 7.5 kg | 16.5 lbs

### BULBS (40 w)

3 x G9 Bulbs (included)

(bulbs not included for North America)

### DIMENSIONS

**HEIGHT:** 23.6" | 60 cm

**DIAM.:** 11.8" | 34 cm









WALL



# ATOMIC

## WALL LAMP

Atomic wall light is a mid-century modern lighting design inspired by the atomic discoveries of the mid-20th century. With multiple round shades that resemble the molecular composition of the atom, this interior wall light can give a fun twist to a contemporary home decor. Its body is handmade in brass and steel, with both a glossy black and a gold-plated finish. The lamp shades feature a glossy black lacquer on the exterior, while gold powder paint is used for the interior shade. It is with a modern vibe that this indoor wall light creates a statement of mid-century modern design in a contemporary living room, displaying each detail as a faithful reproduction of the glamorous 1950s.

### MATERIALS

**BODY:** Brass and Steel  
**SHADE:** Steel

### WEIGHT

Approx.: 4.3 kg | 9.5 lbs

### BULBS (40 w)

7 x G9 Bulbs (included)  
(bulbs not included for North America)

### DIMENSIONS

**HEIGHT:** 20" | 51 cm  
**WIDTH:** 18.7" | 47.5 cm  
**DEPTH:** 12.6" | 32 cm

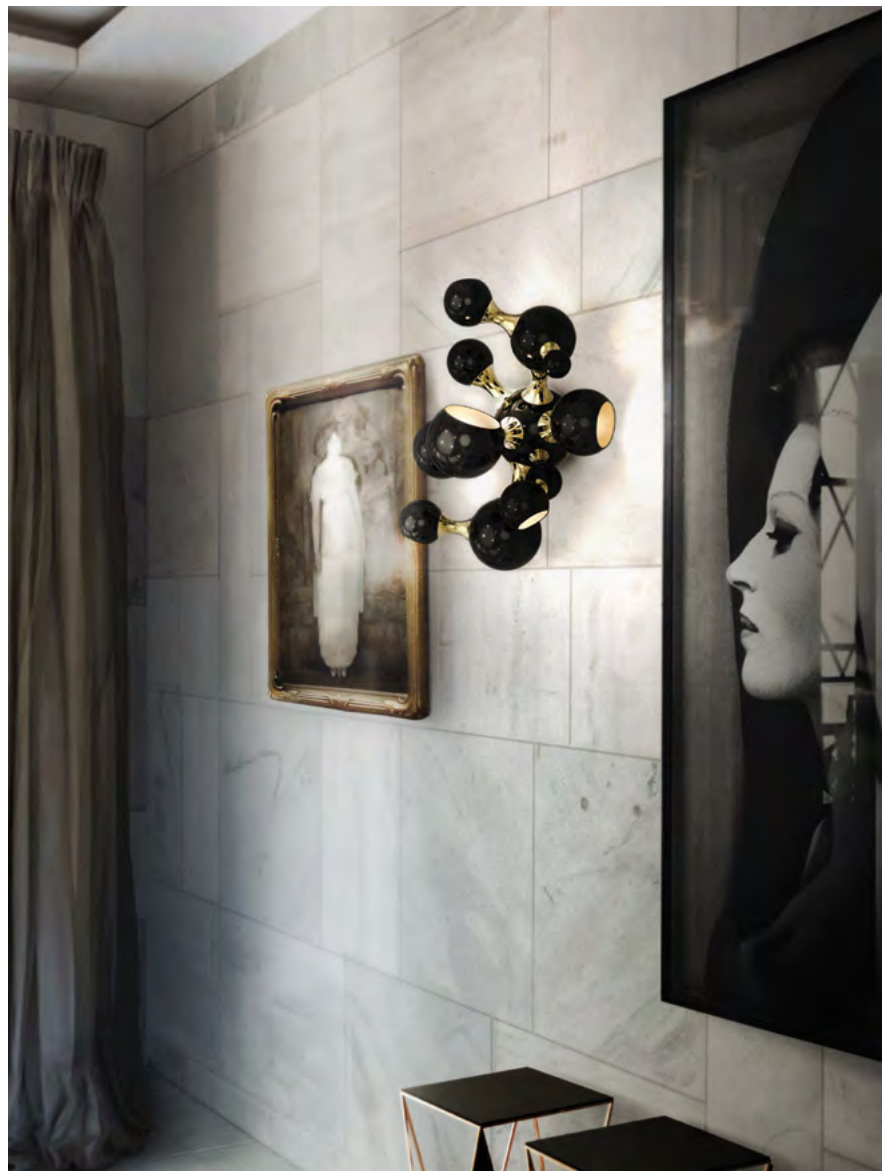



# BASIE

## WALL LAMP

Basie wall light fixture is a modern representation of the sci-fi aesthetics of the 1960s. The vintage mid-century lamp has a set of distinctive features which make it a stunning statement piece. It is an indoor wall light handmade in brass, with a center shade made in aluminum and a mesmerizing gold-plated standard finish. The lamp shade is lacquered a glossy white for a more modern look. Being the sleek and sophisticated piece that is is, it works beautifully as a decorative wall light in any contemporary entryway or living room.

### MATERIALS

**BODY:** Brass  
**SHADE:** Aluminum

### WEIGHT

Approx.: 8 kg | 17.6 lbs

### BULBS (40 w)

3 x G9 Bulbs (included)  
(bulbs not included for North America)

### DIMENSIONS

**HEIGHT:** 18.1" | 46 cm  
**WIDTH:** 12.2" | 31 cm  
**DEPTH:** 16.1" | 41 cm

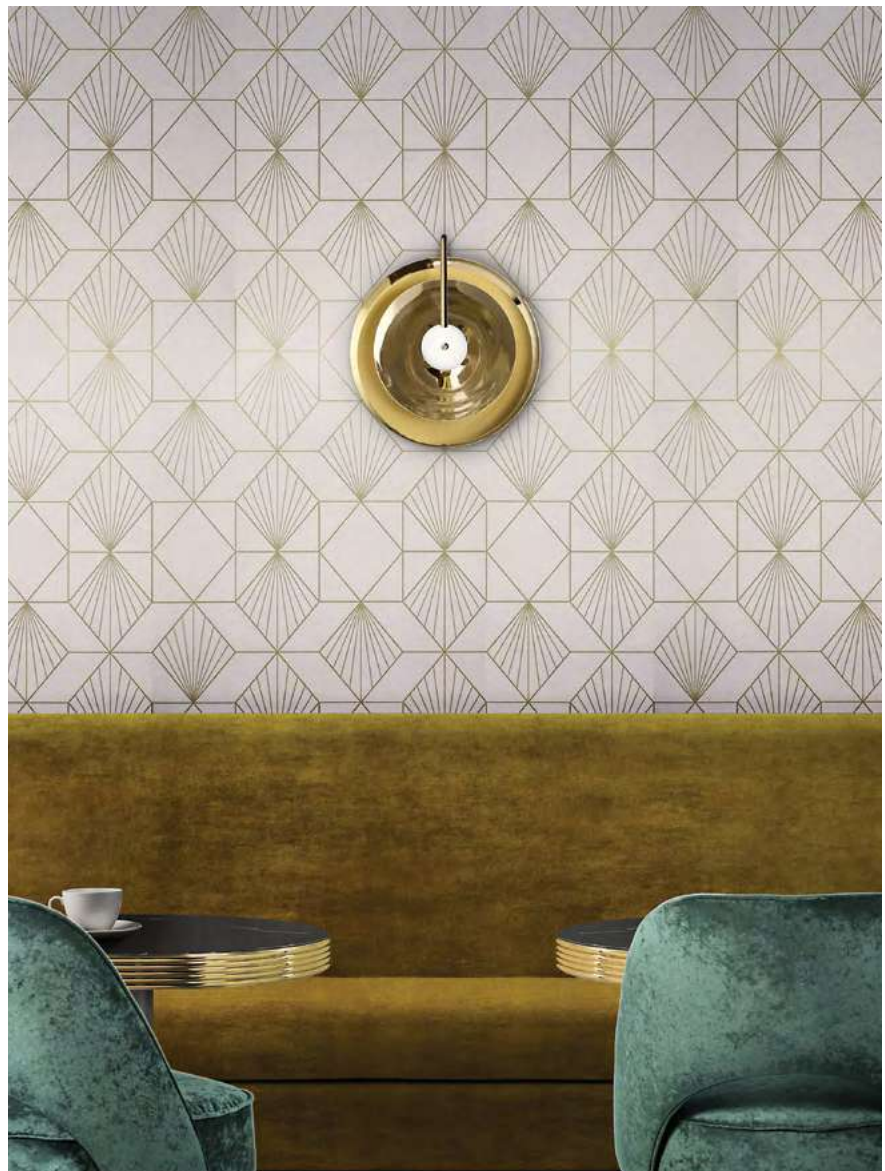



# BRUBECK

## WALL LAMP

Luxury and art deco are synonym with this Brubeck wall sconce lighting design. Inspired by the timeless musical instrument that is the pipe organ and one of the foremost exponents of jazz, Dave Brubeck, this luxurious wall sconce is a statement piece on its own. With 13 pounds, Brubeck is composed by a series of handmade brass tubes that are all welded together by hand. For a finishing touch, it boasts a very art deco gold-plated finish. Only 4 G9 bulbs are needed for this modern wall sconce to light up your home, making it the perfect candidate for a maximalist dining room, or even an entryway decor project.

### MATERIALS

**BODY:** Brass

### WEIGHT

Approx.: 3 kg | 13.2 lbs

### BULBS (40 w)

4 x G9 Bulbs (included)  
(bulbs not included for North America)

### DIMENSIONS

**HEIGHT:** 5.9" | 15 cm

**WIDTH:** 19.7" | 50 cm

**DEPTH:** 4.3" | 11 cm

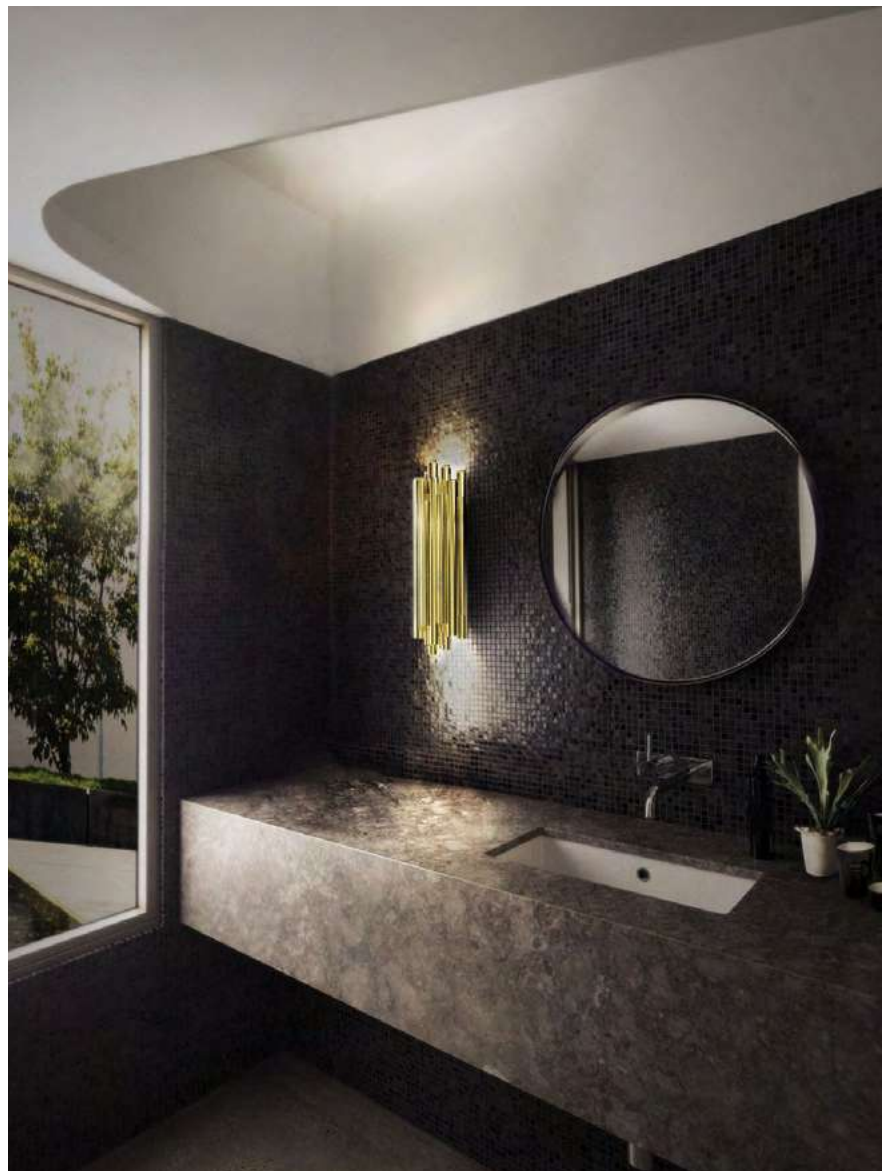

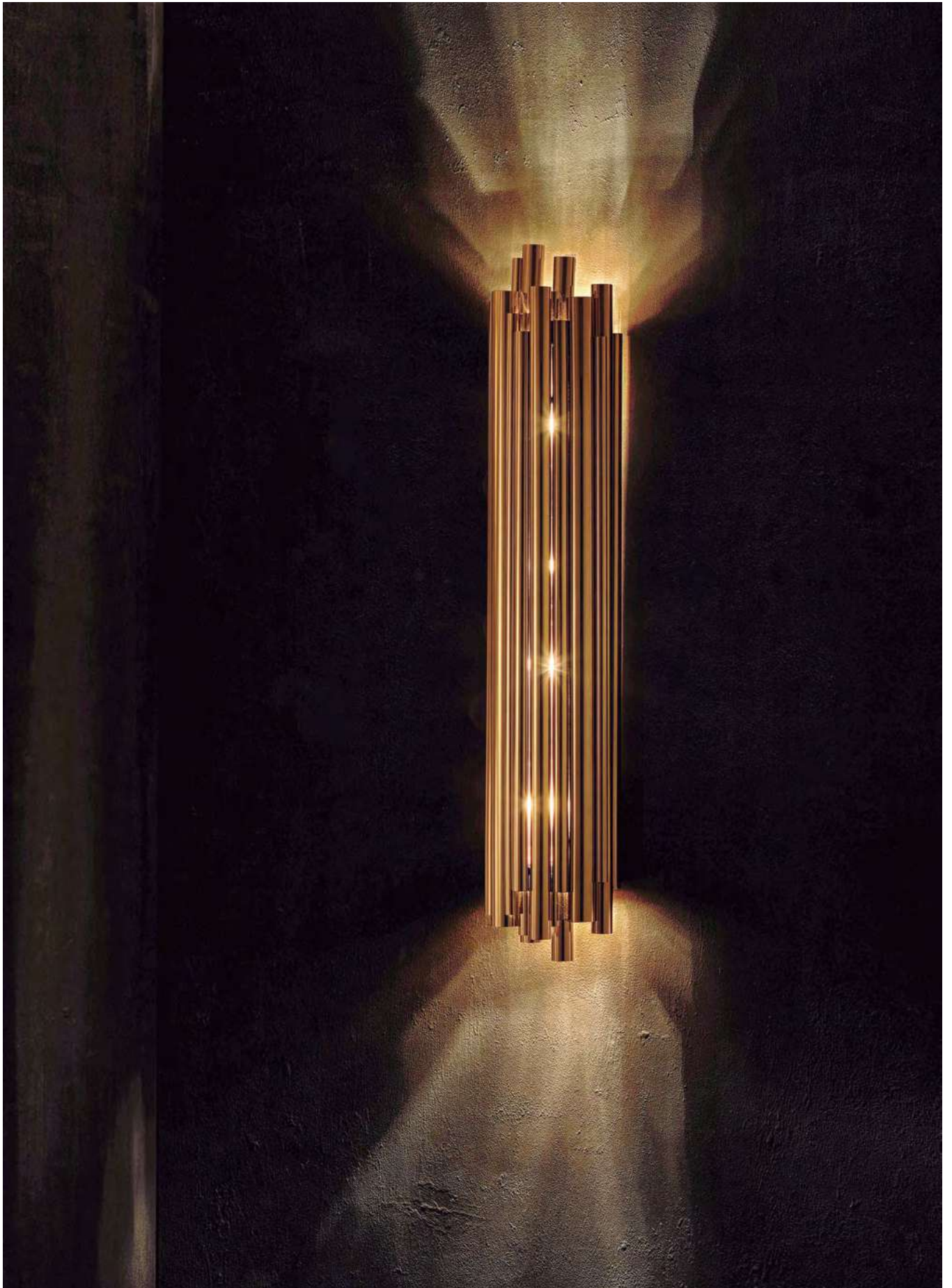



# CHARLES

## WALL LAMP

Charles is a modern vanity light designed by DelightFULL and inspired by the mid-century lighting classics. A simple lighting design, Charles is handmade in brass and aluminum by some of the finest artisans in Portugal. The mount is made of brass, with a nickel plated finish, while the shades have minimalist perforation details and also feature a nickel plated and a matte white finish. It is a mid-century wall sconce that creates a stunning visual effect, having the possibility of being used with one or two diffusers. The perfect wall lamp shade for a Scandinavian style bedroom, or a contemporary bathroom.

### MATERIALS

**BODY:** Brass  
**SHADE:** Brass

### WEIGHT

Approx.: 1 kg | 2.2 lbs

### BULBS (40 w)

1 x E27 Bulb (included)  
(bulbs not included for North America)

### DIMENSIONS

**HEIGHT:** 10.2" | 26 cm

**WIDTH:** 5.9" | 15 cm

**DEPTH:** 6.3" | 16 cm



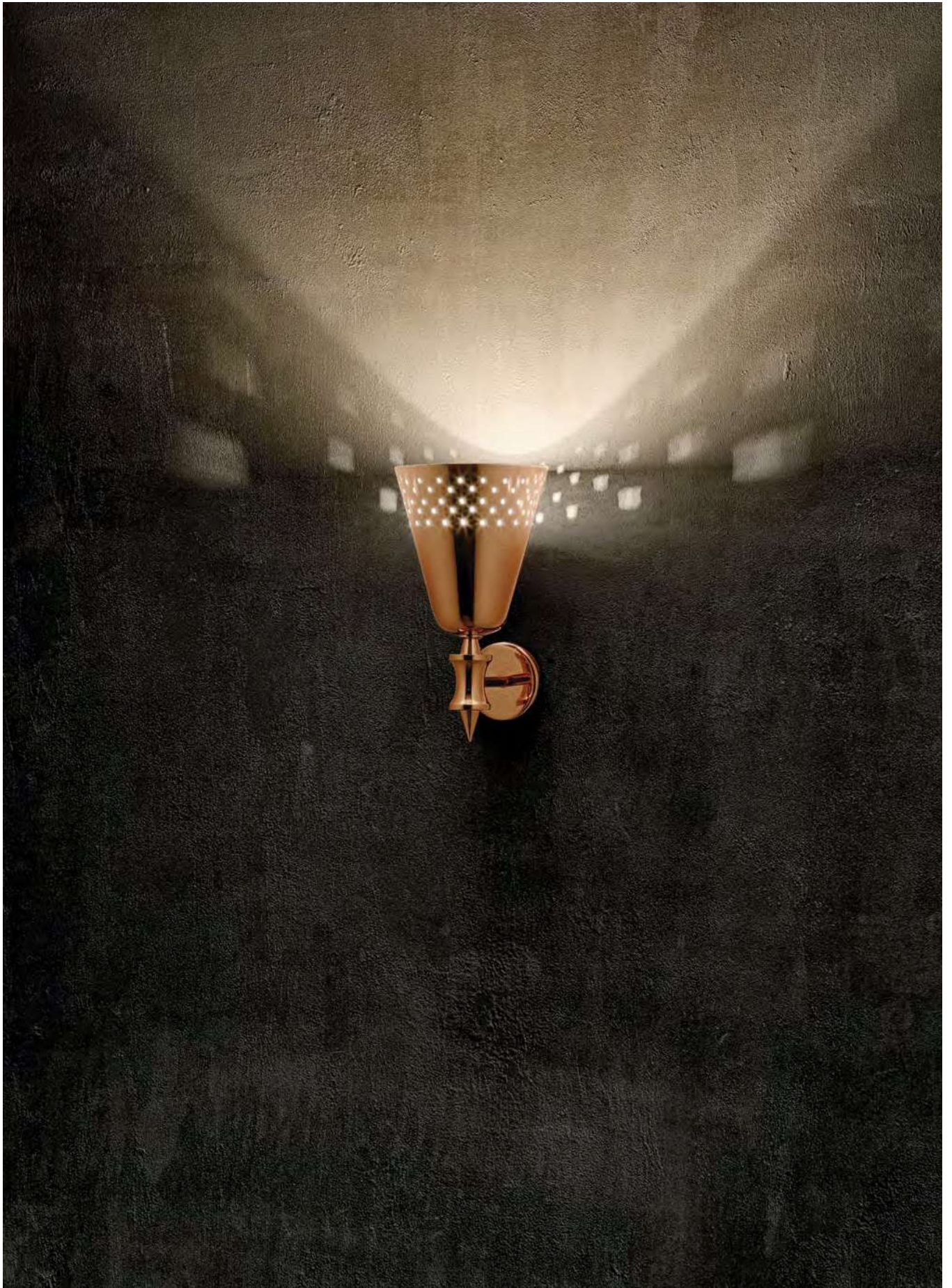

# CHUCK

## WALL LAMP

Inspired by the rock and roll world and the legendary Chuck Berry, DelightFULL has created Chuck wall light. This minimalist wall sconce is all about emotion and rhythm, conveying a vibrant feeling to any room. Its small body and mount are handmade in brass with a standard gold-plated finish, whilst the actual lampshade is built in aluminum and features a glossy black lacquer. One of the best things about this small black wall light is that you can combine multiple pieces to create a more dynamic look in your home decor. This minimalist interior wall light is the right fit for a contemporary living room decor, but it also sits well as a bedside wall lamp.

### MATERIALS

**BODY:** Brass

**SHADE:** Steel and Brass

### WEIGHT

Chuck 1 - Approx.: 1.5 kg | 3.3 lbs

Chuck 3 - Approx.: 3 kg | 6.6 lbs

### BULBS (40 w)

Chuck 1 - 1 x E14 Silver Crown Bulbs

(included) (E12 for USA not included)

Chuck 3 - 3 x E14 Reflector light Bulbs (included)

(bulbs not included for North America)

### DIMENSIONS

#### Chuck 1

**WIDTH:** 3.9" | 10 cm

**HEIGHT:** 8.3" | 21 cm

**LENGTH:** 6.7" | 17 cm

#### Chuck 3

**HEIGHT:** 17.3" | 44 cm

**WIDTH:** 3.9" | 10 cm

**DEPTH:** 6.7" | 17 cm





# COLTRANE

## WALL LAMP

Coltrane mid-century wall sconce is inspired by the famous John Coltrane and it is the perfect piece to create a beautiful lighting effect both indoors and outdoors. Handmade in steel by DelightFULL's skilled artisans, it is a great example of how less is more. This wall light fixture has matte black and gold powder paint finishes, which give it a more contemporary style. It is prepared to be used in more humid atmospheres, making it the perfect outdoor sconce. You can pair up to two iron tubes, which will help to create a statement in your modern home decor. Additionally, it can be used in more minimalist hotel rooms.



### MATERIALS

**BODY:** Aluminum

### WEIGHT

Approx.: 4 kg | 8.8 lbs

### BULBS (40 w)

4 x GU10 Bulbs (included)  
(bulbs not included for North America)

### DIMENSIONS

**HEIGHT:** 45.3" | 113 cm

**WIDTH:** 6.3" | 16 cm

**DEPTH:** 3.9" | 10 cm

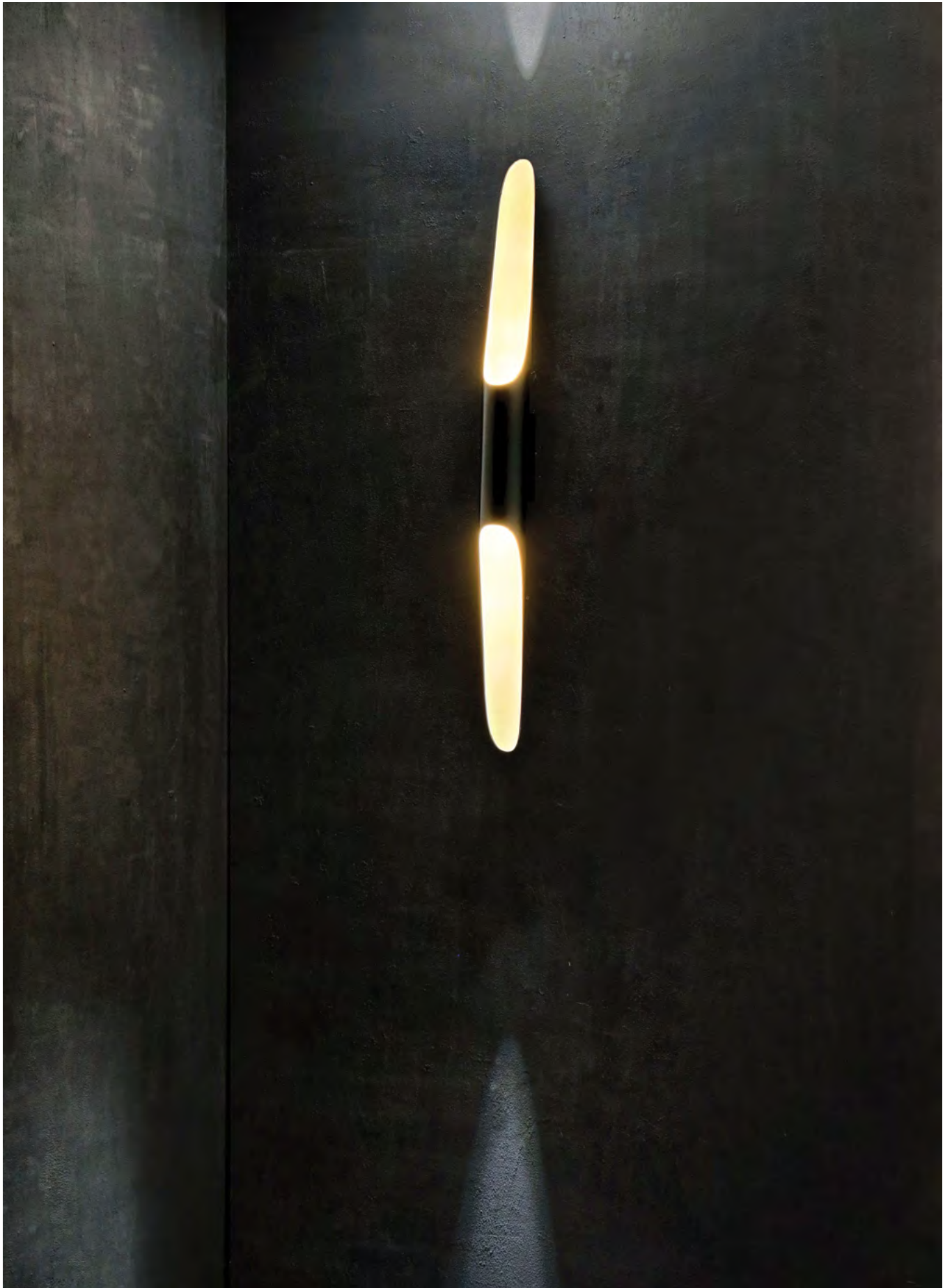

# DIANA

## WALL LAMP

Diana is a vintage industrial wall lamp, inspired by the classic designs of the mid-century modern age. A true industrial design icon, Diana has a mount and swing arm handmade in brass, with a lamp shade made in aluminum. The counterweight we find at the extremity is made out of steel for a more secure grip. There is also a switch at the top of the lamp shade, which makes it easy and comfortable to turn the lights on and off. While the mount and body boast a stunning nickel plated finish, the shade and counterweight are lacquered a glossy red, with the inside of the lamp being matte white for a smoother cast of light. Keep in mind that it can be customized using any RAL color of your choosing. It is the perfect industrial design lamp to put on display in a retro kitchen, or to use as a modern home office lighting fixture.

### MATERIALS

**BODY:** Brass  
**SHADE:** Aluminum  
**COUNTER WEIGHT:** Steel

### WEIGHT

Approx.: 7 kg | 22 lbs

### BULBS (40 w)

1 x E27 Bulb (bulbs not included for North America)

### DIMENSIONS

**HEIGHT:** 19.7" | 50 cm  
**DEPTH:** 59.1" | 150 cm  
**WIDTH:** 11.8" | 30 cm







# DIZZY

## WALL LAMP

A modern-day interpretation of the mid-century modern lighting designs produced in the 1950s and 1960s, Dizzy wall sconce is 100% designed and handmade in Portugal. This stilnovo lighting design is built in brass, with nickel plated and glossy white standard finishes, which can all be customized according to your needs and your interior design project. Due to its minimalist character, Dizzy white wall lamp is an extremely versatile piece, which can be used in almost any room of your mid-century modern home. It works great as a decorative wall light in a scandinavian style bedroom, or even as a bedside wall lamp.

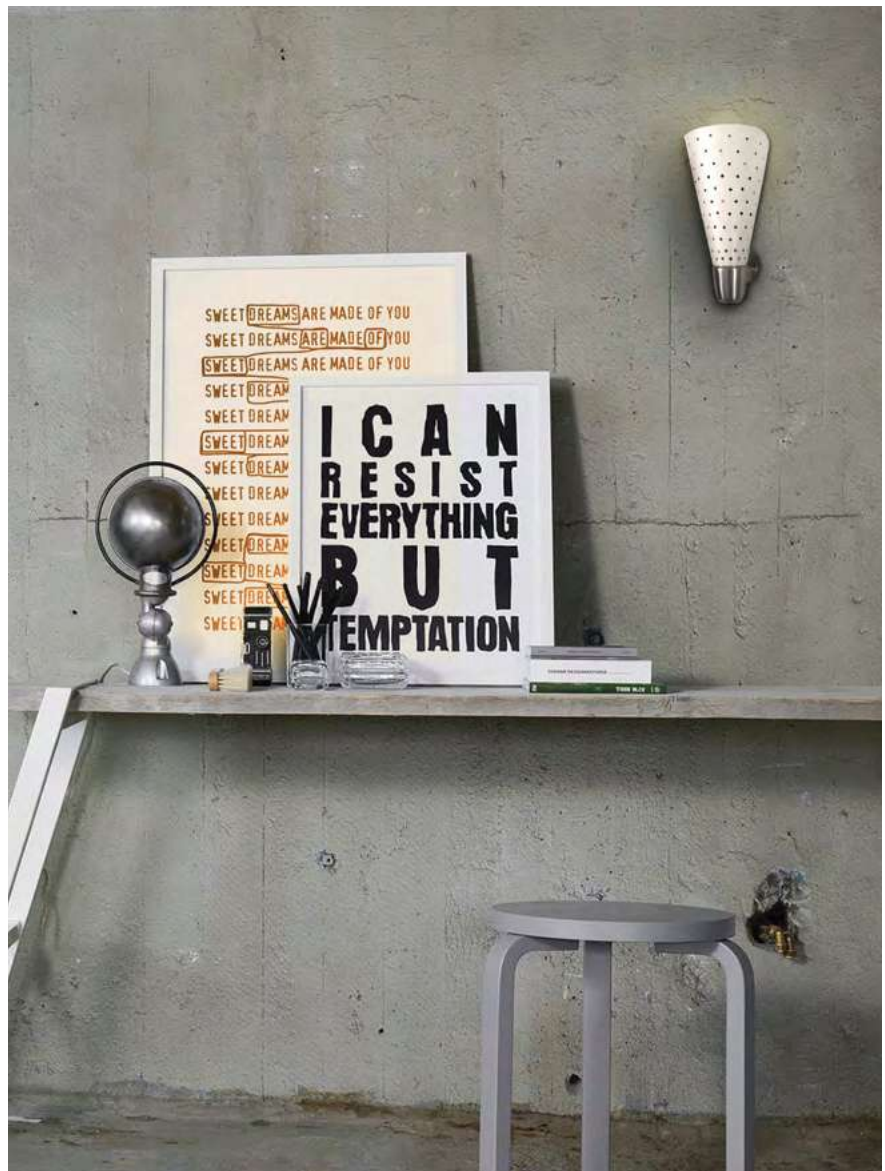

### MATERIALS

**BODY:** Brass  
**SHADE:** Brass

### WEIGHT

Approx.: 1 kg | 2.2 lbs

### BULBS (40 w)

1 x E27 Bulb (bulbs not included for North America)

### DIMENSIONS

**HEIGHT:** 16.1" | 41 cm  
**WIDTH:** 7.5" | 19 cm  
**DEPTH:** 8.7" | 22 cm

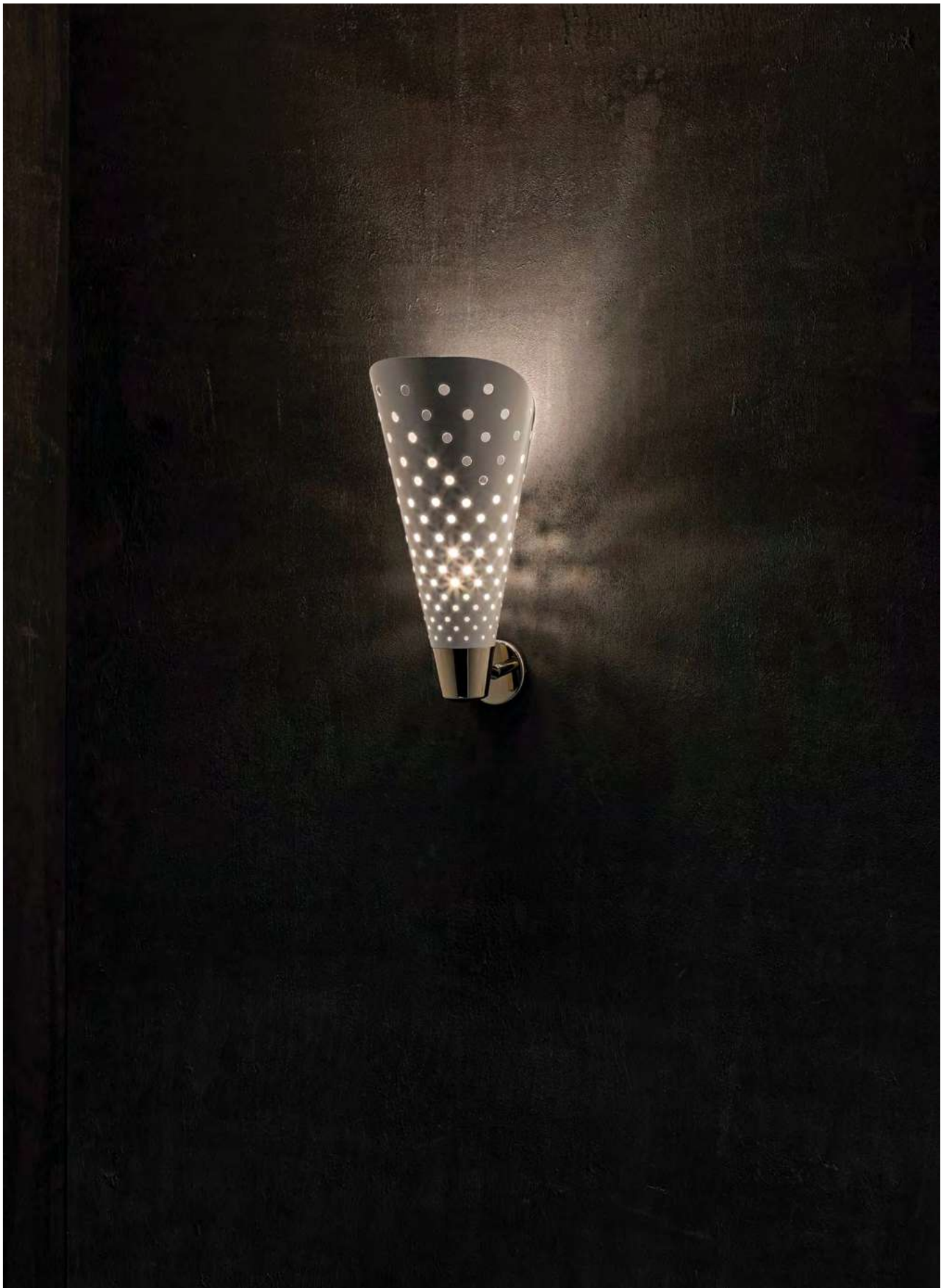

# ELLA

## WALL LAMP

Ella wall light fixture is a retro lighting design with a slight minimalist vibe that will bring a new life to your home decor. The structure of this retro wall lamp is handmade in brass, while the lampshades are built in aluminum. It features two diffusers lacquered a glossy black, which can be customized using any RAL color of your choosing. Both the lamp mount and the body feature a sleek nickel plated finish, making it perfect for contemporary home interiors. You can also use it in Scandinavian style bedrooms or living room areas to add a fun and retro touch.



### MATERIALS

**BODY:** Brass  
**SHADE:** Aluminum

### WEIGHT

Approx.: 1.5 kg | 3.3 lbs

### BULBS (40 w)

2 x G9 Bulbs (included)  
(bulbs not included for North America)

### DIMENSIONS

**HEIGHT:** 9.5" | 24 cm

**WIDTH:** 13" | 33 cm

**DEPTH:** 7.1" | 18 cm

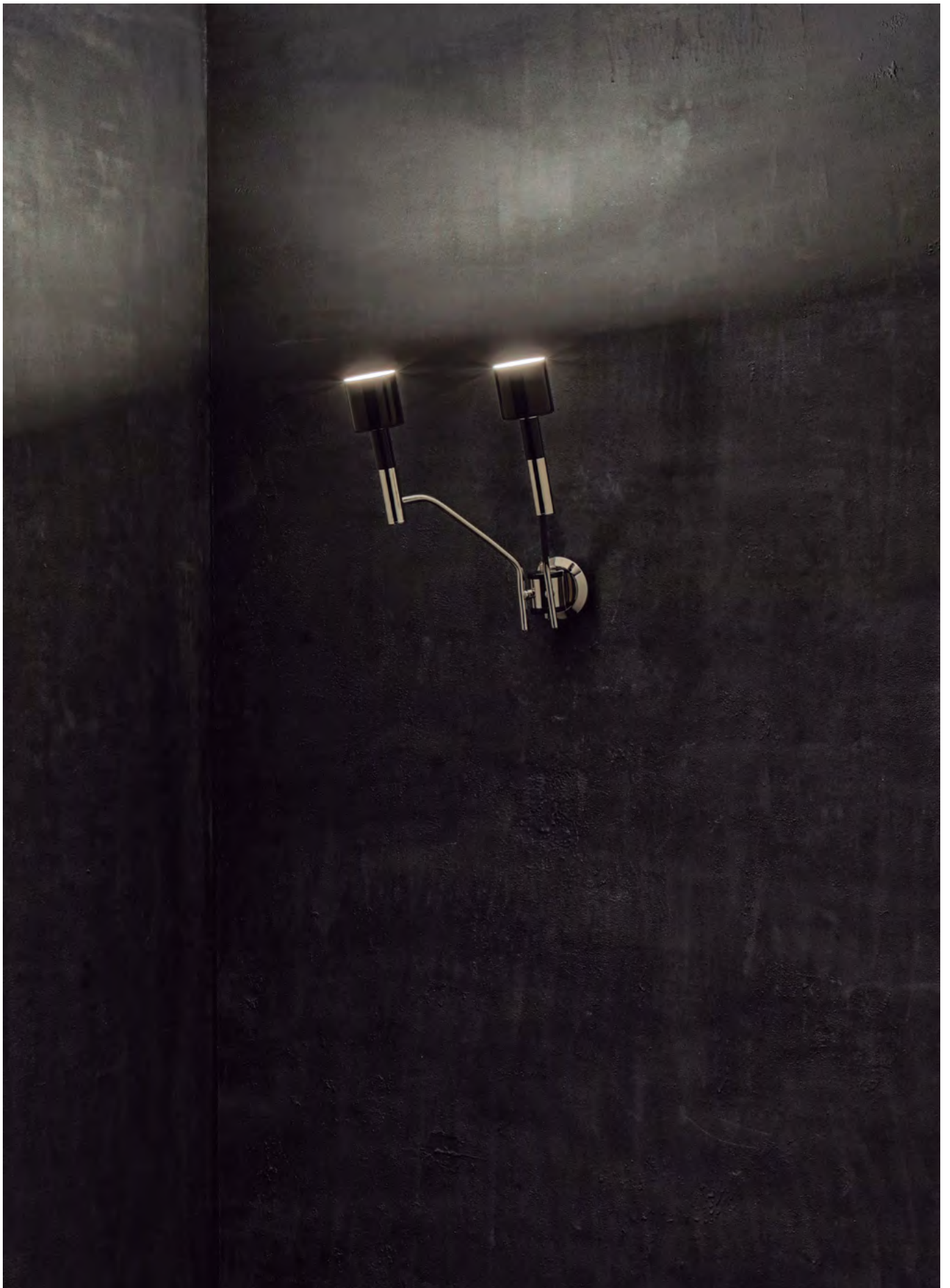

# ETTA

## WALL LAMP

Etta is one of DelightFULL's most feminine and luxurious wall lights. Inspired by the unforgettable jazz singer Etta Jones, this mid-century wall sconce can elevate any ordinary home decor to an oasis of sophistication and luxury. It is a handmade indoor wall light, with 12 brass leaves that are all shaped and assembled by hand, which convey a romantic vibe to any space. With a standard copper plated finish, Etta is a contemporary wall sconce with a trendy vibe. With almost 7 pounds and reaching 20 inches, this copper wall lamp is the perfect fit for either a classic or a trendy living room design, but it also suits a Scandinavian style home office in the most flattering way.

### MATERIALS

**BODY:** Brass

### WEIGHT

Approx.: 6 kg | 13.2 lbs

### BULBS (40 w)

4 x G9 Bulbs (included)  
(bulbs not included for North America)

### DIMENSIONS

**HEIGHT:** 20" | 50 cm

**WIDTH:** 7.1" | 18 cm

**DEPTH:** 7.1" | 18 cm



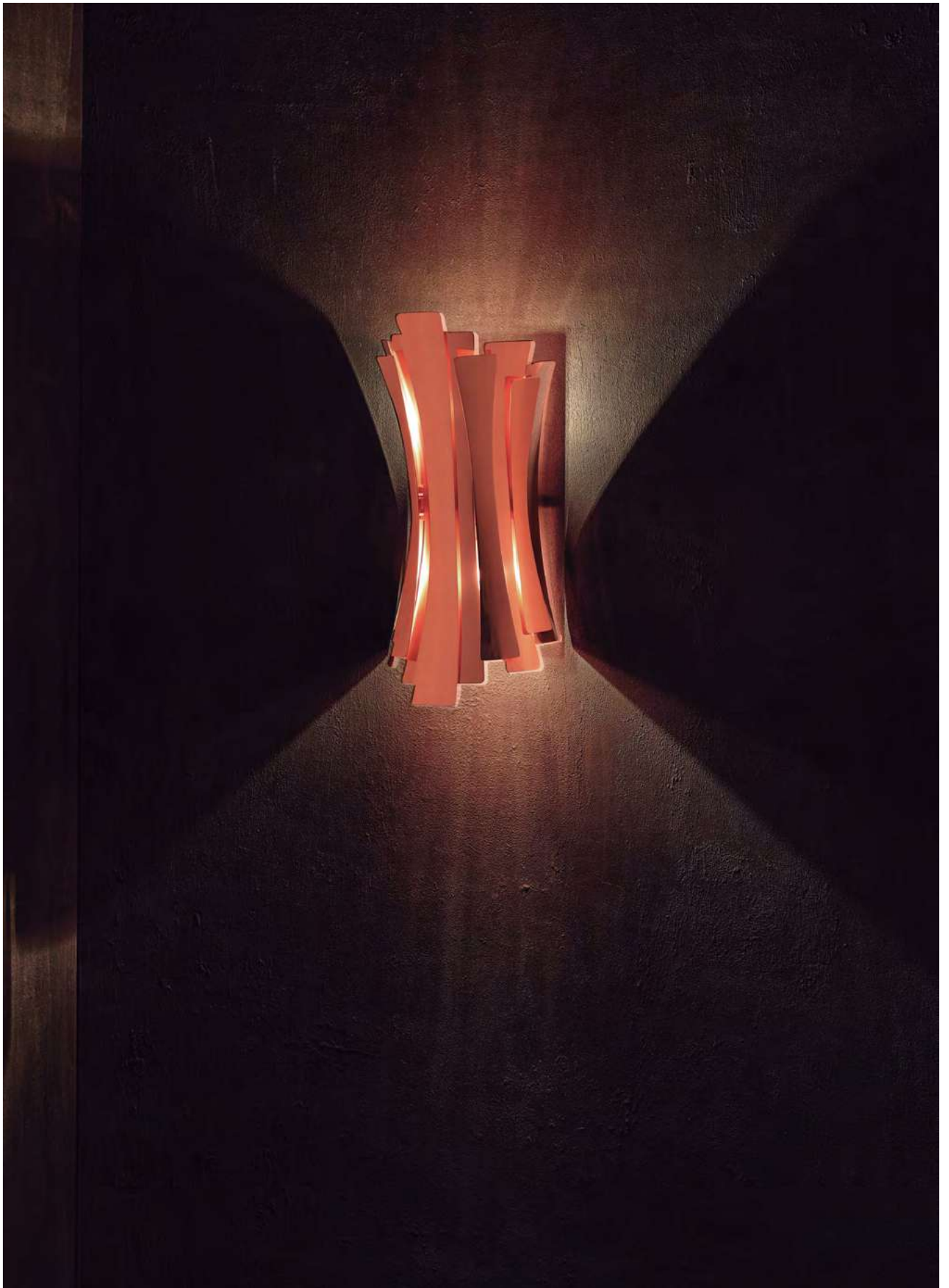

# EVANS

## WALL LAMP

Evans is a contemporary wall light with a heavy mid-century modern influence, making it an exquisite lighting design. This modern wall sconce is designed and handmade in Portugal, ensuring a high level of craftsmanship and the best final product. Both the lamp mount and the body are handmade in brass with a gold-plated finish, while the lamp shades are made of aluminum, with a standard matte black finish. This black wall light features two movable diffusers, which can be adjusted both upwards and downwards for a more comfortable ambience. This versatility makes this indoor wall lamp the perfect task light, but it does also look stunning as a bedroom wall sconce.

### MATERIALS

**BODY:** Brass  
**SHADE:** Aluminum  
**WIRE:** Textile

### WEIGHT

Approx.: 5 kg | 11 lbs

### BULBS (40 w)

2 x E27 Bulbs (included)  
(bulbs not included for North America)

### DIMENSIONS

**HEIGHT:** 25.5" | 65 cm  
**WIDTH:** 13.7" | 35 cm  
**DEPTH:** 11.8" | 30 cm



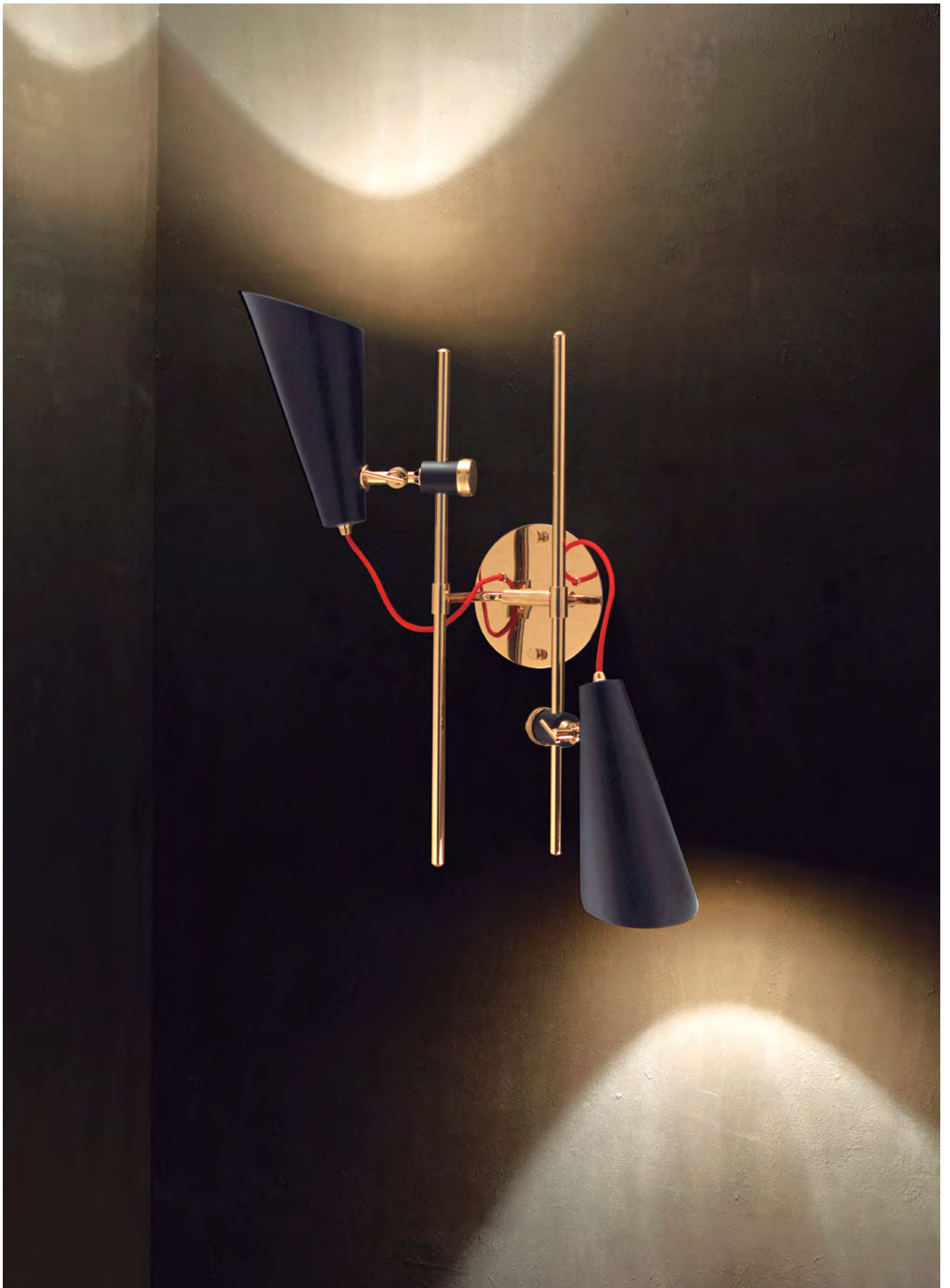



# GALLIANO

## WALL LAMP

Meet Galliano, a special modern wall lamp with a minimalist style that allows you to fit in every room of your home, regardless the style of your interior design. It's not coincidence that this black floor lamp is one of DelightFULL's top best sellers. Made of iron with a matte black exterior and a gold powder paint interior finishing, Galliano produces a unique lighting effect when you see light being casted through its pipes. You can have its finishes customized as well as the number of its tubes that can go up to 3. Ideal as a decorative bathroom wall lighting or as an entrance lighting, Galliano wall lamp will certainly elevate the decoration of your space.



### MATERIALS

**BODY:** Steel

### WEIGHT

Approx.: 2 kg | 4.4 lbs

### BULBS (40W)

4 x E27 Bulbs (included)  
(bulbs not included for North America)

### DIMENSIONS

**HEIGHT:** 19.6" | 50 cm

**WIDTH:** 5.1" | 13 cm

**DEPTH:** 3.4" | 8.5 cm

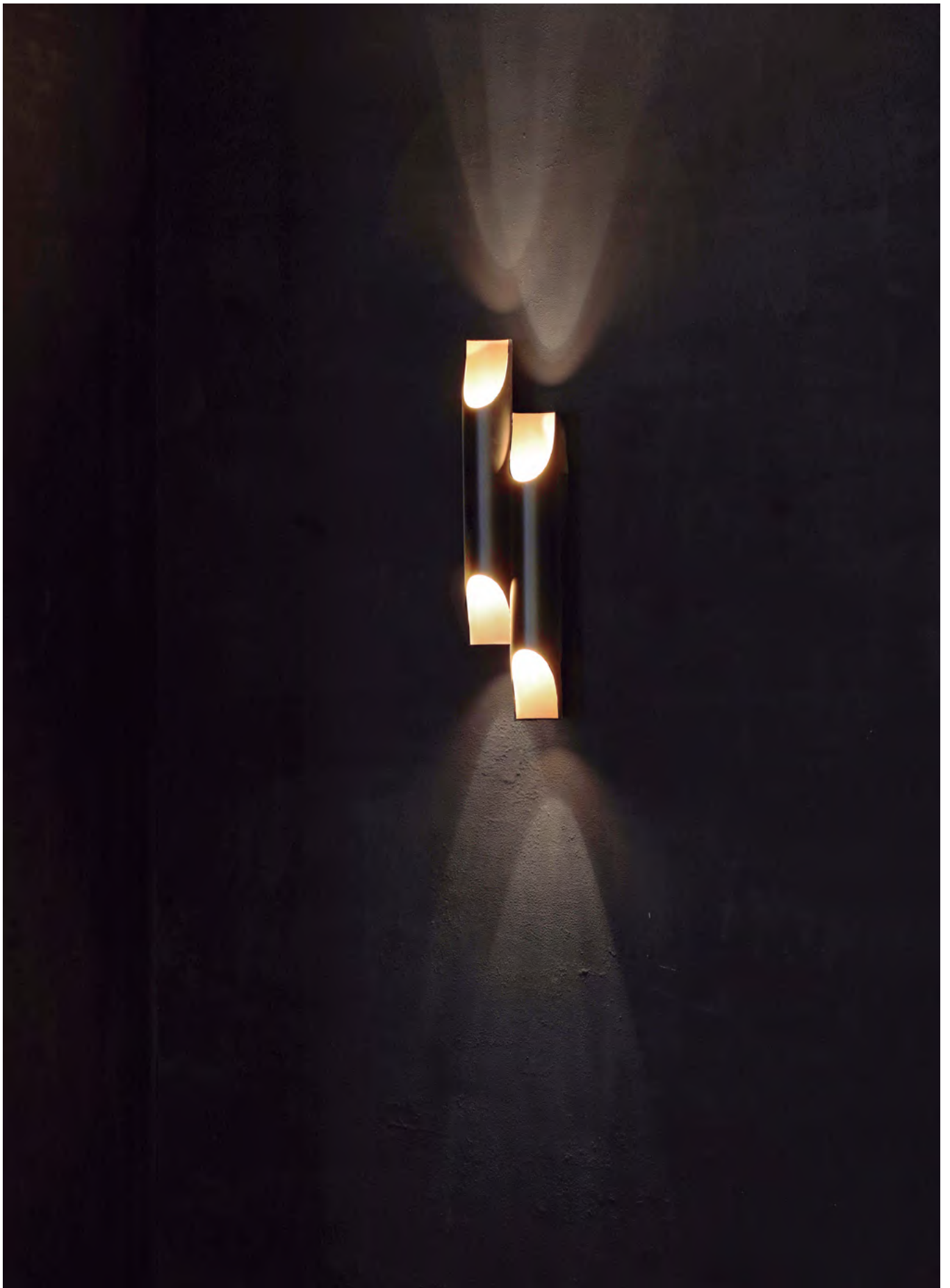

# HANNA

## WALL LAMP

Hanna is a contemporary wall lamp that will bring a smooth ambiance your mid-century modern interior. With a structure made in brass, this wall sconce is gently covered by a gold plated bath, while its aluminum lamp shade is outlined by a gold plated and matte white finish. The on/off switch is located below the lamp shade with a stylish design for a quick and easy use. This white wall lamp can be customized and instead of having one lamp shade, you can choose to have two, in order to provide a more balanced look. With a minimalist style, Hanna wall light fixture is a luxurious addition to any space. Ideal as a bathroom mirror light or as an entrance wall lighting, Hanna is a stylish lighting creation that will adorn your wall with equilibrium and dynamism.

### MATERIALS

**BODY:** Brass  
**SHADE:** Brass and Aluminum

### WEIGHT

Approx.: 2 kg | 4.4 lbs

### BULBS (40 w)

1 x E27 Bulbs (included)  
(bulbs not included for North America)

### DIMENSIONS

**HEIGHT:** 9.4" | 24 cm  
**WIDTH:** 7.1" | 18 cm  
**DEPTH:** 9.8" | 25 cm



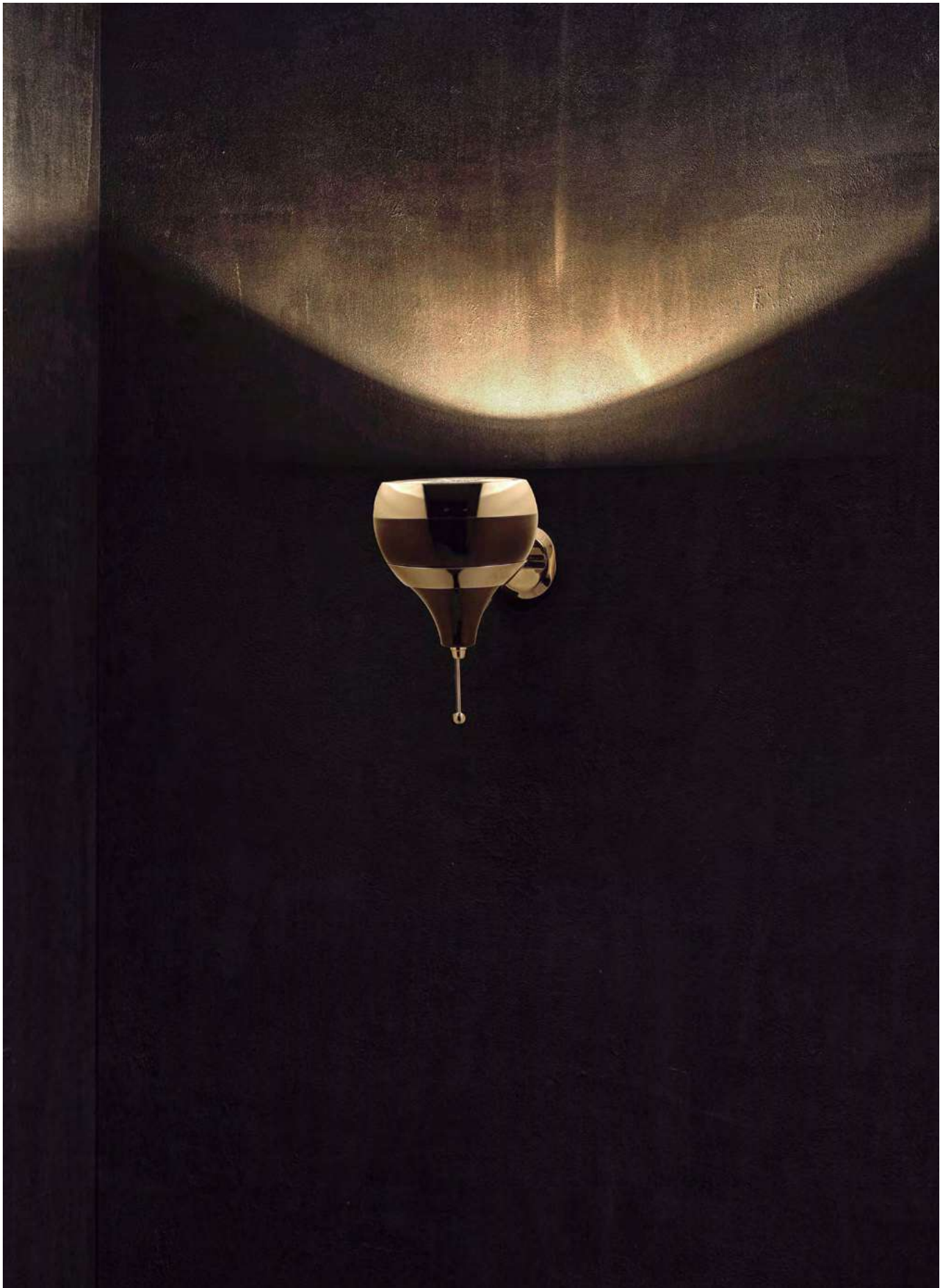

# HENDRIX

## WALL LAMP

Hendrix wall sconce has a round shape that was inspired by a golden vinyl player. Ideal for every single mid-century modern interior, this wall light fixture will bring a smooth lighting effect to your room. 100% handmade in brass, Hendrix showcases a high quality craftsmanship. With a gold plated finish, this wall light has an avant-garde design perfect for modern and contemporary environments. For this mid-century modern wall sconce you have three G9 incandescent bulbs 40W included. These three symmetric light sources cast a perfect caustic phenomena reflected that gives life to any living room decor, restaurant and bar.

### MATERIALS

**BODY:** Brass

### WEIGHT

Approx.: 2 kg | 4 lbs

### BULBS (40 w)

3x G9 Bulbs (included)  
(bulbs not included for North America)

### DIMENSIONS

**DIAM.:** 11.8" | 30 cm

**DEPTH:** 3.5" | 9 cm



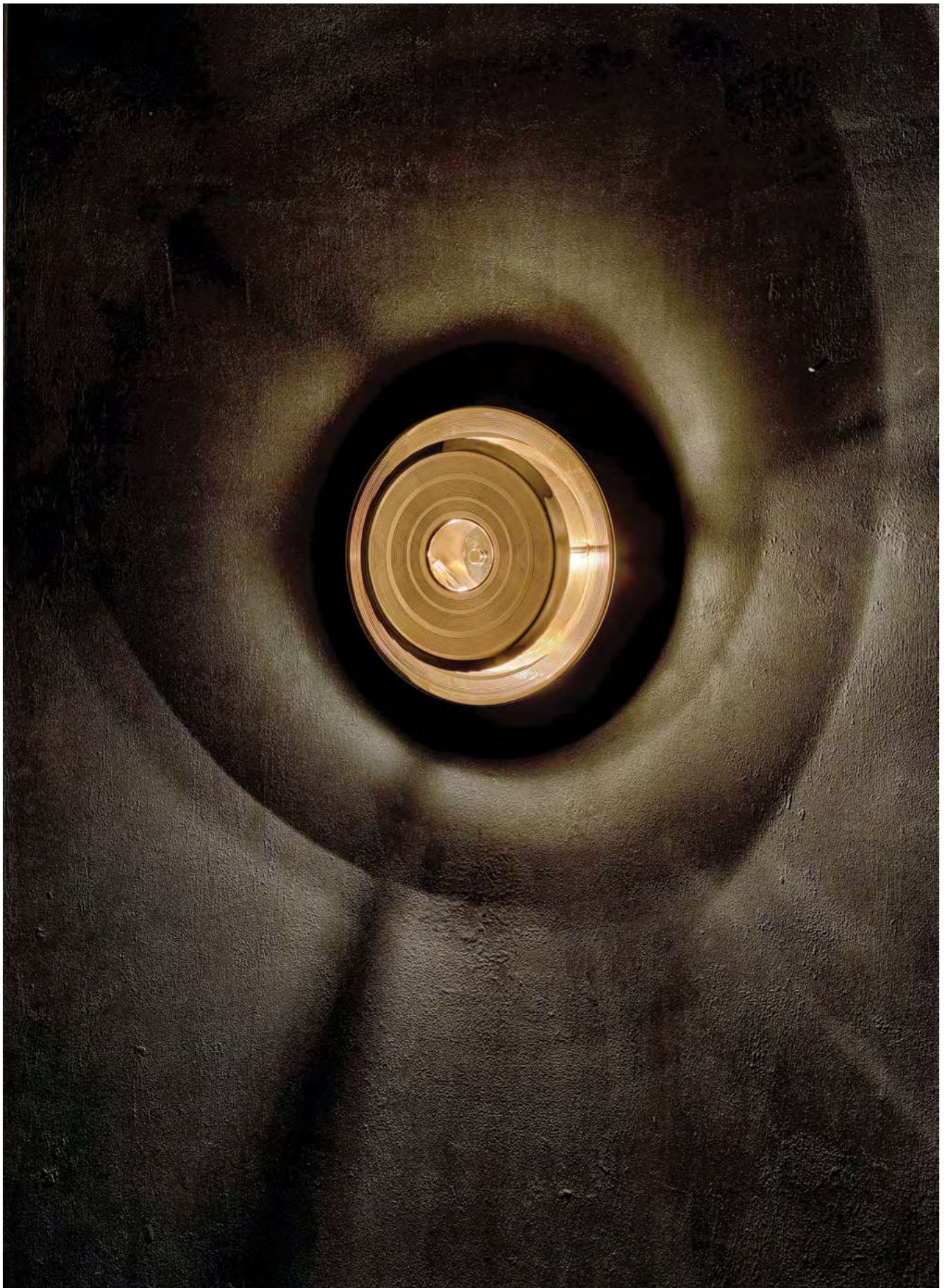

# MATHENY

## WALL LAMP

Matheny wall light has a complex and attractive geometry design of combined tubes. This unique lamp combines a mid-century modern design with a classic style that will make a statement in your home. Providing a subtle glow, this modern wall light is 100% handmade in brass and has a brushed nickel finish. With 4 lamps, we recommend you to use G9 bulbs. Ideal for your industrial kitchen or to use as a bedside reading lamp, Matheny wall light will add a smooth lighting effect to every single room of your interior design.

### MATERIALS

**BODY:** Brass

### WEIGHT

Approx.: 2 kg | 4.4 lbs

### BULBS (40 w)

4 x G9 Bulbs (included)  
(bulbs not included for North America)

### DIMENSIONS

**HEIGHT:** 12.2" | 31 cm

**WIDTH:** 7.1" | 18 cm

**DEPTH:** 4.7" | 12 cm



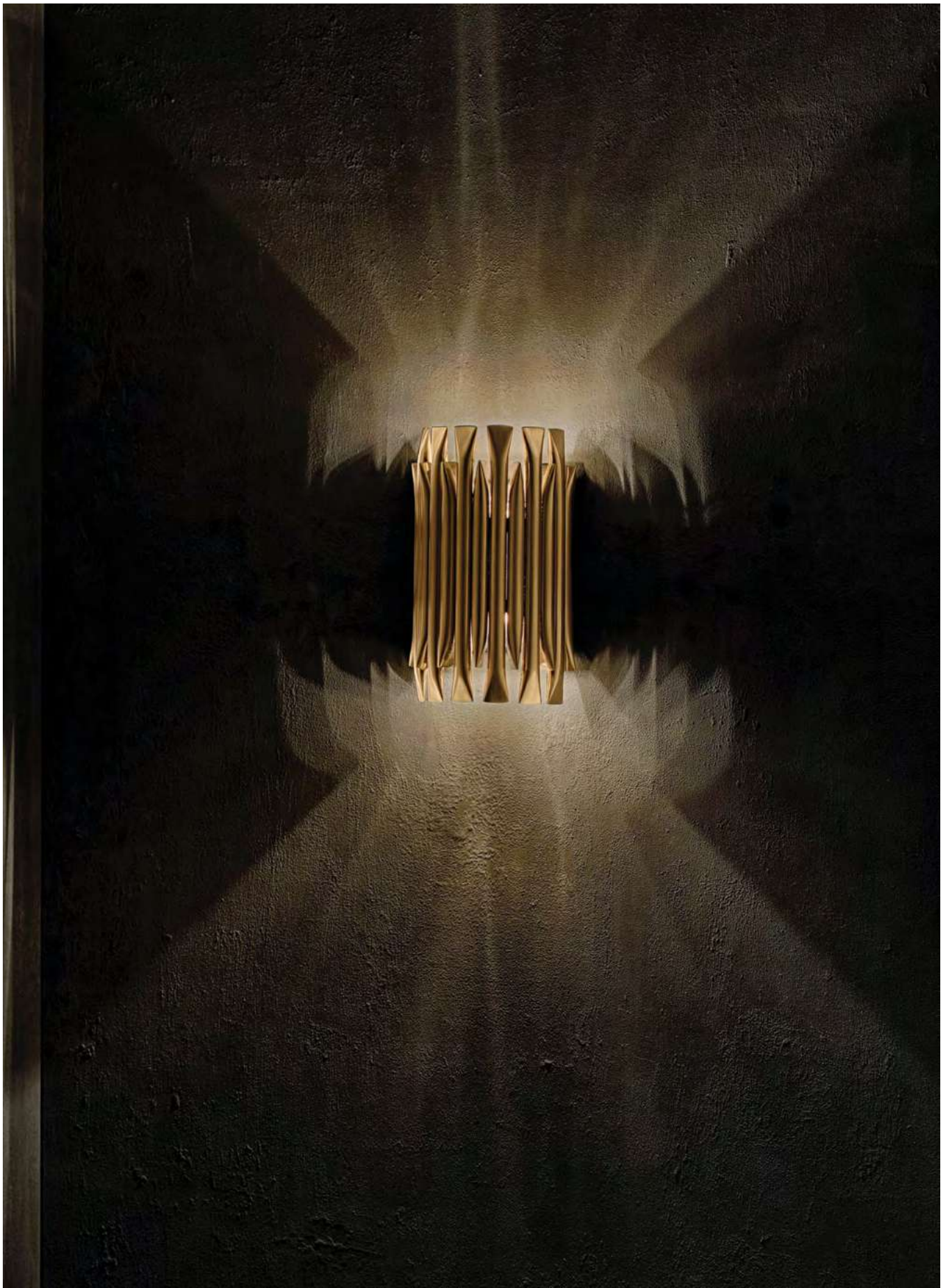



# MILES

## WALL LAMP

Miles wall lamp was inspired in one of the most influential and acclaimed figures in the history of jazz and 20th century music: Miles Davis. This modern wall light has the purpose to represent the impressive charisma of this outstanding jazz singer, in its innovative and sophisticated lighting features. Miles black wall sconce features a structure made in brass and the lamp shade in aluminum. The retro style brasswind arm is articulated to bring the light to where it's needed and boasts a matte black and gold plated finish. The drum lamp shade is finished in matte black and has gold powder paint interior finishing that makes this lamp sturdy. With a classy, intriguing contemporary silhouette, Miles mid-century modern wall sconce is the perfect bedroom wall light, since it will suit exquisitely in your interior design as your bedside reading lamp.

### MATERIALS

**BODY:** Brass  
**SHADE:** Aluminum

### WEIGHT

**Approx.:** 6 kg | 13.2 lbs

### BULBS (40W)

3 x E14 Bulbs (included)  
(bulbs not included for North America)

### DIMENSIONS

**HEIGHT:** 13.8" | 35 cm  
**WIDTH:** 13" | 33 cm  
**DEPTH:** 16.5" | 42 cm





# NORAH

## WALL LAMP

Due to its delicate and curved forms, Norah wall lamp has a vintage style that will transmit a sense of elegance and sophistication in every single space. This decorative wall light consists of five fixed arms made of brass with nickel plated and glossy black finishes. The wall lamp bulb holders are made in aluminum with a matte black finish. With five bulbs, this interior wall sconce includes E14 Bulbs (E12 for USA, not included). You can customize Norah with any RAL color of your choosing, in order to adapt this interior wall light to every room in your mid-century modern design. Going as high as 15.7 inches, Norah wall lamp will sit beautifully next to a piece of art in your living room decor.



### MATERIALS

**BODY:** Brass

**BULB HOLDER:** Aluminum

### WEIGHT

Approx.: 1 kg | 2.2 lbs

### BULBS (40 w)

5 x E14 Bulbs (included)

(bulbs not included for North America)

### DIMENSIONS

**HEIGHT:** 15.7" | 40 cm

**WIDTH:** 13.8" | 35 cm

**DEPTH:** 12.2" | 31 cm

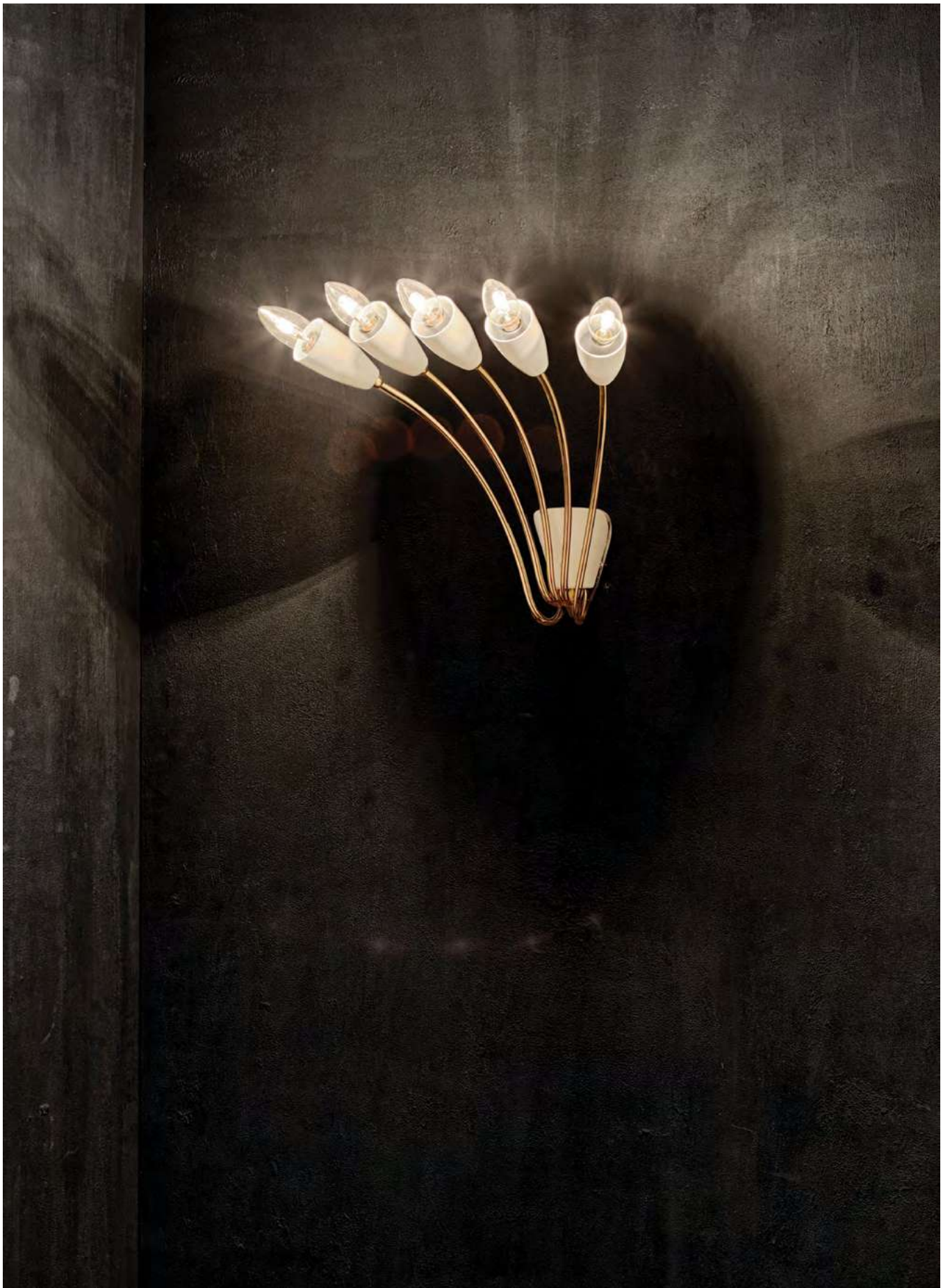

# PARKER

## WALL LAMP

Parker is a golden wall lamp with a stilnovo sconce full of jazz groove. With a mid-century modern design and with a complex, sleek design, this mid-century modern lamp is going to fit perfectly in every single room of your home design. DelightFULL's designers have created a modern wall sconce 100% handmade in brass with a gold plated finishes. However, you can customize the finishes of this mid-century modern lamp in order to look better in your interior style. All in all, its sophisticated golden brass tubes will light up the finest restaurants, lobbies and contemporary settings. We recommend you to use G9 bulbs (included).



### MATERIALS

**BODY:** Brass

### WEIGHT

Approx.: 12 kg | 26.5 lbs

### BULBS (40 w)

4 x G9 Bulbs (included)  
(bulbs not included for North America)

### DIMENSIONS

**HEIGHT:** 23.6" | 60 cm

**WIDTH:** 7.1" | 18 cm

**DEPTH:** 4.7" | 12 cm

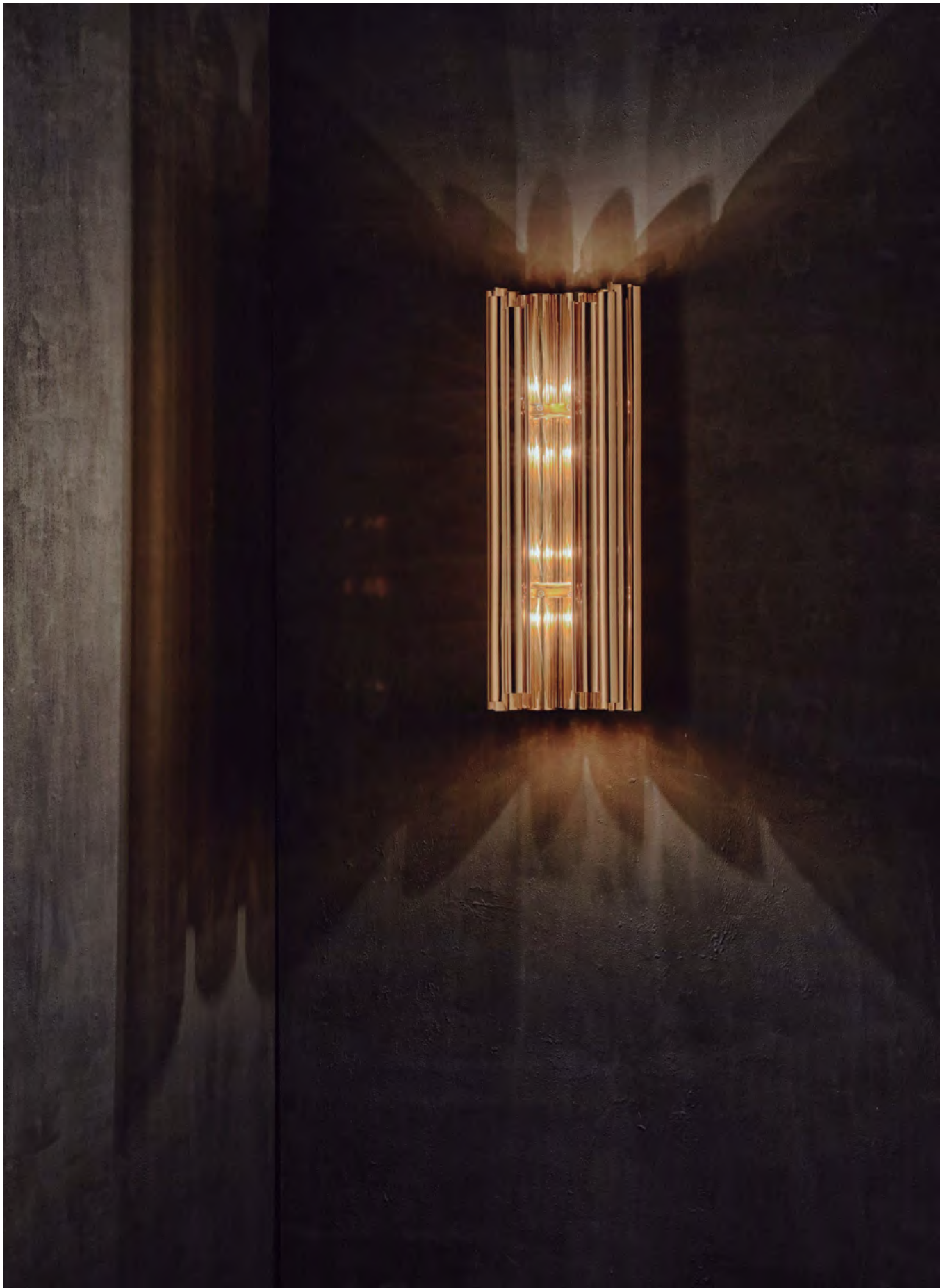

# PASTORIUS

## WALL LAMP

Pastorius wall lamp has an industrial chic style and features swing arms that are an American classic. Sophisticated and modern, Pastorius arm lamp complement any interior design. Its extendable arm built of brass can be adjusted into different positions and extends up to 26". The handle made of steel with a matte black finishing gives you the possibility to adjust the lamp shade upwards or downwards. With a vintage feeling, the flexible lamp shade has matte black exterior and a matte white interior finishing. Pastorius accordion extension and adjustable head make this industrial wall sconce perfect as a bedside reading lamp or as a workbench lighting.

### MATERIALS

**BODY:** Brass  
**SHADE:** Aluminum  
**HANDLE:** Steel  
**WIRE:** Textile

### WEIGHT

Approx.: 3 kg | 8.8 lbs

### BULBS (40 w)

1 x E27 Bulb (included)  
 (bulbs not included for North America)

### DIMENSIONS

**HEIGHT:** 10" | 25 cm  
**DEPTH:** Min. 12" | 30 cm- Max. 25.6" | 65 cm  
**WIDTH:** 5.9" | 15 cm







# PIAZZOLLA

## WALL LAMP

Piazzolla wall fixture is a pure 60's stlilnovo style that brings a retro touch to contemporary spaces. Featuring two aluminum cones, this wall light fixture offers light both from top and bottom lamp shades to provide a subtle glow. With a dynamic and versatile look that can be applied to any setting, Piazzolla wall lamp can be mounted horizontally or vertically. Its structure is made in brass with a nickel plated finish, while one of the lamp shades has a brushed nickel finish and the other has a matte black finish. The interior finishing of the shades is matte white. However, custom made versions can be done upon request, allowing you to customize the two lamp shades as you like. With double cone swiveling pinhole lights, Piazzolla wall light is the perfect lamp for your mid-century modern office and retro living room.

### MATERIALS

**BODY:** Brass

**SHADE:** Brass and Aluminum

### WEIGHT

Approx.: 1.2 kg | 2.6 lbs

### BULBS (40 w)

2x E27 Bulb (included)

(bulbs not included for North America)

### DIMENSIONS

**HEIGHT:** 11.2" | 28.5 cm

**WIDTH:** 5.7" | 14.5 cm

**DEPTH:** 7.5" | 19 cm



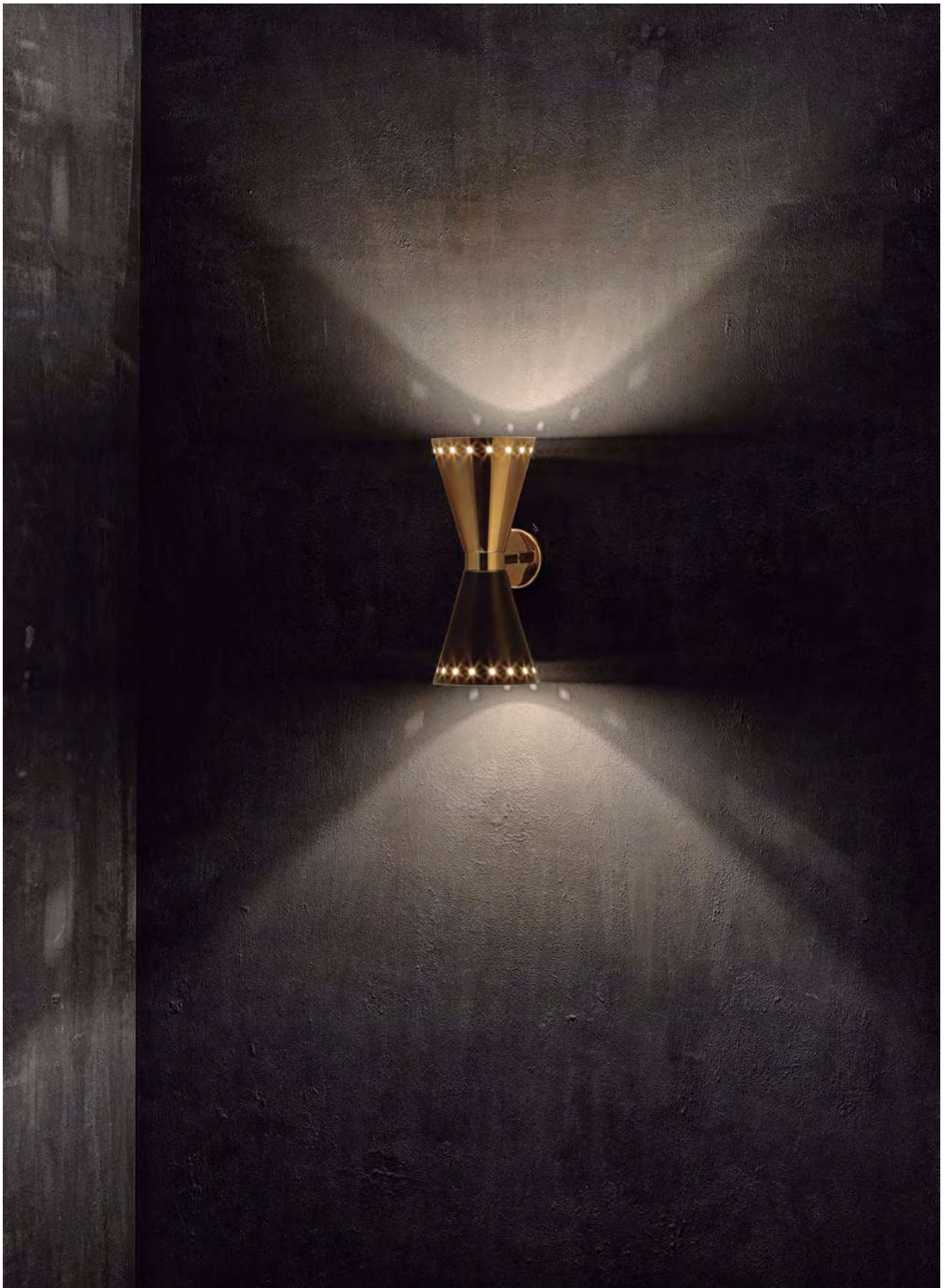

# SIMONE

## WALL LAMP

Simone wall lamp has a sleek, utilitarian design that brings a vintage flair to mid-century modern interiors. With a glossy white shade and a textile red wire, the vintage wall light fits in with a wide array of color schemes and styles. The three fully flexible arms are made of aluminum and the structure in brass, boasting three cone lampshades with gold plated accents. This mid-century modern sconce is easily adjustable when in need of a reading light, especially as a bedside lamp, or if you are simply looking to light up your hallway.

### MATERIALS

**BODY:** Brass  
**SHADE:** Aluminum  
**WIRE:** Textile

### WEIGHT

Approx.: 9 kg | 19.8 lbs

### BULBS (40 w)

3 x E27 Bulb (included)  
(bulbs not included for North America)

### DIMENSIONS

**HEIGHT:** 45.7" | 116 cm  
**WIDTH:** 17.7" | 45.5 cm  
**DEPTH:** 17.7" | 45.5 cm





# TURNER

## WALL LAMP

Turner is the perfect vintage addition to the Heritage Collection of DelightFULL. With 5 oval arcs made in brass, this vintage wall light was inspired by Tina Turner's electrifying dance moves. Turner wall light features a small lamp shade made in aluminum lacquered a matte white. Its structure is 100% handmade in brass with a gold plated finish, adding an elegant and sophisticated touch to this unique wall sconce lighting. For this interior wall light, we advise you to use a E27 bulb. This art deco wall lamp suits flawlessly above a mid-century modern sideboard or as an entrance lighting.

### MATERIALS

**BODY:** Brass

**SHADE:** Aluminum

### WEIGHT

Approx.: 5.7 kg | 12.6 lbs

### BULBS (40 W)

1 x E27 Bulb (included)

(bulbs not included for North America)

### DIMENSIONS

**HEIGHT:** 11.8" | 30 cm

**WIDTH:** 37.4" | 95 cm

**DEPTH:** 12.6" | 32 cm







POE

PK

POE

PK



*Grap  
Shic  
lamp  
collection*



## Graphic Collection

LIGHTING YOUR WORDS



---

*"The 50's retro style refashioned by DELIGHTFULL's modern design twist".*

---

Non-conventional and juicy: here they are, the colorful and extremely communicative graphic lamps made for Delightfull's new collection. Ideal for hotels and clubs, these floor, table and wall fixtures will revolutionize the lighting concepts, arriving in form of letters, numbers or symbols. Each lighting letter is based on a wide selection of iconic type fonts with a Delightfull twist. Each letter seems to talk and to impose a respectful position. Astonish yourself with the explosive "M" lighting letter featuring its complex body composed by aluminum, brass, acrylic and iron.

Between an electrifying "P" or a super pop "K". And if you have one date that you totally want to mark forever, the numbers graphic lamps will do it for you: easy, easy. It's possible to create a lighting environment full of a vibrating energy: the word you choose will be highlighted in a new unique way through the filament and neon bulbs that will flash your eyes. We must say: personality has arrived with these juicy graphic lamps.

B

1



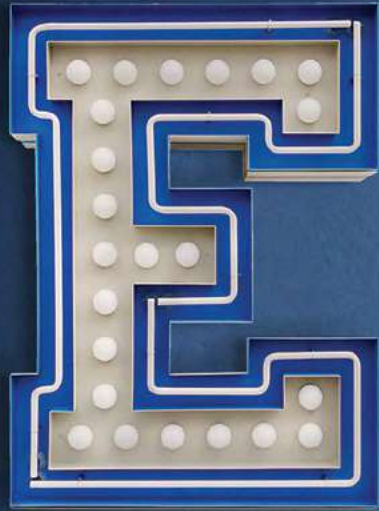

# Graphic lamp collection



H. 39.4" | 100 cm  
W. 39" | 99 cm  
D. 7.9" | 20 cm  
Lighting: 45W - Gold Neon\*  
Finishes: Polished Brass and RAL - Glossy Jet Black



H. 39.4" | 100 cm  
W. 28" | 71 cm  
D. 7.9" | 20 cm  
Lighting: 45W - White Neon\*  
Finishes: Brass and RAL - Glossy Jet Black and Cobalt Blue



H. 41.7" | 106 cm  
W. 35.6" | 90 cm  
D. 7.9" | 20 cm  
Lighting: 35W - White LED\*  
Finishes: Polished Stainless Steel and RAL - Glossy Jet Black



H. 39.4" | 100 cm  
W. 22" | 56 cm  
D. 7.9" | 20 cm  
Lighting: 48W - 16x E27 Bulbs  
Finishes: Polished Stainless Steel and RAL - Matte Signal Red



H. 39.5" | 105 cm  
W. 29.1" | 74 cm  
D. 7.9" | 20 cm  
Lighting: 116W - Cyan Neon and 23x E27 Bulbs. Finishes: RAL - Glossy Sky Blue and Silk Grey



H. 39.4" | 100 cm  
W. 22.4" | 57 cm  
D. 7.9" | 20 cm  
Lighting: 45W - Green Neon\*  
Finishes: Polished Stainless Steel and RAL - Matte Emerald Green and Jet Black



H. 39.4" | 100 cm  
W. 39" | 100 cm  
D. 7.9" | 20 cm  
Lighting: 40W - Orange LED\*  
Finishes: Polished Stainless Steel



H. 39.5" | 105 cm  
W. 29.1" | 74 cm  
D. 7.9" | 20 cm  
Lighting: 72W - 23x E27 Bulbs  
Finishes: Polished Stainless Steel and RAL - Glossy Jet Black and Matte Traffic Yellow



H. 39.5" | 105 cm  
W. 20.7" | 53 cm  
D. 7.9" | 20 cm  
Lighting: 75W - Orange Neon and 9x White E27 Bulbs.  
Finishes: RAL - Glossy Sky Blue and Deep Orange



H. 42" | 109 cm  
W. 33.7" | 86 cm  
D. 7.9" | 20 cm  
Lighting: 70W - Yellow Neon and White LED\*.  
Finishes: RAL - Matte Flame Red, Traffic Yellow and Pearl Gold



H. 39.4" | 100 cm  
W. 55.5" | 141 cm  
D. 7.9" | 20 cm  
Lighting: 132W - 44 x White E27 Bulbs.  
Finishes: RAL - Matte Flame Red and Pearl Ruby Red



H. 39.4" | 100 cm  
W. 13.8" | 35 cm  
D. 7.9" | 20 cm  
Lighting: 15W - Pink LED\*  
Finishes: Polished Brass



H. 39.5" | 105 cm  
W. 46.3" | 118 cm  
D. 7.9" | 20 cm  
Lighting: 120W - Rainbow Neons\*  
Finishes: RAL - Matte Jet Black



H. 39.4" | 100 cm  
W. 43.5" | 111 cm  
D. 7.9" | 20 cm  
Lighting: 126W - 42x White E27 Bulbs  
Finishes: RAL - Matte Rose and Glossy Light Ivory



H. 39.4" | 100 cm  
W. 30.2" | 78 cm  
D. 7.9" | 20 cm  
Lighting: 35W - RGB LED\*  
Finishes: Anodized Black



H. 39.4" | 100 cm  
W. 38.4" | 98 cm  
D. 7.9" | 20 cm  
Lighting: 35W - White LED\*  
Finishes: Polished Stainless Steel, RAL - Glossy Flame Red and Acrylic



H. 39.4" | 100 cm  
W. 39.4" | 100 cm  
D. 7.9" | 20 cm  
Lighting: 45W - Turquoise Neon\*  
Finishes: RAL - Glossy Light Green and Cream White



H. 39.4" | 100 cm  
W. 39.4" | 100 cm  
D. 7.9" | 20 cm  
Lighting: 66W - 21x E27 Bulbs  
Finishes: Worn Out Paint and Rusty



H. 39.4" | 100 cm  
W. 41.3" | 105 cm  
D. 7.9" | 20 cm  
Lighting: 45W - Bright Pink Neon\*  
Finishes: Polished Stainless Steel and RAL - Glossy Purple Violet and Signal Violet



H. 39.4" | 100 cm  
W. 35" | 89 cm  
D. 7.9" | 20 cm  
Lighting: 75W - Green Neon and White LED\*.  
Finishes: Polished Stainless Steel and RAL - Glossy Leaf Green

# Graphic lamp collection



H. 39.4" | 100 cm  
W. 34.7" | 88 cm  
D. 7.9" | 20 cm  
Lighting: 45W - White Neon\*  
Finishes: Stainless Steel, Diamond Plated and RAL - Glossy Jet Black and Pure Orange\*



H. 39.4" | 100 cm  
W. 45.3" | 115 cm  
D. 7.9" | 20 cm  
Lighting: 50W - Red, LED\*  
Finishes: Brushed Copper and RAL - Matte Brown Red



H. 39.4" | 100 cm  
W. 62.2" | 158 cm  
D. 7.9" | 20 cm  
Lighting: 36W - White LED\*  
Finishes: Polished Stainless Steel



H. 39.4" | 100 cm  
W. 36.8" | 94 cm  
D. 7.9" | 20 cm  
Lighting: 76W - Red Neon\*  
Finishes: RAL - Matte Jet Black and Glossy Carmine Red



H. 39.4" | 100 cm  
W. 38.8" | 99 cm  
D. 7.9" | 20 cm  
Lighting: 45W - Green Neon\*  
Finishes: Polished Stainless Steel and RAL - Glossy Signal Green



H. 39.4" | 100 cm  
W. 39.4" | 100 cm  
D. 7.9" | 20 cm  
Lighting: 120W - CMYK Neons\*  
Finishes: Polished Stainless Steel and RAL - Matte Jet Black



H. 39.4" | 100 cm  
W. 19.7" | 50 cm  
D. 7.9" | 20 cm  
Lighting: 116W - Gold Neon and 16x E27 Bulbs  
Finishes: Polished Brass and RAL - Matte Leaf Green\*



H. 39.4" | 100 cm  
W. 38.2" | 97 cm  
D. 7.9" | 20 cm  
Lighting: 45W - Blue Neon\*  
Finishes: Polished Brass and RAL - Glossy Traffic Blue



H. 39.4" | 100 cm  
W. 15.2" | 39 cm  
D. 7.9" | 20 cm  
Lighting: 36W - 12x E27 Bulbs  
Finishes: Brushed Cooper, RAL - Glossy Traffic Yellow and Traffic Blue



H. 39.4" | 100 cm  
W. 27.4" | 70 cm  
D. 7.9" | 20 cm  
Lighting: 60W - 20x E27 Bulbs  
Finishes: Polished Stainless Steel, RAL - Matte Flame Red



H. 39.4" | 100 cm  
W. 27" | 69 cm  
D. 7.9" | 20 cm  
Lighting: 45W - Green Neon\*  
Finishes: Brushed Copper, RAL - Matte Moss Green



H. 39.4" | 100 cm  
W. 15.7" | 40 cm  
D. 7.9" | 20 cm  
Lighting: 35W - White LED\*  
Finishes: Polished Stainless Steel



H. 39.4" | 100 cm  
W. 26.8" | 68 cm  
D. 7.9" | 20 cm  
Lighting: 45" - Yellow Neon\*  
Finishes: RAL - Matte Traffic Yellow and Emerald Green



H. 39.4" | 100 cm  
W. 29.3" | 75 cm  
D. 7.9" | 20 cm  
Lighting: 28W - Yellow LED\*  
Finishes: RAL - Matte Night Blue



H. 39.4" | 100 cm  
W. 37.8" | 96 cm  
D. 7.9" | 20 cm  
Lighting: 87W - 14x White E27 Bulbs  
Finishes: Polished Brass and RAL - Glossy Flame Red and Capri Blue

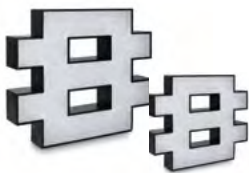

H. 39.4" | 100 cm  
W. 47.2" | 120 cm  
D. 7.9" | 20 cm  
Lighting: 36W - RGB LED\*  
Finishes: RAL - Matte Jet Black



H. 39.4" | 100 cm  
W. 34.3" | 87 cm  
D. 7.9" | 20 cm  
Lighting: 45W - Cyan Neon\*  
Finishes: RAL - Matte Jet Black, Glossy Light Blue and Window Grey

\*Suitable for outdoor use  
Mini Graphic Collection Also Available H. 19.7" | 50 cm

## METAL FINISHES

FOR THE BODY OR SHADE OF ANY LIGHT FIXTURE



Polished Brass

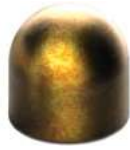

Aged Brass



Brushed Brass



Gold Plated



Gold Matte



Brushed Gold



Nickel Plated



Nickel Matte



Brushed Nickel



Black Nickel Plated



Black Nickel Matte



Brushed Black Nickel



Copper Plated



Copper Matte



Brushed Copper

## CORDS

more cords available on extra charge



Bright Red - textile



Jet Black - textile



Jet Black - rubber



Antique White - textile

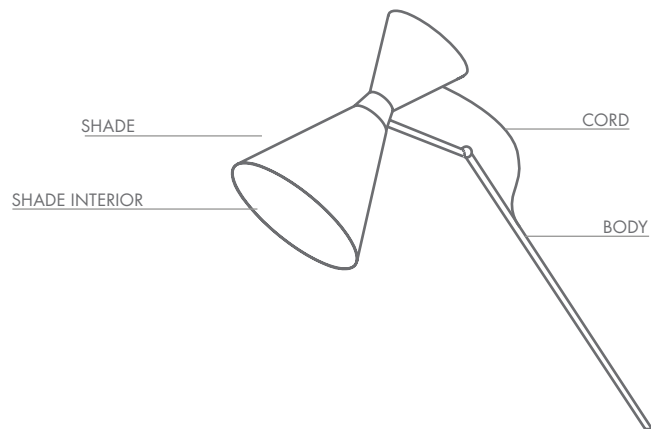

---

## LACQUERED COLORS

---

ENHANCE THE LIGHT EFFECT FOR THE INTERIOR OF EACH SHADE  
OR USE ANY STANDARD LACQUERED COLOR



Glossy White



Matte White

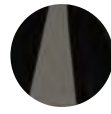

Glossy Black



Matte Black



Glossy Grey



Matte Grey



Glossy Yellow

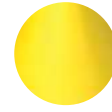

Matte Yellow



Glossy Blue



Matte Blue

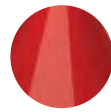

Glossy Red



Matte Red

---

## STONES

---

FOR THE BASE OF ANY LAMP  
more stones available on extra charge



Carrara Marble



Estremoz Marble



Nero Marquina Marble

---

## POWDER PAINTS

---

FOR THE BODY OR SHADE OF ANY LIGHT FIXTURE  
Any RAL color available on extra charge



Gold Powder Paint



Grey Powder Paint





# TECHNICAL CATALOGUE

---

SUSPENSION 252

---

FLOOR 276

---

TABLE 292

---

WALL 301







# SUSPENSION LAMPS



## AMY | SUSPENSION

**MATERIALS**  
 BODY: Brass and Aluminum  
 SHADE: Aluminum

**WEIGHT**  
 Approx.: 15 kg | 33 lbs

**BULBS (40W)**  
 10 x E14 Bulbs (included) (bulbs not included for North America)

**DIMENSIONS**  
 HEIGHT: 33" | 85 cm  
 Maximum Open DIAM: 37.4" | 95 cm  
 TELESCOPIC TUBE: 5.9" - 17.7" | 15 - 45 cm  
 TELESCOPIC TUBE HEIGHT: 27.5" | 70 cm  
 (customizable on purchase)

**PACKAGE**  
 (Cardboard Box)  
 Height: 34.65" | 88cm  
 Width: 33.07" | 84cm  
 Depth: 33.07" | 84cm  
 0.6209 m³/ 21 kg

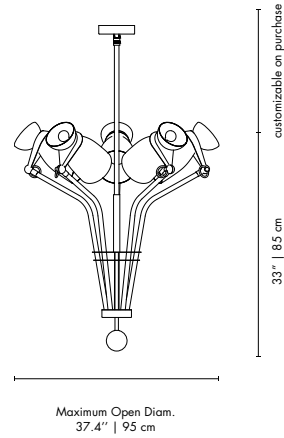

Glossy Black & Gold Plated

## ARETHA | SUSPENSION

**MATERIALS**  
 BODY: Brass  
 BULB HOLDER: Aluminum

**WEIGHT**  
 Approx.: 7 kg | 15.4 lbs

**BULBS (40W)**  
 24 x E14 Bulbs (included) (bulbs not included for North America)

**DIMENSIONS**  
 BODY HEIGHT: 12.2" | 31 cm  
 DIAM: 40.9" | 104 cm  
 STANDARD POLE HEIGHT: 39.4" | 100 cm  
 (customizable on purchase)

**PACKAGE**  
 (Cardboard Box)  
 Height: 16.93" | 43cm  
 Width: 46.67" | 116cm  
 Depth: 46.67" | 116cm  
 0.5786 m³/21 kg

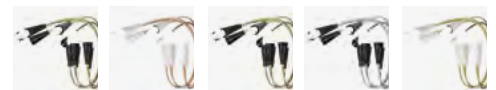
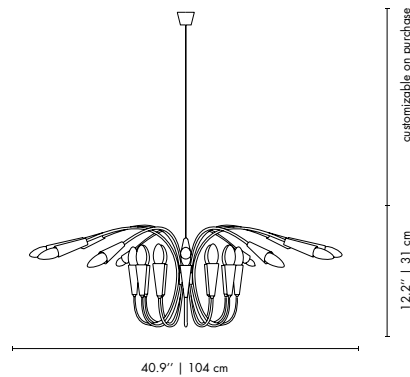

Cooper & Black Plated    Copper & White    Gold & Black    Nickel & Black    White & Gold

# ATOMIC | SUSPENSION

## MATERIALS

BODY: Brass and Steel  
SHADES: Steel

## WEIGHT

Approx: 25 kg | 55.1 lbs

## BULBS (40W)

8x G9 Bulbs (bulbs not included for North America)

## DIMENSIONS

TOTAL HEIGHT: 47.24" | 120cm

BODY HEIGHT: 28.7" | 73 cm

POLE HEIGHT: 18.5" | 47cm

STANDARD CABLE HEIGHT 100cm: (customizable on purchase)

DIAM: 31.5" | 80 cm

CORD HEIGHT: Adjustable 39.4" | 100 cm  
(customizable on purchase)

## PACKAGE

(Cardboard Box)

Height: 39.37" | 100cm

Width: 33.46" | 85cm

Depth: 33.46" | 85cm

100 x 85 x 85 cm

0.7225 m<sup>3</sup> / 27 kg

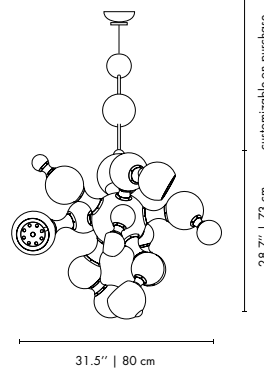

Black Glossy & Copper Plated



Glossy Black & Nickel



White Glossy & Copper



White Glossy & Gold



White Glossy & Nickel

# ATOMIC CEILING | SUSPENSION

## MATERIALS

BODY: Brass and Steel  
SHADES: Steel

## WEIGHT

Approx: 20 kg | 44 lbs

## BULBS (40W)

8x G9 Bulbs (bulbs not included for North America)

## DIMENSIONS

HEIGHT: 19.7" | 50 cm

DIAM: 34.6" | 88 cm

## PACKAGE

(Cardboard Box)

Height: 24.8" | 63cm

Width: 37.4" | 95cm

Depth: 37.4" | 95cm

0.57 m<sup>3</sup> / 32 kg

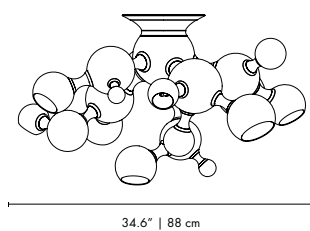

Black Glossy & Copper Plated



Glossy Black & Nickel



White Glossy & Copper



White Glossy & Gold



White Glossy & Nickel

## ATOMIC ROUND | SUSPENSION

**MATERIALS**

BODY: Brass and Steel  
 SHADES: Steel

**WEIGHT**

Approx: 25 kg | 55.1 lbs

**BULBS (40W)**

12 x G9 bulbs (included) (bulbs not included for North America)

**DIMENSIONS**

HEIGHT: 14.6" | 37 cm

DIAM: 59" | 150 cm

STANDARD CABLE HEIGHT 100cm: (customizable on purchase)

**PACKAGE**

(Cardboard Box)

45 x 135 x 135 cm

0.82 m<sup>3</sup> / 36 kg

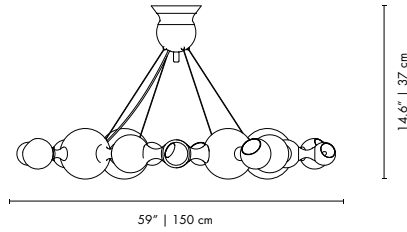

Black Glossy & Copper Plated

Glossy Black & Nickel

White Glossy & Copper

White Glossy & Gold

White Glossy & Nickel

## BASIE | SUSPENSION

**MATERIALS**

BODY: Brass  
 SHADES: Aluminum

**WEIGHT**

Approx: 20 kg | 44 lbs

**BULBS**

2 x G9 LED bulbs

3W / 3000K (included) (bulbs not included for North America)

**DIMENSIONS**

BODY HEIGHT: 13.4" | 34 cm

DIAM: 23.6" | 60 cm

STANDARD CABLE HEIGHT 100cm: (customizable on purchase)

**PACKAGE**

(Cardboard Box)

Height: 19.69" | 50cm

Width: 29.53" | 75cm

Depth: 29.53" | 75cm

0.28 m<sup>3</sup> / 14 kg

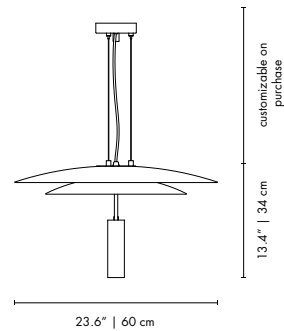

White Matte & Gold Plated



# BOTTI 90 | SUSPENSION

**MATERIALS**  
BODY: Brass

**WEIGHT**  
Approx: 11 kg | 24.3lbs

**BULBS (40W)**  
24x E27 Bulbs (bulbs not included for North America)

**DIMENSIONS**  
HEIGHT: 24" | 60 cm  
DIAM: 35" | 90 cm  
POLE HEIGHT: 27.6" | 70 cm (customizable on purchase)

**PACKAGE**  
(Cardboard Box)  
Height: 29.53" | 75cm  
Width: 43.31" | 110cm  
Depth: 43.31" | 110cm  
0.9075 m<sup>3</sup> / 30 kg

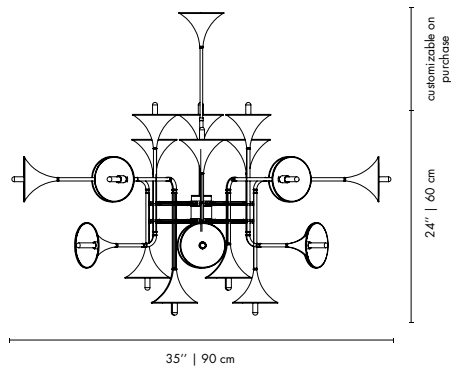

## BOTTI 150 | SUSPENSION

**WEIGHT**  
Approx: 13 kg | 28.7 lbs

**BULBS (40W)**  
24x E27 Bulbs (bulbs not included for North America)

**DIMENSIONS**  
HEIGHT: 31.5" | 80 cm  
DIAM: 59" | 150 cm  
STANDARD POLE HEIGHT: 27.6" | 70 cm (customizable on purchase)

**PACKAGE**  
(Cardboard Box)  
Height: 36.22" | 92cm  
Width: 56.3" | 143cm  
Depth: 56.3" | 143cm  
2.01 m<sup>3</sup> / 43 kg

## BOTTI 250 | SUSPENSION

**WEIGHT**  
Approx: 38 kg | 83.8 lbs

**BULBS (40W)**  
24x E27 Bulbs (bulbs not included for North America)

**DIMENSIONS**  
HEIGHT: 70.9" | 180 cm  
DIAM: 98.4" | 250 cm  
POLE HEIGHT: (customizable on purchase)

**PACKAGE**  
(Plywood Box)  
Height: 77.56" | 197cm  
Width: 48.43" | 123cm  
Depth: 48.43" | 123cm  
2.98 m<sup>3</sup> / 109 kg



# BOTTI | PENDANT

**MATERIALS**  
BODY: Brass and Steel

**WEIGHT**  
Approx: 2.5 kg | 7.7 lbs

**BULBS (40W)**  
11 x E27 Silver Crown Bulbs (included)  
(bulbs E26 not included for North America)

**DIMENSIONS**  
HEIGHT: 15.4" | 39 cm  
DIAM: 16.9" | 43 cm  
STANDARD CORD HEIGHT: 39.4" | 100 cm (customizable on purchase)

**PACKAGE**  
(Cardboard Box)  
Height: 27.56" | 70cm  
Width: 25.2" | 64cm  
Depth: 25.2" | 64cm  
0.29 m<sup>3</sup> / 25 kg

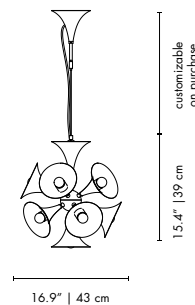

## BOTTI 32 | SUSPENSION

**WEIGHT**  
Approx: 4.5 kg | 9.9 lbs

**BULBS (40W)**  
32 x E27 Silver Crown Bulbs (included) (bulbs E26 not included for North America)

**DIMENSIONS**  
HEIGHT: 19.7" | 50 cm  
DIAM: 20.9" | 53 cm  
STANDARD CORD HEIGHT: 39.4" | 100cm (customizable on purchase)

**PACKAGE**  
(Cardboard Box)  
Height: 31.5" | 80cm  
Width: 29.13" | 74cm  
Depth: 29.13" | 74cm  
0.44 m<sup>3</sup> / 29 kg

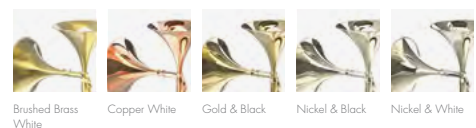

# BRUBECK | SUSPENSION

**MATERIALS**  
BODY: Brass

**WEIGHT**  
Approx.: 46 kg | 99 lbs

**BULBS (40W)**  
30 x G9 Bulbs (included) (bulbs not included for North America)

**DIMENSIONS**  
BODY HEIGHT: 17.3" | 44 cm  
DIAM: 39.3" | 100 cm  
CORD HEIGHT: 39.4" | 100 cm (adjustable)  
(customizable on purchase)

**PACKAGE**  
(Plywood Box)  
Height: 25.2" | 64cm  
Width: 43.31" | 110cm  
Depth: 43.31" | 110cm  
0.77 m<sup>3</sup> / 72 kg

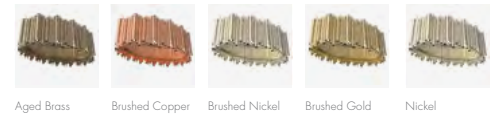
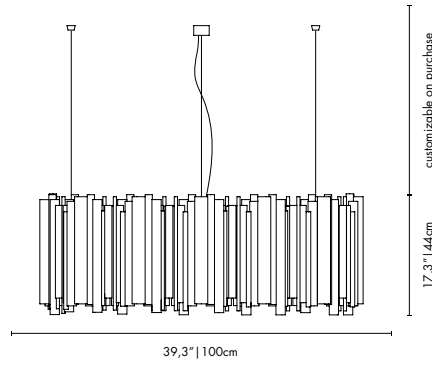

# BRUBECK | PENDANT

**MATERIALS**  
BODY: Brass

**WEIGHT**  
Approx.: 4.5 kg | 9.9 lbs

**BULBS (40W)**  
6 x G9 Bulbs (included) (bulbs not included for North America)

**DIMENSIONS**  
BODY HEIGHT: 17.3" | 44 cm  
DIAM: 5.1" | 13 cm  
CORD HEIGHT: 39.4" | 100 cm (customizable on purchase)

**PACKAGE**  
(Cardboard Box)  
Height: 23.62" | 60cm  
Width: 11.81" | 30cm  
Depth: 8.66" | 22cm  
0.04m<sup>3</sup> / 6Kg

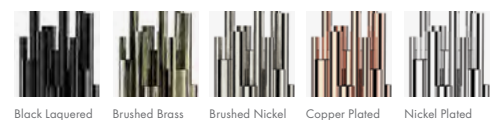
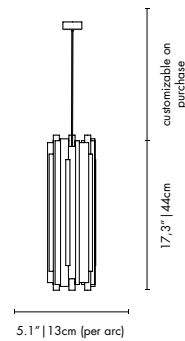

# BRUBECK CHANDELIER | SUSPENSION

MATERIALS  
BODY: Brass

DIMENSIONS  
HEIGHT: 72.05" | 183 cm  
DIAM: 59.06" | 150 cm  
POLE HEIGHT: Customizable on purchase

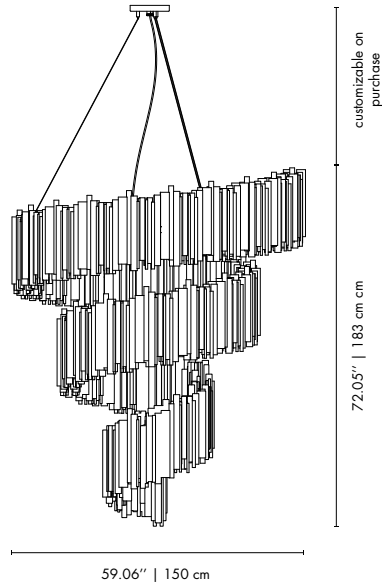

Gold Plated

# CANNONBAL | SUSPENSION

MATERIALS  
BODY: Brass  
SHADE: Brass

WEIGHT  
Approx.: 18 kg | 39.6 lbs

BULBS  
48 x G4 LED / 3W Bulbs (included) (bulbs not included for North America)

DIMENSIONS  
DIAM: 51.1" | 130 cm  
STANDARD CORD HEIGHT: 39.4" | 100 cm (customizable on purchase)

PACKAGE  
(Plywood Box)  
Height: 55.12" | 140cm  
Width: 51.57" | 131cm  
Depth: 51.57" | 131cm

2.4025 m<sup>3</sup> / 51kg

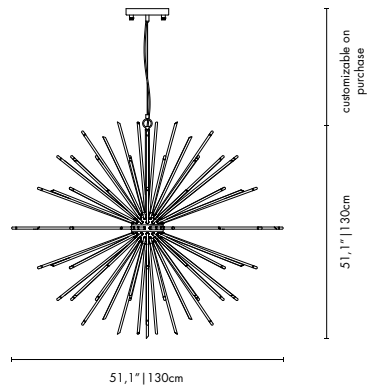

Brass

# CHARLES | SUSPENSION

**MATERIALS**  
 BODY: Brass  
 SHADE: Brass

**WEIGHT**  
 Approx.: 18 kg | 39.6 lbs

**BULBS (40W)**  
 20 x E27 Bulbs (included) (bulbs not included for North America)

**DIMENSIONS**  
 BODY HEIGHT: 15.7" | 40 cm  
 DIAM: 39.3" | 100 cm  
 STANDARD POLE HEIGHT: 35.4" | 90 cm (customizable on purchase)

**PACKAGE**  
 (Cardboard Box)  
 Height: 19.69" | 50cm  
 Width: 47.24" | 120cm  
 Depth: 47.24" | 120cm  
 0.79m<sup>3</sup> / 38kg

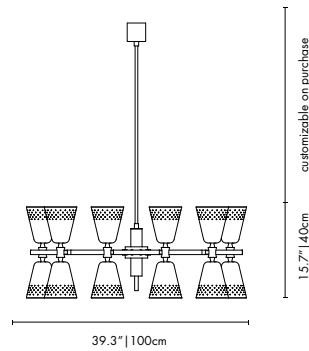

## CHARLES 40 | SUSPENSION

**WEIGHT**  
 Approx.: 28 kg | 61.6 lbs

**BULBS (40W)**  
 40 x E27 Bulbs (included) (bulbs not included for North America)

**DIMENSIONS**  
 HEIGHT: 31.5" | 80 cm  
 DIAM: 39.3" | 100 cm  
 STANDARD POLE HEIGHT: 35.4" | 90 cm (customizable on purchase)

**PACKAGE**  
 (Cardboard Box)  
 Height: 41.34" | 105cm  
 Width: 47.24" | 120cm  
 Depth: 47.24" | 120cm  
 1.512m<sup>3</sup> / 77kg

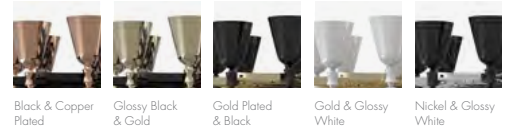

# CLARK | SUSPENSION

**MATERIALS**  
 BODY: Brass

**WEIGHT**  
 Approx.: 7 kg | 15.4 lbs

**BULBS (40W)**  
 10x E14 Tubular Bulbs (included) (bulbs not included for North America)

**DIMENSIONS**  
 HEIGHT: 27.5" | 70 cm  
 DIAM: 19.6" | 50 cm  
 STANDARD POLE HEIGHT: 27.5" | 70 cm (customizable on purchase)

**PACKAGE**  
 (Cardboard Box)  
 Height: 31.5" | 80cm  
 Width: 25.59" | 65cm  
 Depth: 25.59" | 65cm  
 0.338 m<sup>3</sup>/13.5 kg

## CLARK XL | SUSPENSION

**WEIGHT**  
 Approx.: 70 kg | 154.3 lbs

**BULBS (40W)**  
 24x E27 Bulbs (included) (bulbs not included for North America)

**DIMENSIONS**  
 HEIGHT: 110.2" | 280 cm  
 DIAM: 70.9" | 180 cm  
 CORD HEIGHT: 39.4" | 100 cm (adjustable) (customizable on purchase)

**PACKAGE**  
 (Plywood Box)  
 65 x 65 x 80 cm  
 0.338 m<sup>3</sup>/13.5 kg

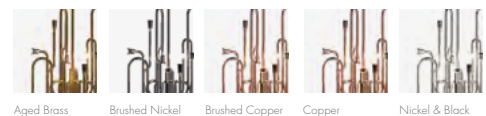
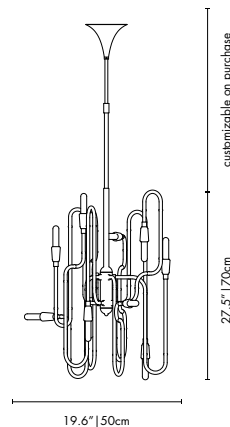

# COLTRANE | SUSPENSION

**MATERIALS**

WIRE: Steel Cords and Magnetic Disc (per tube)  
 CANOPY: Brass  
 SHADE: Steel

**WEIGHT**

Approx.: 5 kg | 11 lbs (per tube)

**BULBS (40W)**

2 x Gu10 (per tube) (included) ) (bulbs not included for North America)

**DIMENSIONS**

TUBE DIAM.: 3.2" | 8 cm  
 WIDTH: 39.4" | 100 cm  
 CORD HEIGHT: 59" | 150 cm (adjustable)  
 (customizable on purchase)

**PACKAGE**

(Cardboard Box)  
 118 x 22 x 22 cm  
 0.0571 m<sup>3</sup> / 5.5 kg

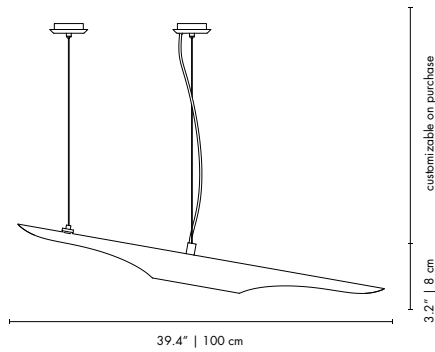

Black Matte & Grey

Gold Plated & White

Nickel Plated & Gold

Nickel Plated & White

White Matte & Gold

# CONNOR | SUSPENSION

**MATERIALS**

**BODY:**

**BULBS**

1 x white LED ribbon  
 1 x G9 LED

**DIMENSIONS**

HEIGHT: 28.35" | 72 cm  
 DIAM: 39.37" | 100 cm

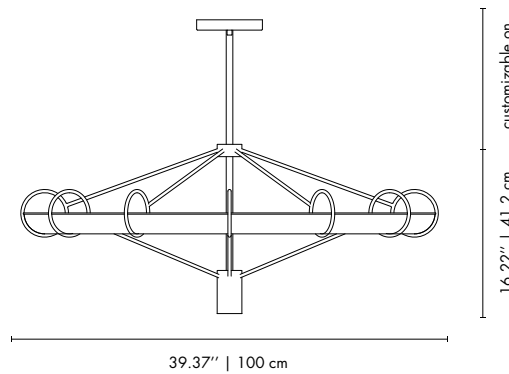

Gold Plated

## COSMO | SUSPENSION

**MATERIALS**  
 BODY: Brass  
 SHADE: Steel

**WEIGHT**  
 Approx.: 24.25 kg | 53.5 lbs

**BULBS (40W)**  
 22x G9 Lamps (included) (bulbs not included for North America)

**DIMENSIONS**  
 TUBE DIAM.: 59.1" | 150 cm  
 HIEGHT: 27.5" | 70 cm  
 CORD HEIGHT: 39.4" | 100 cm (adjustable)  
 (customizable on purchase)

**PACKAGE**  
 (Cardboard Box)  
 165 x 120 x 155 cm  
 3.069 m<sup>3</sup> / 40Kg

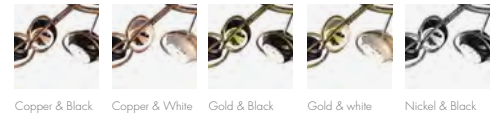
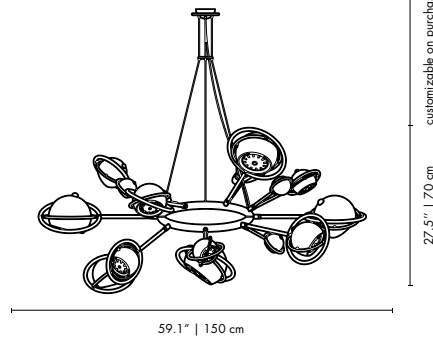

## DIANA | SUSPENSION

**MATERIALS**  
 BODY: Brass  
 SHADE: Aluminium  
 WIRE: Textile

**WEIGHT**  
 Approx.: 5 kg | 11 lbs

**BULBS (40W)**  
 1 x E27 Bulb (included) ) (bulbs not included for North America)

**DIMENSIONS**  
 WIDTH: 11.8" | 30 cm  
 HEIGHT: 19.6" | 50 cm (min) 35.4" | 90 cm (max)  
 LENGTH: 17.7" | 45 cm

**PACKAGE**  
 (Cardboard Box)  
 40 x 40 x 70 cm  
 0.112 m<sup>3</sup> / 8 kg

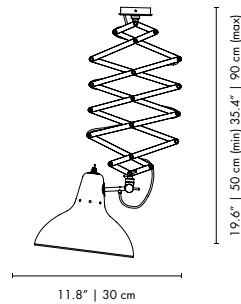

# DORSEY | SUSPENSION

**MATERIALS**  
 BODY: Brass  
 SHADE: Aluminium

**WEIGHT**  
 Approx.: 15 kg | 33 lbs

**BULBS (3W)**  
 40 x E14 Bulb LED / 2700K (included) (bulbs not included for North America)

**DIMENSIONS**  
 WIDTH: 52.36" | 133 cm  
 HEIGHT: 19.7" | 50 cm  
 TELESCOPIC TUBE HEIGHT: 27.6" | 70 cm (adjustable)  
 (customizable on purchase)

**PACKAGE**  
 (Cardboard Box)  
 Height: 23.62" | 60cm  
 Width: 53.15" | 135cm  
 Depth: 53.15" | 135cm  
 1.09m<sup>3</sup> / 20 kg

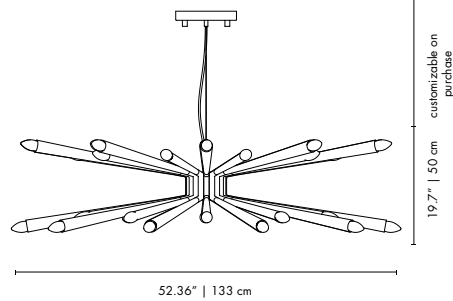

# DUKE | SUSPENSION

**MATERIALS**  
 BODY: Brass  
 SHADE: Aluminium  
 WIRE: Textile

**WEIGHT**  
 Approx.: 9 kg | 19.8 lbs (3 arms)

**BULBS (40W)**  
 18 x G9 Bulbs (included) (bulbs not included for North America)

**DIMENSIONS**  
 HEIGHT: 13.8" | 35 cm  
 WIDTH: 66" | 168 cm  
 CORD HEIGHT: 25.6" | 65 cm (adjustable)  
 (customizable on purchase)  
 Cable height between arms: 11.81" | 30cm

**PACKAGE**  
 (Cardboard Box)  
 Height: 66.93" | 170cm  
 Width: 27.56" | 70cm  
 Depth: 23.62" | 60cm  
 0.714 m<sup>3</sup> / 21.5 kg

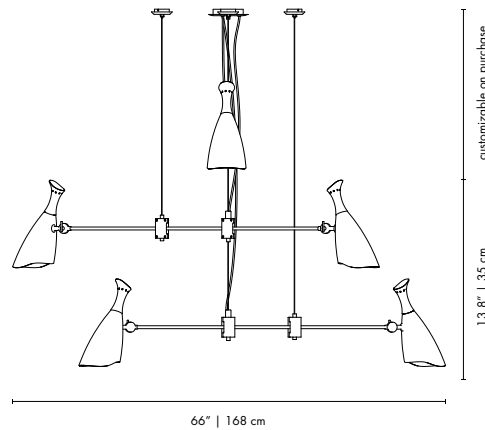

## DUKE 12 | SUSPENSION

**WEIGHT**  
 Approx.: 30 kg | 26.4 lbs

**BULBS (40W)**  
 36 x G9 Bulbs (included) (bulbs not included for North America)

**DIMENSIONS**  
 BODY HEIGHT: 13.8" | 35 cm  
 DIAM.: 66" | 168 cm  
 POLE HEIGHT: 39.4" | 100 cm  
 (adjustable)  
 (customizable on purchase)

**PACKAGE**  
 (Cardboard Box)  
 Height: 21.65" | 55cm  
 Width: 68.9" | 175cm  
 Depth: 68.9" | 175cm  
 1.684 m<sup>3</sup> / 45 kg



Gold & Black    Copper & Black    Copper & White    Gold & White    Nickel & Black

## ELLA | SUSPENSION

**MATERIALS**  
 BODY: Brass  
 SHADE: Aluminum

**WEIGHT**  
 Approx.: 8 kg | 17.6 lbs

**BULBS (40W)**  
 6 x G9 Bulbs (included) (bulbs not included for North America)

**DIMENSIONS**  
 HEIGHT: 21.3" | 54 cm  
 DIAM.: 30" | 76 cm  
 STANDARD POLE HEIGHT: 39.4" | 100 cm (adjustable)  
 (customizable on purchase)

**PACKAGE**  
 (Cardboard Box)  
 Height: 25.59" | 65cm  
 Width: 33.46" | 85cm  
 Depth: 33.46" | 85cm  
 0.4696m³/13 kg

### ELLA 15 | SUSPENSION

**WEIGHT**  
 Approx.: 16 kg | 35.3 lbs

**BULBS (40W)**  
 15 x G9 Bulbs (included) (bulbs not included for North America)

**DIMENSIONS**  
 HEIGHT: 22.8" | 58 cm  
 DIAM.: 50.4" | 128 cm  
 POLE HEIGHT: 39.4" | 100 cm  
 (adjustable)  
 (customizable on purchase)

**PACKAGE**  
 (Cardboard Box)  
 Height: 27.56" | 70cm  
 Width: 57.09" | 145cm  
 Depth: 61.02" | 155cm  
 1.5732 m³ / 36 kg

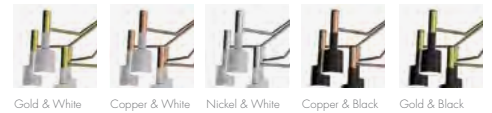
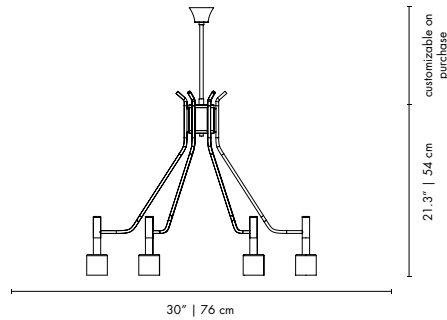

## ETTA ROUND | SUSPENSION

**MATERIALS**  
 BODY: Brass

**WEIGHT**  
 Approx.: 40 kg | 88 lbs

**BULBS (40 w)**  
 24 x G9 Bulbs (included) (bulbs not included for North America)

**DIMENSIONS**  
 BODY HEIGHT: 15.6" | 39 cm  
 DIAM.: 39.4" | 100 cm  
 STANDARD CORD HEIGHT: 39.4" | 100 cm (adjustable)  
 (customizable on purchase)

**PACKAGE**  
 Height: 22.83" | 58cm  
 Width: 34.65" | 108cm  
 Depth: 34.65" | 108cm  
 0.68 m³ / 73 kg

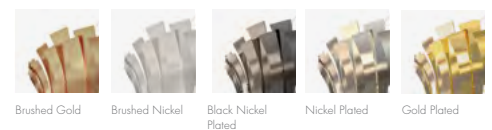
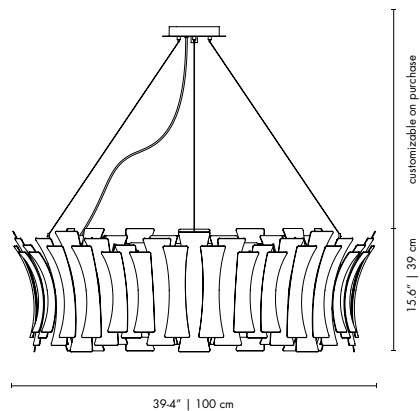



## ETTA CHANDELIER | SUSPENSION

**MATERIALS**  
BODY: Brass

**WEIGHT**  
Approx.: 95 kg | 209 lbs

**BULBS (40W)**  
42 x G9 Bulbs (included) (bulbs not included for North America)

**DIMENSIONS**  
TOTAL BODY HEIGHT: 50" | 127 cm  
DIAM: 45.3" | 115 cm  
STANDARD CORD HEIGHT: 39.4" | 100 cm  
(adjustable) (customizable on purchase)

**PACKAGE**  
(Plywood Boxes)  
Vol.1  
Height: 21.26" | 54cm  
Width: 46.06" | 117cm  
Depth: 47.24" | 120cm

Vol.2  
Height: 21.26" | 54cm  
Width: 38.58" | 98cm  
Depth: 37.4" | 95cm  
0.75 + 0.5 m<sup>3</sup> / 47 + 55 kg

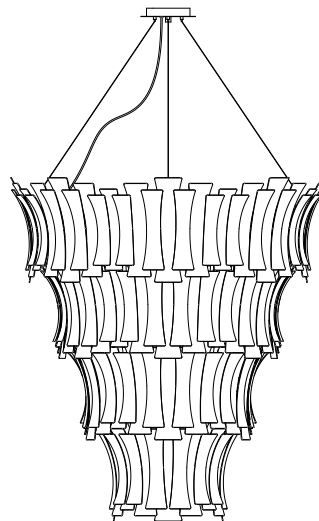

customizable on purchase

50" | 127 cm

45.3" | 115 cm



Gold Plated

## ETTA PENDANT | SUSPENSION

**MATERIALS**  
BODY: Brass

**WEIGHT**  
Approx.: 9.5 kg | 20.9 lbs

**BULBS (40W)**  
4 x G9 Bulbs (included) (bulbs not included for North America)

**DIMENSIONS**  
BODY HEIGHT: 23.6" | 60 cm  
DIAM: 11.8" | 30 cm  
CORD HEIGHT: 39.4" | 100 cm (adjustable)  
(customizable on purchase)

**PACKAGE**  
(Cardboard Box)  
Height: 29.53" | 75cm  
Width: 17.72" | 45cm  
Depth: 17.72" | 45cm  
0.1519 m<sup>3</sup> / 15,6 kg

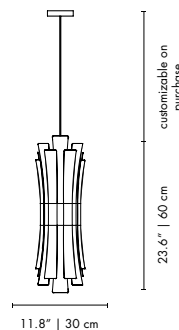

customizable on purchase

23.6" | 60 cm

11.8" | 30 cm



Brushed Gold



Brushed Nickel



Black Nickel Plated



Nickel Plated



Gold Plated

## GALLIANO ROUND | SUSPENSION

**MATERIALS**  
 BODY: Steel

**WEIGHT**  
 Approx.: 60 kg | 132 lbs

**BULBS (40W)**  
 70 x G9 Bulbs (included) (bulbs not included for North America)

**DIMENSIONS**  
 BODY HEIGHT: 15.7" | 40 cm  
 DIAM.: 31.5" | 80 cm  
 CORD HEIGHT: 39.4" | 100 cm  
 (adjustable)  
 (customizable on purchase)

**PACKAGE**  
 (Plywood Box)  
 Height: 25.59" | 65cm  
 Width: 43.31" | 110cm  
 Depth: 43.31" | 110cm  
 0.67 m<sup>3</sup> / 88 KG

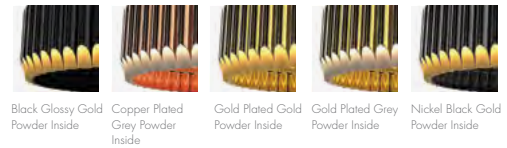
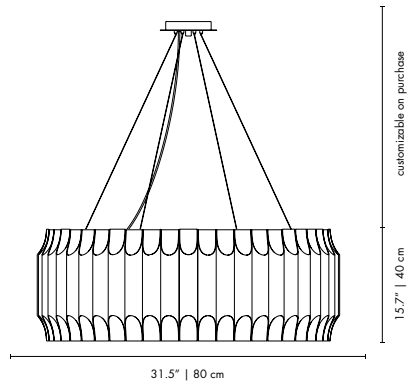

## GALLIANO PENDANT | SUSPENSION

**MATERIALS**  
 BODY: Steel

**WEIGHT**  
 Approx.: 3 kg | 6.6 lbs

**BULBS (40W)**  
 6x E27 Bulbs (included) (bulbs not included for North America)

**DIMENSIONS**  
 HEIGHT: 20.5" | 52 cm  
 DIAM.: 6.3" | 16 cm  
 POLE HEIGHT: 39.4" | 100 cm (adjustable)  
 (customizable on purchase)

**PACKAGE**  
 (Cardboard Box)  
 Height: 23.62" | 60cm  
 Width: 11.81" | 30cm  
 Depth: 8.66" | 22cm  
 0.0396 m<sup>3</sup> / 5.2 Kg

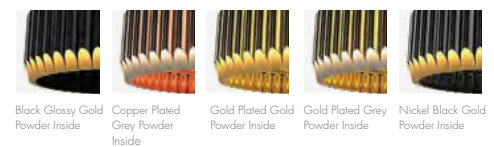
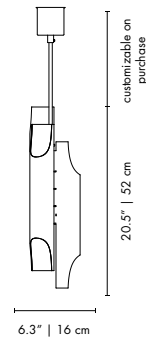

# HANK | SUSPENSION

**MATERIALS**

BODY: Brass  
 SHADES: Aluminum and Brass

**BULBS (40W)**

20 x E14 Bulbs (2 per shade - included) (bulbs not included for North America)

**DIMENSIONS**

DIAM.: 55.1" | 140 cm  
 HEIGHT: 36.2" | 92 cm  
 TELESCOPIC TUBE HEIGHT: 27.5" | 70 cm  
 (customizable on purchase)

**PACKAGE**

(Plywood Box)

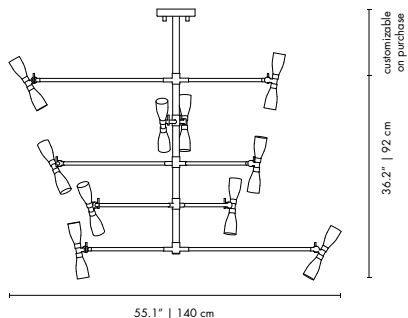

Gold Plated  
 Black Matte

# HANNA | SUSPENSION

**MATERIALS**

BODY: Brass  
 SHADES: Aluminum and Brass

**WEIGHT**

Approx.: 67 kg | 147 lbs

**BULBS (40W)**

25 x E27 Bulbs (1 per shade - included) (bulbs not included for North America)

**DIMENSIONS**

DIAM.: 39.4" | 100 cm  
 HEIGHT: 35.4" | 90 cm  
 CORD HEIGHT: 43.3" | 110 cm  
 (customizable on purchase)

**PACKAGE**

(Cardboard Box)  
 53 x 106 x 106 cm  
 0.60 m<sup>3</sup>/ 67 kg

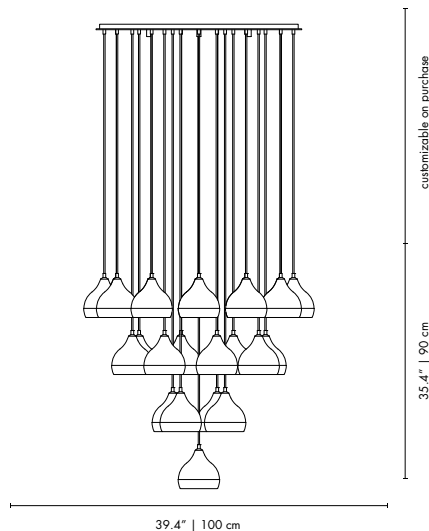

Black & Copper    White & Copper    Black & Gold    Nickel & Black    White & Nickel

## HANNA PENDANT | SUSPENSION

**MATERIALS**  
 BODY: Brass  
 SHADES: Aluminum and Brass

**WEIGHT**  
 Approx.: 18 kg | 39.6 lbs

**BULBS (40W)**  
 5x E27 Bulbs (included) (bulbs not included for North America)

**DIMENSIONS**  
 Maximum Open DIAM: 19.7" | 50 cm  
 HEIGHT: 47.2" | 120 cm  
 (customizable on purchase)

**PACKAGE**  
 (Cardboard Box)  
 Height: 48.03" | 122cm  
 Width: 27.56" | 70cm  
 Depth: 23.62" | 60cm  
 0.5124 m³ / 21 kg

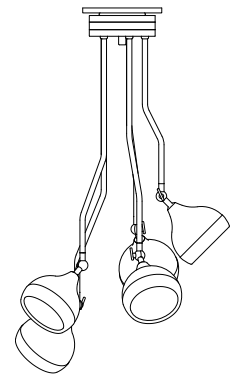

Max Open Diam.  
19.7" | 50 cm

customizable on purchase

47.2" | 120 cm



Black & Copper

White & Copper

Black & Gold

Nickel & Black

White & Nickel

## HENDRIX | SUSPENSION

**MATERIALS**  
 BODY: Brass  
 SHADES: Brass

**WEIGHT**  
 Approx. 20 kg | 44 lbs

**BULBS (40W)**  
 9 x G9 Bulbs (included) (bulbs not included for North America)

**DIMENSIONS**  
 DIAM.: 65" | 165 cm  
 HEIGHT: 13.8" | 35 cm  
 POLE HEIGHT: 39.4" | 100 cm  
 (customizable on purchase)

**PACKAGE**  
 (Cardboard Box)

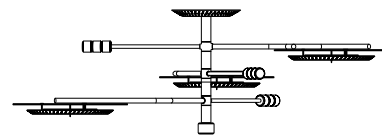

65" | 165 cm

13.8" | 35 cm



Black & Copper

White & Copper

White & Gold

Nickel & Black

White & Nickel

# HENDRIX CHANDELIER | SUSPENSION

**MATERIALS**  
 BODY: Brass

**WEIGHT**  
 Approx.: 35 Kg | 77 lbs

**BULBS (40W)**  
 15 x G9 Bulbs (bulbs not included for North America)

**DIMENSIONS**  
 BODY HEIGHT: 19.7" | 50 cm  
 DIAM.: 27.2 | 69 cm  
 STANDARD CORD HEIGHT: 39.4 | 100 cm (customizable on purchase)

**PACKAGE**  
 (Cardboard Box)  
 Height: 31.5" | 80cm  
 Width: 57.09" | 145cm  
 Depth: 61.02" | 155cm  
 1.798 m<sup>3</sup> / 50 Kg

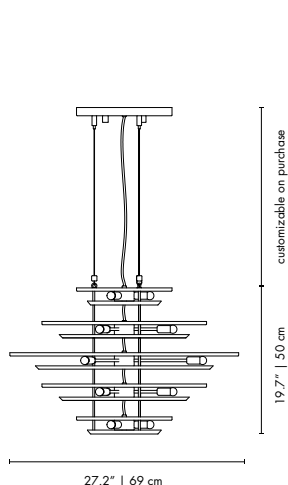

# IKE | SUSPENSION

**MATERIALS**  
 BODY: Brass  
 SHADES: Brass and Aluminum

**WEIGHT**  
 Approx.: 9.5 kg | 21 lbs

**BULBS (40W)**  
 13 x G9 Bulbs (included) (bulbs not included for North America)

**DIMENSIONS**  
 BODY HEIGHT: 15" | 38 cm  
 DIAM.: 23.6" | 60 cm  
 CORD HEIGHT: 39.4" | 100 cm (adjustable)  
 (customizable on purchase)

**PACKAGE**  
 (Cardboard Box)  
 Height: 18.11" | 46cm  
 Width: 29.53" | 75cm  
 Depth: 29.53" | 75cm  
 0.2587 m<sup>3</sup> / 17 kg

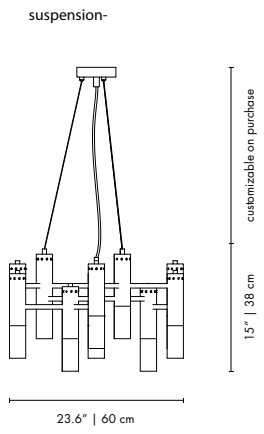

## JACKSON | SUSPENSION

BODY: Brass  
 SHADES: Aluminum and Brass  
 WIRE: Textile

WEIGHT  
 Approx. 15 kg | 33 lbs

BULBS (40W)  
 6 x Gu10 Bulbs (included) (for USA not included)

DIMENSIONS  
 HEIGHT: 11.8" | 30 cm  
 DIAMETER: 39.3" | 100 cm  
 TELESCOPIC TUBE: 11.8" - 23.6" | 30 - 60 cm  
 TELESCOPIC TUBE HEIGHT: 27.5" | 70 cm  
 (customizable on purchase)

PACKAGE  
 (Cardboard Box)  
 96 x 96 x 46 cm  
 0.4239 m<sup>3</sup> / 21 kg

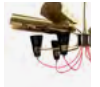
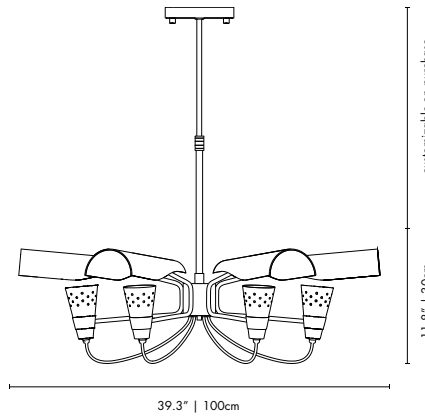

Black Matte & Gold Plated

## KRAVITZ | SUSPENSION

MATERIALS  
 BODY: Aluminum

WEIGHT  
 Approx. 50 kg | 110 lbs

BULBS (1W)  
 86 x CREE LED

DIMENSIONS  
 HEIGHT: 25.6" | 65cm  
 DIAMETER: 24.4" | 62 cm  
 CORD HEIGHT: 39.4" | 100 cm (adjustable)  
 (customizable on purchase)

PACKAGE  
 (Plywood Box)  
 95 x 85 x 85 cm  
 0.686 m<sup>3</sup> / 80 kg

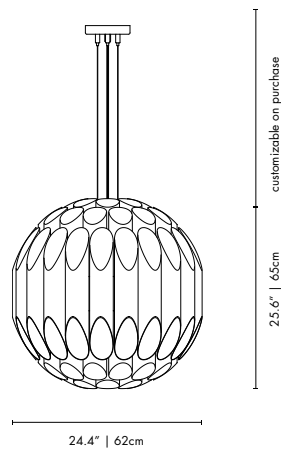

Gold & White Powder Inside

# LAINÉ | SUSPENSION

MATERIALS  
BODY: Brass  
SHADE: Aluminum

BULBS (40W)  
6 x E14 Bulbs LED (included) (for USA not included)

DIMENSIONS  
LENGTH: 68.9" | 175 cm  
WITH: 68.9" | 175 cm  
HEIGHT: 15.3" | 39 cm

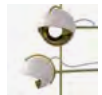
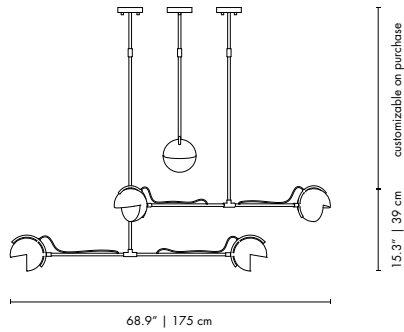

Glossy White & Gold Plated

# MADELEINE | SUSPENSION

MATERIALS  
BODY: Brass  
SHADE: Aluminum

WEIGHT  
Approx. 3.3 kg | 7.2 lbs

BULBS (40W)  
4 x E27 Bulbs (included) (E26 for USA not included)

DIMENSIONS  
DIAM.: 16" | 40 cm  
HEIGHT: 15.5" | 39 cm  
POLE HEIGHT: 39.4" | 100 cm (adjustable)  
(customizable on purchase)

PACKAGE  
(Cardboard Box)  
61 x 61 x 42 cm  
0.1563 m<sup>3</sup> / 10 kg

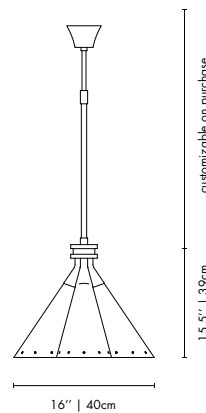

Copper & Black



Copper & White



Gold & Black



Nickel & Black



Nickel & White

# MATHENY | SUSPENSION

**MATERIALS**  
BODY: Brass

**WEIGHT**  
Approx. 50 kg | 110 lbs

**BULBS (40W)**  
24 x G9 Bulbs (included) (for USA not included)

**DIMENSIONS**  
DIAM.: 39.4" | 100 cm  
HEIGHT: 11.8" | 30 cm  
CORD HEIGHT: 39.4" | 100 cm (adjustable)  
(customizable on purchase)

**PACKAGE**  
(Plywood Box)  
120 x 120 x 40 cm  
0.576 m<sup>3</sup> / 68kg

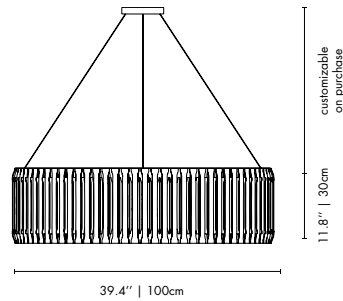

Aged Brass    Black Laquered    Brushed Nickel    Copper Plated    Nickel Plated

# MATHENY PENDANT | SUSPENSION

**MATERIALS**  
BODY: Brass

**WEIGHT**  
Approx. 4 kg | 8.8 lbs

**BULBS (40W)**  
6 x G9 Bulbs (included) (for USA not included)

**DIMENSIONS**  
DIAM.: 7" | 18 cm  
HEIGHT: 11.8" | 30 cm  
CORD HEIGHT: 39.4" | 100 cm (adjustable)  
(customizable on purchase)

**PACKAGE**  
(Cardboard Box)  
28 x 28 x 40 cm  
0.031 m<sup>3</sup>

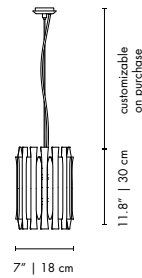

Aged Brass    Black Laquered    Brushed Nickel    Copper Plated    Nickel Plated



# NEIL | SUSPENSION

MATERIALS  
 BODY: Brass  
 SHADE: Steel

WEIGHT  
 Approx. 15 kg | 33 lbs

BULBS (40W)  
 8 x E27 Bulbs (included) (E26 for USA not included)

DIMENSIONS  
 DIAM.: 47.3" | 120 cm  
 HEIGHT: 23.6" | 60 cm  
 POLE HEIGHT: 7.9" - 23.6" | 20 - 60 cm (adjustable)  
 (customizable on purchase)

PACKAGE  
 (Cardboard Box)  
 140 x 140 x 40 cm  
 0.78 m<sup>3</sup> / 29 kg

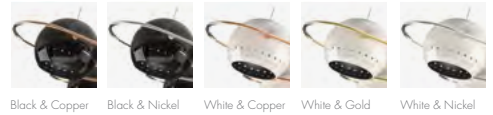
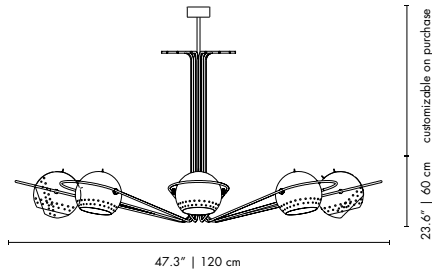

# NORAH | SUSPENSION

MATERIALS  
 BODY: Brass  
 BULB HOLDER: Aluminum

WEIGHT  
 Approx.: 5.8 kg | 12.8 lbs

BULBS (40W)  
 17 x E14 Bulbs (included) (E12 for USA not included)

DIMENSIONS  
 HEIGHT: 7.9" | 20 cm  
 DIAM.: 38.2" | 97 cm  
 POLE HEIGHT: 27.5" | 70 cm  
 (customizable on purchase)

PACKAGE  
 (Cardboard Box)  
 110 x 110 x 40 cm  
 0.484 m<sup>3</sup> / 20 kg

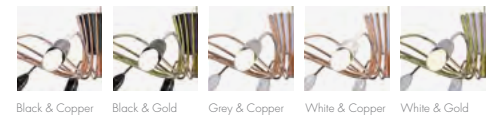
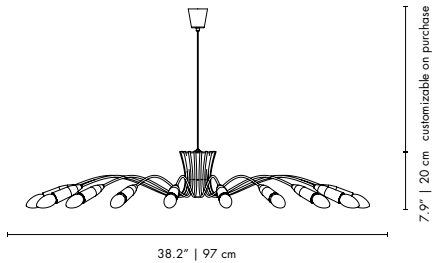

## PEGGY | SUSPENSION

**MATERIALS**

BODY: Brass and Wood  
 SHADE: Aluminum  
 TOP COVER: Steel

**WEIGHT**

Approx.: 8 kg | 17.6 lbs

**BULBS (40W)**

8 x E14 Reflector Bulbs (included) (E12 for USA not included)

**DIMENSIONS**

HEIGHT: 20" | 51 cm  
 DIAM.: 41.3" | 105 cm  
 POLE HEIGHT: 39.4" | 100 cm  
 (customizable on purchase)

**PACKAGE**

(Cardboard Box)  
 106 x 106 x 57 cm  
 0.6405 m<sup>3</sup> / 23,4kg

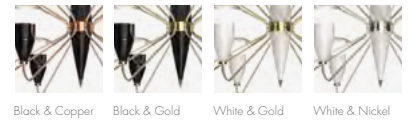
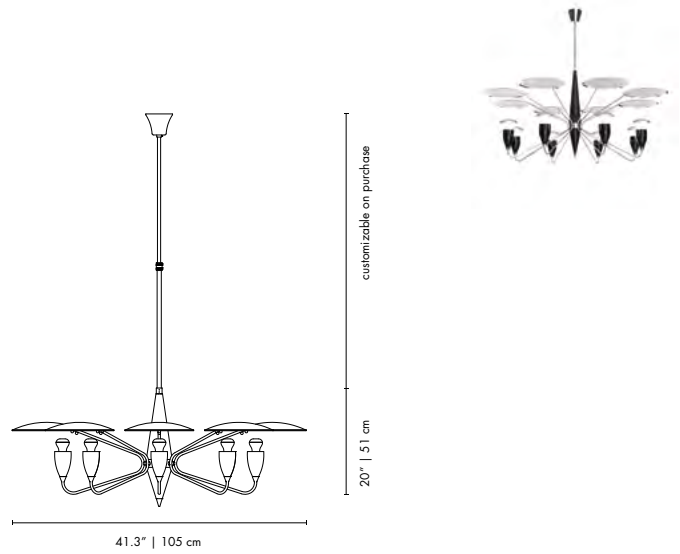

## SIMONE | SUSPENSION

**MATERIALS**

BODY: Brass and Wood  
 SHADE: Aluminum  
 WIRE: Textile

**WEIGHT**

Approx. 7 kg | 15.4 lbs

**BULBS (40W)**

3 x E27 Bulbs (included) (bulbs not included for North America)

**DIMENSIONS**

BODY HEIGHT: 35.4" | 90 cm  
 DIAM.: 43.3" | 110 cm  
 STANDARD POLE HEIGHT: 19.7" | 50 cm  
 (customizable on purchase)

**PACKAGE**

(Cardboard Box)  
 Height: 37.8" | 96cm  
 Width: 39.37" | 100cm  
 Depth: 39.37" | 100cm  
 1.1616 m<sup>3</sup> / 25 kg

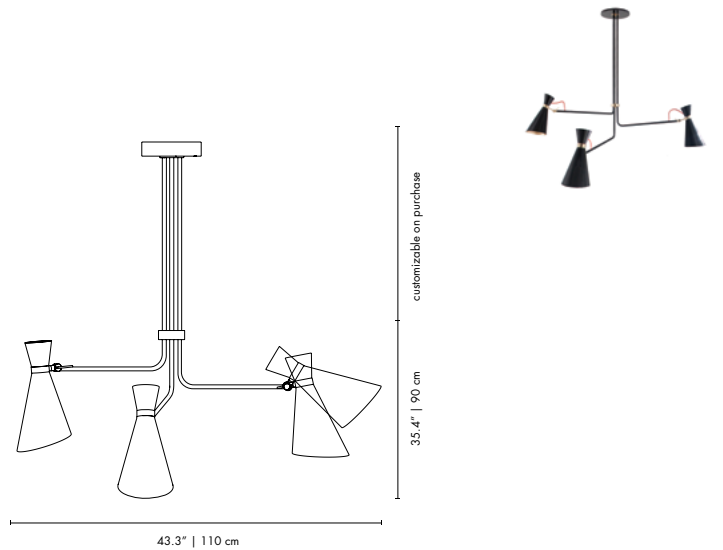

# SINATRA | SUSPENSION

**MATERIALS**  
 BODY: Brass  
 SHADE: Aluminum  
 COUNTER WEIGHT: Steel

**WEIGHT**  
 Approx. 15 kg | 33 lbs

**BULBS (40W)**  
 3 x E27 Bulbs (included) (bulbs not included for North America)

**DIMENSIONS**  
 TOTAL CENTRAL ROD HEIGHT  
 (from the bottom to the connection with adjustable point): 23.62" | 60 cm  
 ADJUSTABLE POLE HEIGHT: (customizable on purchase)  
 Maximum Open DIAM: 43.3" | 110 cm

**PACKAGE**  
 (Cardboard Box)  
 Height: 51.18" | 130cm  
 Width: 23.62" | 60cm  
 Depth: 27.56" | 70cm  
 0.546 m<sup>3</sup> / 20 kg

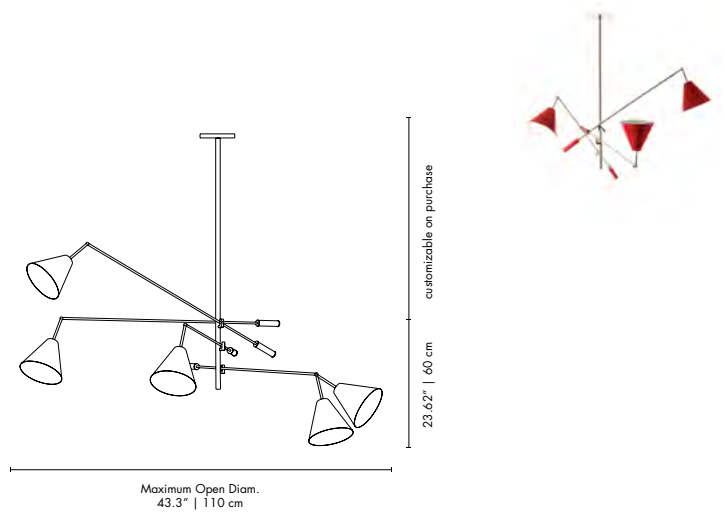

# STANLEY | SUSPENSION

**MATERIALS**  
 BODY: Brass  
 SHADE: Aluminum  
 COUNTER WEIGHT: Steel

**WEIGHT**  
 Approx. 15 kg | 33 lbs

**BULBS (40W)**  
 3 x E27 Bulbs (included) (bulbs not included for North America)

**DIMENSIONS**  
 TOTAL CENTRAL ROD HEIGHT  
 (from the bottom to the connection with adjustable point): 23.62" | 60 cm  
 ADJUSTABLE POLE HEIGHT: (customizable on purchase)  
 Maximum Open DIAM: 43.3" | 110 cm

**PACKAGE**  
 (Cardboard Box)  
 Height: 51.18" | 130cm  
 Width: 39.37" | 100cm  
 Depth: 25.59" | 65cm  
 0.845 m<sup>3</sup> / 26.3

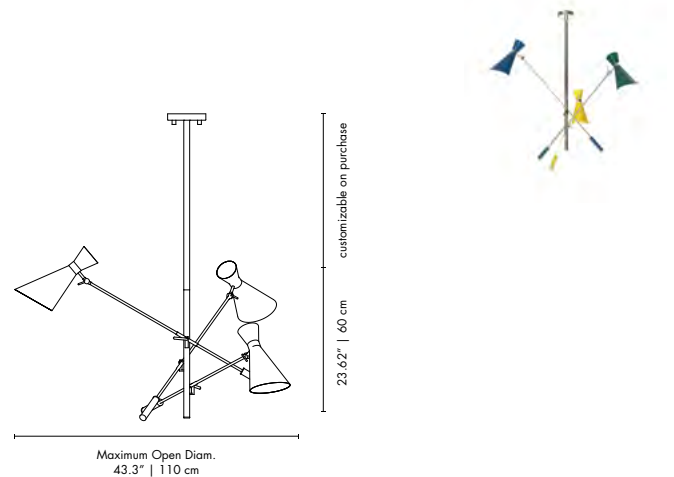

# TURNER | SUSPENSION

**MATERIALS**  
 BODY: Brass  
 SHADE: Aluminum

**WEIGHT**  
 Approx. 3.5 kg | 7.7 lbs

**BULBS (40W)**  
 1 x E27 Bulbs (included) (bulbs not included for North America)

**DIMENSIONS**  
 HEIGHT (Body): 26.7" | 68 cm  
 WIDTH: 11.8" | 30 cm  
 LENGTH: 11.8" | 30 cm  
 CORD HEIGHT: Adjustable

**PACKAGE**  
 (Cardboard Box)  
 Height: 32.68" | 83cm  
 Width: 12.99" | 33cm  
 Depth: 12.99" | 33cm  
 0.090 m<sup>2</sup> / 5.6

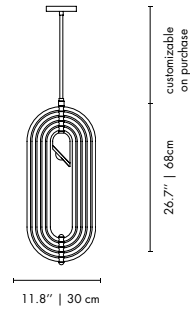



**FLOOR  
LAMPS**

## AMY | FLOOR

**MATERIALS**

BODY: Brass and Steel  
 SHADE: Aluminum

**WEIGHT**

Approx.: 6.5 kg | 14.3 lbs

**BULBS (40W)**

2 x E14 Bulbs (included) (bulbs not included for North America)

**DIMENSIONS**

WIDTH: 11.8" | 30 cm  
 HEIGHT: 59" | 150 cm  
 DEPTH: 15.7" | 40 cm

**PACKAGE**

(Cardboard Box)  
 WIDTH: 18.1" | 46 cm  
 HEIGHT: 62.9" | 160 cm  
 DEPTH: 18.1" | 46 cm  
 0,3386 m³/11,5 kg

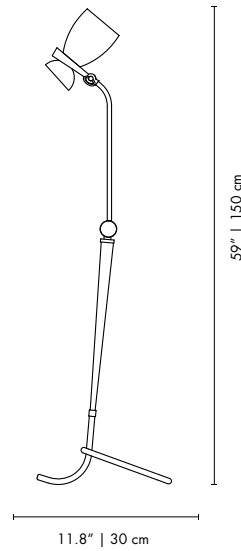

Copper & Black    Copper & White    Gold & White    Black & Nickel    White & Nickel

## ARMSTRONG | FLOOR

**MATERIALS**

BODY: Brass  
 SHADE: Aluminium  
 BASE: Carrara Marble (Polished)  
 COUNTERWEIGHT: Steel

**WEIGHT**

Approx.: 13.5 kg | 29.8 lbs

**BULBS (40W)**

4 x G9 Bulbs (included) (bulbs not included for North America)

**DIMENSIONS**

WIDTH: 47.2" | 120 cm  
 HEIGHT: 59.1" | 150 cm  
 DEPTH: 13.8" | 35 cm

**PACKAGE**

(Cardboard Box)  
 WIDTH: 26.7" | 68cm  
 HEIGHT: 65" | 165cm  
 DEPTH: 23.2" | 59 cm  
 0.662 m³ / 23kg

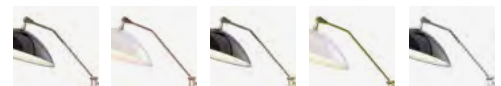
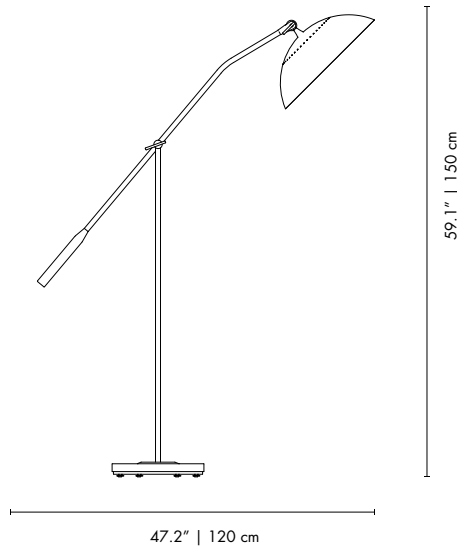

Copper & Black    Copper & White    Gold & Black    Gold & White    Nickel & Black

# BOTTI | FLOOR

**MATERIALS**  
BODY: Brass  
SHADE: Brass

**WEIGHT**  
Approx.: 18 kg | 39.7 lbs

**BULBS (40W)**  
8 x E14 Reflector Bulbs (included) (bulbs not included for North America)

**DIMENSIONS**  
HEIGHT: 70.9" | 180 cm  
DEPTH: 24.8" | 63 cm

**PACKAGE**  
(Cardboard Box)  
WIDTH: 29.5" | 75 cm  
HEIGHT: 74.8" | 190 cm  
DEPTH: 29.5" | 75 cm  
1.0687 m<sup>3</sup> / 34.3 kg

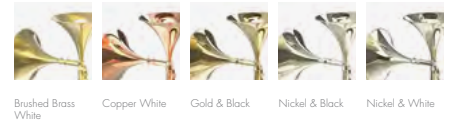
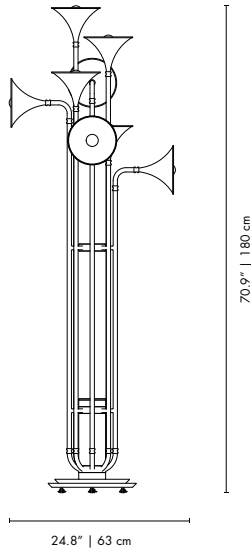

# BRUBECK | FLOOR

**MATERIALS**  
BODY: Brass  
BASE: Steel

**WEIGHT**  
Approx.: 22 kg | 48.5 lbs

**BULBS (40W)**  
6 x E27 Bulbs (included) (bulbs not included for North America)

**DIMENSIONS**  
HEIGHT: 65.7" | 167 cm  
DEPTH: 13" | 33 cm

**PACKAGE**  
(Cardboard Box)  
WIDTH: 18.5" | 47 cm  
HEIGHT: 72.8" | 185 cm  
DEPTH: 18.5" | 47 cm  
0.3382 m<sup>3</sup> / 37.5 kg

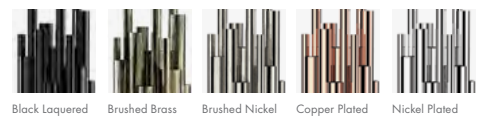
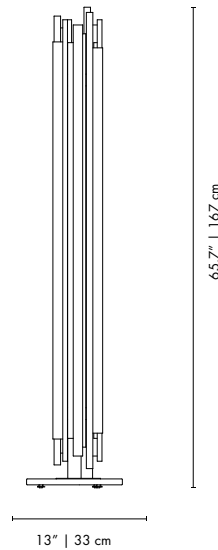

## COLE | FLOOR

**MATERIALS**  
 BODY: Brass  
 SHADE: Aluminum

**WEIGHT**  
 Approx.: 13 kg | 28.7 lbs

**BULBS (40W)**  
 3 x E27 Bulbs (included) (bulbs not included for North America)

**DIMENSIONS**  
 WIDTH: 17.7" | 45 cm  
 HEIGHT: 76" | 193 cm  
 DEPTH: 13.8" | 35 cm

**PACKAGE**  
 (Cardboard Box)  
 WIDTH: 27.1" | 69  
 HEIGHT: 79.1" | 201 cm  
 DEPTH: 22.8" | 58 cm  
 0.8044 m<sup>3</sup> / 25kg

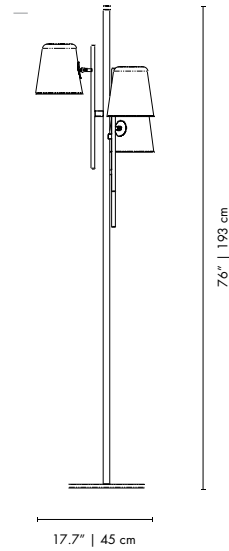

## COLEMAN | FLOOR

**MATERIALS**  
 BODY: Brass  
 SHADE: Aluminum  
 WIRE: Textile

**WEIGHT**  
 Approx.: 5 kg | 11 lbs

**BULBS (40W)**  
 1 x E27 Bulbs (included) (bulbs not included for North America)

**DIMENSIONS**  
 HEIGHT: 70.5" | 179 cm  
 DEPTH :18" | 45 cm

**PACKAGE**  
 (Cardboard Box)  
 WIDTH: 18.1" | 46 cm  
 HEIGHT: 74.8" | 190 cm  
 DEPTH: 18.1" | 46 cm  
 0.4 m<sup>3</sup> / 15kg

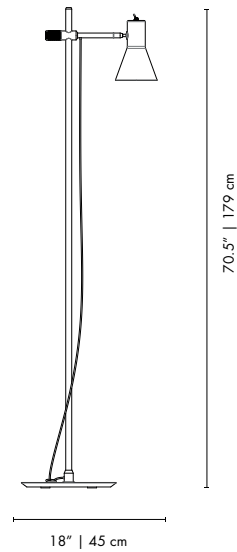



# COLTRANE | FLOOR

**MATERIALS**  
 BODY: Brass and Aluminum  
 SHADE: Steel

**WEIGHT**  
 Approx.: 15 kg | 33 lbs

**BULBS (40W)**  
 6 x Gu10 Bulbs (included) (bulbs not included for North America)

**DIMENSIONS**  
 HEIGHT: 68.9" | 175 cm  
 DIAM.: 11.8" | 30 cm

**PACKAGE**  
 (Cardboard Box)  
 WIDTH: 18.1" | 46 cm  
 HEIGHT: 78.7" | 200 cm  
 DEPTH: 18.1" | 46 cm  
 0.4232 m<sup>3</sup> / 26 kg

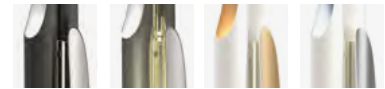
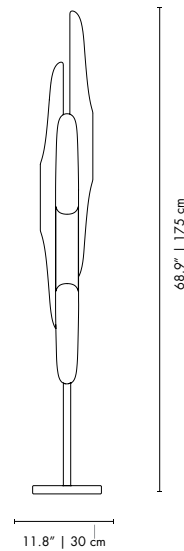

Black & Grey    Gold & White    White & Gold    White & Grey

# DIANA XL | FLOOR

**MATERIALS**  
 BODY: Steel  
 SHADE: Aluminum

**WEIGHT**  
 Approx.: 45 kg | 39.7 lbs

**BULBS (40W)**  
 1 x E27 Bulb (included) (bulbs not included for North America)

**DIMENSIONS**  
 WIDTH: 51.2" | 130 cm  
 HEIGHT: 90.5" | 230 cm  
 DEPTH: 59" | 150 cm

**PACKAGE**  
 (Cardboard Boxes)  
 Vol.1:  
 WIDTH: 47.2" | 120 cm  
 HEIGHT: 47.2" | 120 cm  
 DEPTH: 17.7" | 45 cm

Vol.2:  
 WIDTH: 29.5" | 75 cm  
 HEIGHT: 29.5" | 75 cm  
 DEPTH: 24.4" | 62 cm  
 0.65 + 0.35 m<sup>3</sup> / 61 kg

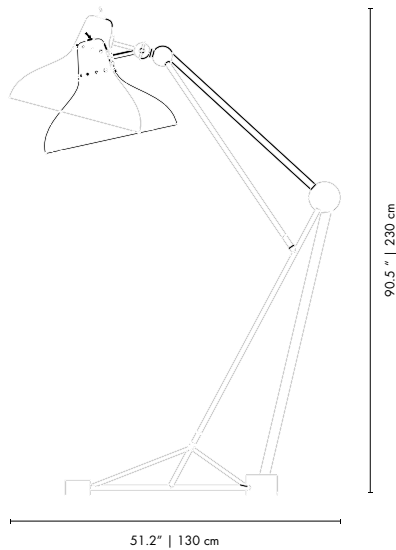

Nickel & Blue    Gold & Blue    Gold & Red    Gold & White    Nickel & White

## DUKE | FLOOR

**MATERIALS**  
 BODY: Brass  
 SHADE: Aluminum and Brass  
 WIRE: Textile

**WEIGHT**  
 Approx.: 18 kg | 39.68 lbs

**BULBS (40W)**  
 9x G9 Bulbs (included) (bulbs not included for North America)

**DIMENSIONS**  
 HEIGHT: 63.7" | 162 cm  
 BASE DIAM.: 13.8" | 35 cm

**PACKAGE**  
 (Cardboard Box)  
 WIDTH: 27.5" | 70 cm  
 HEIGHT: 64.9" | 165 cm  
 DEPTH: 23.6" | 60 cm  
 0.693 m³ / 29 kg

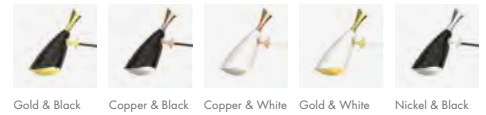
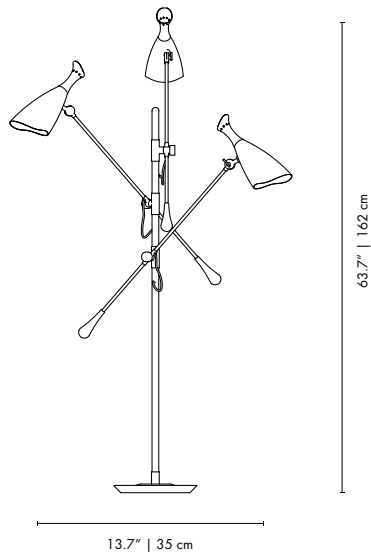

## EVANS | FLOOR

**MATERIALS**  
 BODY: Brass  
 SHADE: Aluminum  
 WIRE: Textile

**WEIGHT**  
 Approx.: 8 kg | 17.6 lbs

**BULBS (40W)**  
 3 x E27 Bulbs (included) (bulbs not included for North America)

**DIMENSIONS**  
 HEIGHT: 74" | 190 cm  
 DIAM.: 25.6" | 65 cm

**PACKAGE**  
 Width: 27.6" | 70 cm  
 Height: 77.2" | 196 cm  
 DEPTH: 23.6" | 60 cm  
 (Cardboard Box)  
 0.8232 m³ / 21.5 kg

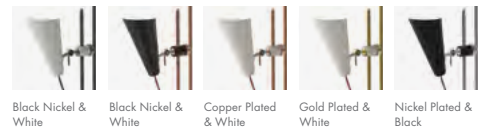
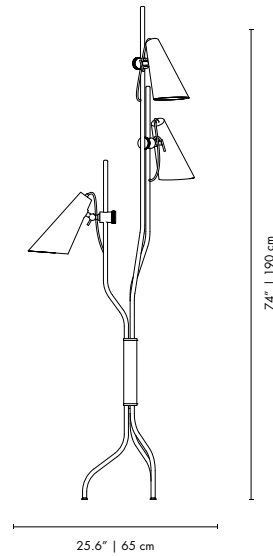

# HANNA | FLOOR

MATERIALS  
BODY: Brass  
SHADE: Brass and Aluminum  
BASE: Marble Estremoz (Polished)

WEIGHT  
Approx.: 34 kg | 75 lbs

BULBS (40W)  
5 x E27 Bulbs (included) (bulbs not included for North America)

DIMENSIONS  
HEIGHT: 66.9" | 170 cm  
MAX DIAM.: 31.5" | 80 cm

PACKAGE  
(Cardboard Box)  
Vol.1  
Width: 14.6" | 37 cm  
Height: 23.6" | 60 cm  
DEPTH: 14.6" | 37 cm

Vol.2  
Width: 27.6" | 70 cm  
Height: 57.1" | 145 cm  
DEPTH: 23.6" | 60 cm  
0.08 + 0.6 m<sup>3</sup> / 55kg

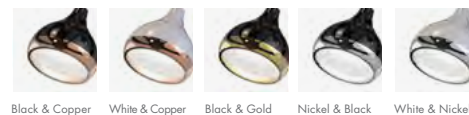
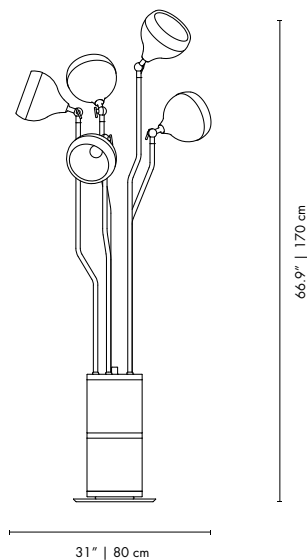

# HERBIE | FLOOR

MATERIALS  
BODY: Brass  
SHADE: Aluminum

WEIGHT  
Approx.: 6.5 kg | 14.3 lbs

BULBS (40W)  
1 x E27 Bulbs (included) (bulbs not included for North America)

DIMENSIONS  
WIDTH: 18.8" | 48 cm  
HEIGHT: 63" | 160 cm  
DEPTH: 9.8" | 25 cm

PACKAGE  
WIDTH: 17.7" | 45 cm  
HEIGHT: 66.9" | 170 cm  
DEPTH: 17.7" | 45 cm  
0.3442 m<sup>3</sup> / 12.7 kg  
(Cardboard Box)

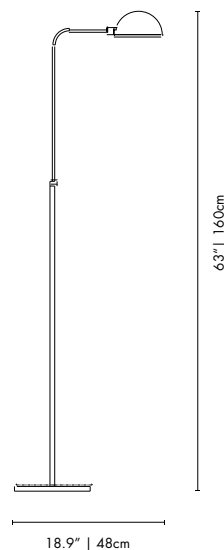

# IKE | FLOOR

**MATERIALS**  
 BODY: Brass  
 SHADE: Brass and Aluminum  
 BASE: Brass and Aluminum

**WEIGHT**  
 Approx.: 12 kg | 26.4 lbs

**BULBS (40W)**  
 3 x G9 Bulbs (included) (bulbs not included for North America)

**DIMENSIONS**  
 HEIGHT: 70.8" | 180cm  
 DIAM.: 15.7" | 40cm

**PACKAGE**  
 (Cardboard Box)  
 Width: 72.8" | 45 cm  
 Height: 76" | 185 cm  
 DEPTH: 72.8" | 45 cm  
 0.3746 m<sup>3</sup> / 21.6 kg

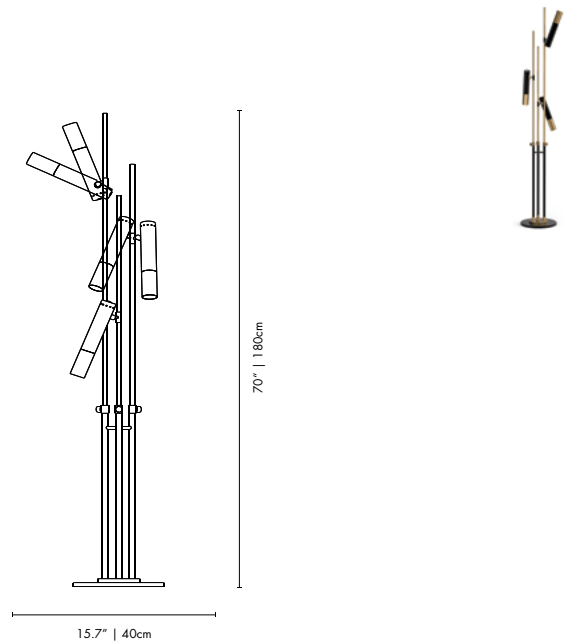

# JACKSON | FLOOR

**MATERIALS**  
 BODY: Brass  
 SHADE: Brass and Aluminum  
 WIRE: Textile

**WEIGHT**  
 Approx.: 12 kg | 26.5 lbs

**BULBS (40W)**  
 3x G9 Bulbs (included) (bulbs not included for North America)

**DIMENSIONS**  
 WIDTH: 31.4" | 80 cm  
 HEIGHT: 70.8" | 180 cm  
 DEPTH: 31.4" | 80 cm

**PACKAGE**  
 (Cardboard Box)  
 PACKAGE  
 WIDTH: 18.1" | 46 cm  
 HEIGHT: 72.8" | 185 cm  
 DEPTH: 18.1" | 46 cm

0.777 m<sup>3</sup> / 19.2 kg

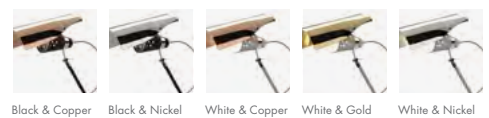
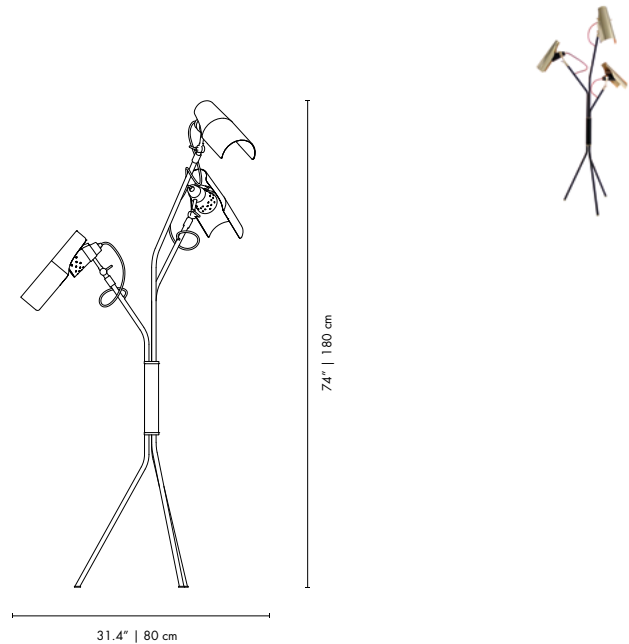

# JANIS | FLOOR

MATERIALS  
BODY: Brass

WEIGHT  
Approx.: 25 kg | 55.1 lbs

BULBS (40W)  
19 x G9 Bulbs (included) (bulbs not included for North America)

DIMENSIONS  
HEIGHT: 66.9" | 170 cm  
DIAM: 16.5" | 42 cm

PACKAGE  
(Cardboard Box)  
HEIGHT: 69.6" | 170 cm  
WIDTH: 20.8" | 53cm  
DEPTH: 20.8" | 53cm  
0.497 m<sup>3</sup> / 42kg

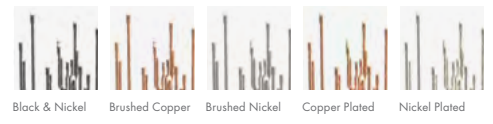
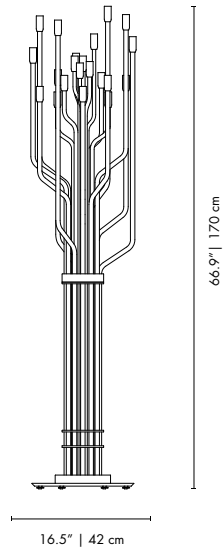

# LEE | FLOOR

MATERIALS  
BODY: Brass  
SHADE: Aluminum  
TOP COVER: Brass

WEIGHT  
Approx.: 10 kg | 22 lbs

BULBS (40W)  
1x E27 Bulb (included) (bulbs not included for North America)

DIMENSIONS  
HEIGHT: 65.4" | 166 cm  
WIDTH: 11.8" | 30 cm  
Depth: 9.8" | 25 cm

PACKAGE  
(Cardboard Box)  
WIDTH: 27.5" | 70 cm  
HEIGHT: 71.5" | 181 cm  
DEPTH: 22.8" | 58cm  
0.7349 m<sup>3</sup>

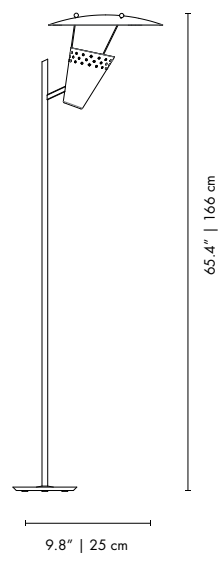

# MATHENY | FLOOR

**MATERIALS**  
 BODY: Brass

**WEIGHT**  
 Approx.: 40 kg | 88 lbs

**BULBS (40W)**  
 9 x E27 Bulb (included) (bulbs not included for North America)

**DIMENSIONS**  
 HEIGHT: 65" | 165 cm  
 DIAM: 13.8" | 35 cm

**PACKAGE**  
 (Cardboard Box)  
 WIDTH: 18.11" | 46cm  
 HEIGHT: 71.5" | 182 cm  
 DEPTH: 18.11 | 46m  
 0.385 m<sup>3</sup> / 45 Kg

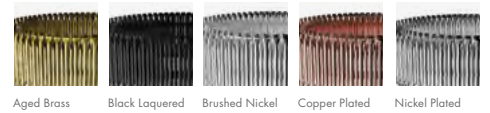
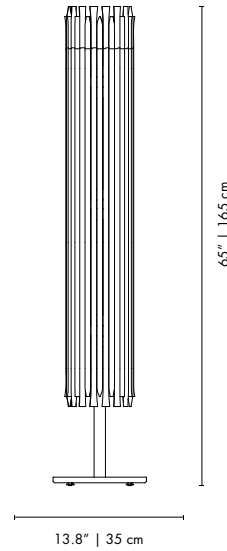

# MILES | FLOOR

**MATERIALS**  
 BODY: Brass  
 SHADE: Aluminum  
 BASE: Marble Portoro (Polished)

**WEIGHT**  
 Approx.: 18.5 kg | 40.8 lbs

**BULBS (40W)**  
 4 x E27 Bulb (included) (bulbs not included for North America)

**DIMENSIONS**  
 HEIGHT: 69.7" | 177 cm  
 DIAM: 25.6" | 65 cm

**PACKAGE**  
 (Cardboard Box)  
 Vol.1  
 WIDTH: 17.7" | 45cm  
 HEIGHT: 70.8" | 180 cm  
 DEPTH: 17.7" | 45m  
 0.294m<sup>3</sup>  
 Vol.2  
 WIDTH: 27.5" | 70cm  
 HEIGHT: 23.6" | 60cm  
 DEPTH: 27.5" | 70m  
 0.364 m<sup>3</sup>  
 37 kg

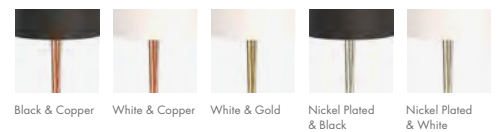
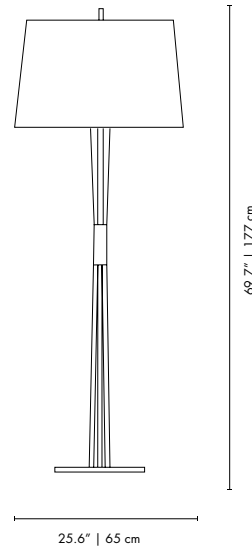

# NEIL | FLOOR

MATERIALS  
 BODY: Brass  
 SHADE: Aluminum  
 WIRE: Textile

WEIGHT  
 Approx.: 20 kg | 44.1 lbs

BULBS (40W)  
 3 x E27 Bulb (included) (bulbs not included for North America)

DIMENSIONS  
 HEIGHT: 69.3" | 176 cm  
 DIAM: 26" | 65 cm

PACKAGE  
 (Cardboard Box)  
 HEIGHT: 72.8" | 185 cm  
 WIDTH: 29.5" | 75cm  
 DEPTH: 29.5" | 75m  
 1.04 m<sup>3</sup> / 37 kg

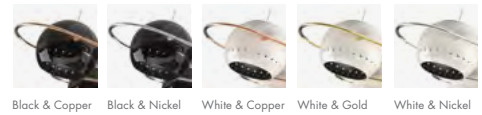
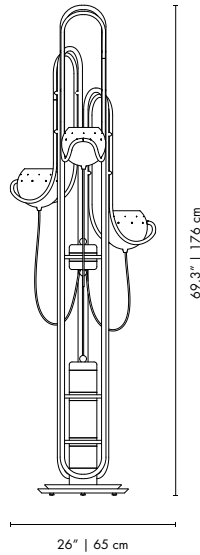

# PASTORIUS | FLOOR

MATERIALS  
 BODY: Brass  
 SHADE: Aluminum and Acrylic

WEIGHT  
 Approx.: 6 kg | 13.2 lbs

BULBS (40W)  
 2 x E27 Bulb (included) (bulbs not included for North America)

DIMENSIONS  
 HEIGHT: 70.1" | 178 cm  
 WIDTH: 24.4" | 62 cm  
 DEPTH: 11.8" | 30 cm

PACKAGE  
 (Cardboard Box)  
 WIDTH: 27.2" | 69cm  
 HEIGHT: 62.20" | 158cm  
 DEPTH: 28.3" | 58cm  
 0,6323 m<sup>3</sup>/15kg

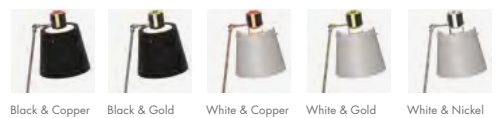
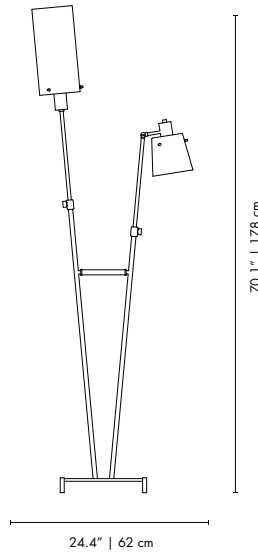

# SCOFIELD | FLOOR

**MATERIALS**  
 BODY: Brass  
 SHADE: Aluminum and Brass  
 Wire: Textile

**WEIGHT**  
 Approx.: 12 kg | 26.5 lbs

**BULBS (40W)**  
 5 x Gu10 Bulbs (included) (bulbs not included for North America)

**DIMENSIONS**  
 HEIGHT: 71.6" | 182 cm  
 DIAM.: 14.1" | 36 cm

**PACKAGE**  
 (Cardboard Box)  
 HEIGHT: 62.20" | 190cm  
 WIDTH: 27.5" | 70cm  
 DEPTH: 23.6" | 60cm  
 0.798 m<sup>3</sup> / 24.4 kg

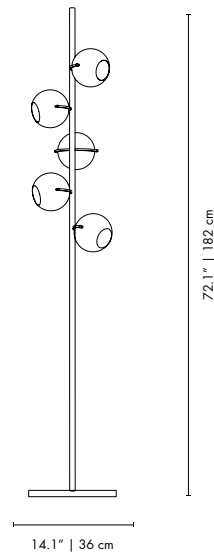

Black & Copper    Black & Gold    Copper & Blue    White & Gold    Nickel & Black

# SIMONE | FLOOR

**MATERIALS**  
 BODY: Brass  
 SHADE: Aluminum  
 Wire: Textile

**WEIGHT**  
 Approx.: 15 kg | 33 lbs

**BULBS (40W)**  
 3 x E27 Bulbs (included) (bulbs not included for North America)

**DIMENSIONS**  
 HEIGHT: 70.9" | 180 cm  
 WIDTH: 51.2" | 130 cm  
 DEPTH: 39.4" | 100 cm

**PACKAGE**  
 (Cardboard Box)  
 WIDTH: 27.5" | 70cm  
 HEIGHT: 80.7" | 205cm  
 DEPTH: 22.8" | 58cm  
 0.8323 m<sup>3</sup> / 30kg

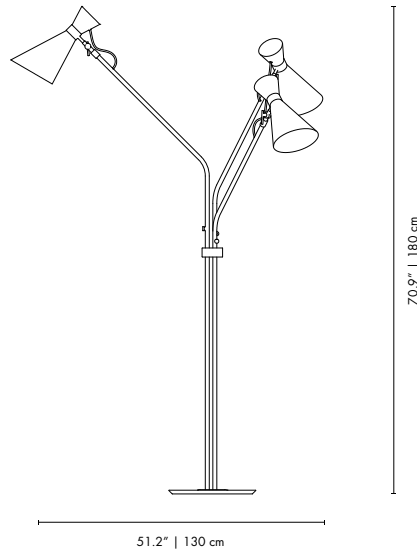

Black & Copper    Blue & Gold    Blue & Nickel    White & Copper    White & Gold



## SINATRA | FLOOR

**MATERIALS**  
 BODY: Brass  
 SHADE: Aluminum  
 COUNTER WEIGHT: Steel

**WEIGHT**  
 Approx.: 12 kg | 26.5 lbs

**BULBS (40W)**  
 3 x E27 Bulbs (included) (bulbs not included for North America)

**DIMENSIONS**  
 HEIGHT: 70.9" | 180 cm  
 WIDTH: 51.2" | 130 cm  
 DEPTH: 39.4" | 100 cm

**PACKAGE**  
 (Cardboard Box)  
 70 x 60 x 165 cm  
 HEIGHT: 64.9" | 165 cm  
 WIDTH: 27.5" | 70 cm  
 DEPTH: 23.6" | 60 cm  
 0.693 m<sup>3</sup> / 24 kg

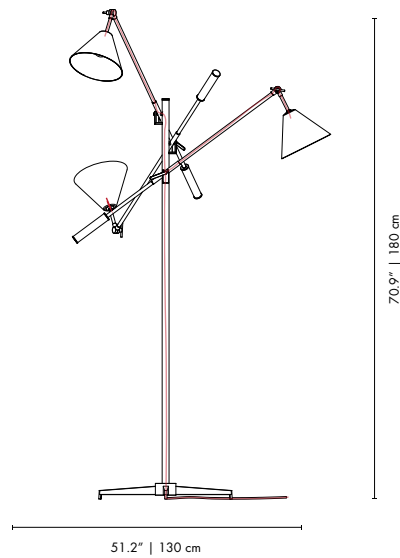

## STANLEY | FLOOR

**MATERIALS**  
 BODY: Brass  
 SHADE: Aluminum  
 COUNTER WEIGHT: Steel

**WEIGHT**  
 Approx.: 13 kg | 28.6 lbs

**BULBS (40W)**  
 3 x E27 Bulbs (included) (bulbs not included for North America)

**DIMENSIONS**  
 HEIGHT: 70.9" | 180 cm  
 WIDTH: 51.2" | 130 cm  
 DEPTH: 39.4" | 100 cm

**PACKAGE**  
 (Cardboard Box)  
 HEIGHT: 64.9" | 165 cm  
 WIDTH: 39.3" | 100 cm  
 DEPTH: 25.5" | 65 cm  
 1.0725 m<sup>3</sup> / 26 kg

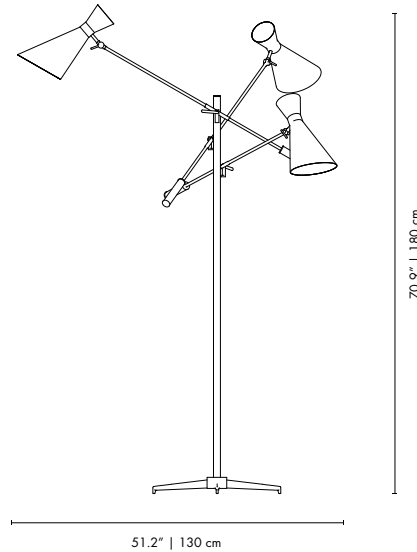

# STARDUST | FLOOR

**MATERIALS**  
 BODY: Brass

**WEIGHT**  
 Approx.: 18 kg | 40 lbs

**BULBS (40W)**  
 7 x E14 Bulbs (included) (bulbs not included for North America)

**DIMENSIONS**  
 HEIGHT: 66.5" | 169 cm  
 DIAM.: 15.7" | 40 cm

**PACKAGE**  
 (Cardboard Box)  
 175 x 70 x 60 cm  
 HEIGHT: 68.9" | 175cm  
 WIDTH: 27.5" | 70cm  
 DEPTH: 23.6" | 60cm  
 0.74m<sup>3</sup> / 33Kg

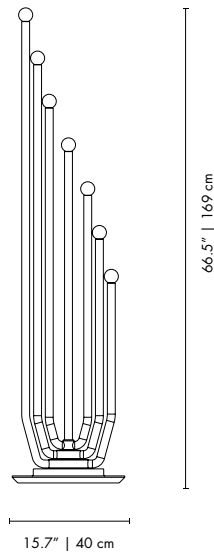

66.5" | 169 cm

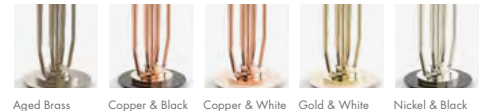

# TORCHIERE | FLOOR

**MATERIALS**  
 BODY: Brass  
 SHADE: Aluminum

**WEIGHT**  
 Approx.: 17 kg | 37 lbs

**BULBS (40W)**  
 3 x E27 Bulbs (included) (bulbs not included for North America)

**DIMENSIONS**  
 HEIGHT: 66.9" | 170 cm  
 DIAM.: 55.1" | 140 cm

**PACKAGE**  
 (Cardboard Box)  
 HEIGHT: 70.8" | 180cm  
 WIDTH: 27.1" | 69cm  
 DEPTH: 22.8" | 58cm  
 0.7203 m<sup>3</sup> | 23 kg

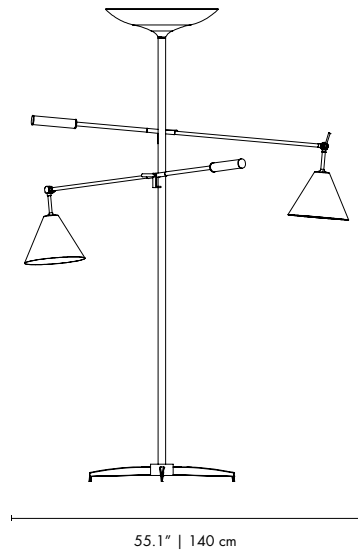

66.9" | 170 cm



# TURNER | FLOOR

**MATERIALS**  
BODY: Brass  
SHADE: Aluminum

**WEIGHT**  
Approx.: 23 kg | 50 lbs

**BULBS (40W)**  
4 x G9 Bulbs (included) (bulbs not included for North America)

**DIMENSIONS**  
HEIGHT: 66.9" | 170 cm  
DIAM.: 19.7" | 50 cm

**PACKAGE**  
(Cardboard Box)  
HEIGHT: 72.8" | 185cm  
WIDTH: 29.5" | 75cm  
DEPTH: 29.5" | 75cm  
1.04 m<sup>3</sup> | 38 kg

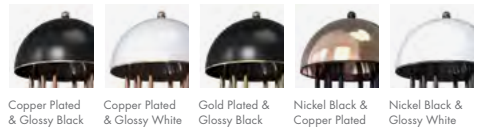
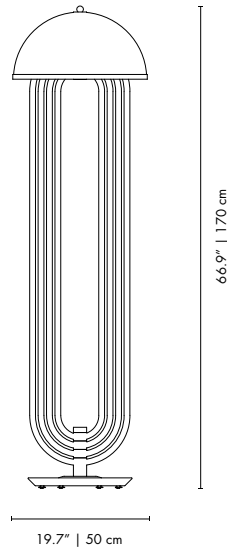



# TABLE LAMPS

# AMY | TABLE

MATERIALS  
BODY: Brass  
SHADE: Aluminum

WEIGHT  
Approx.: 2.5 kg | 5.5 lbs

BULBS (40W)  
2 x E14 (included) (bulbs not included for North America)

DIMENSIONS  
WIDTH: 7.8" | 20 cm  
HEIGHT: 21.6" | 55 cm  
DEPTH: 11.8" | 30 cm

PACKAGE  
(Cardboard Box)  
Height: 22.83" | 58cm  
Width: 14.96" | 38cm  
Depth: 14.96" | 38cm  
0.084 m<sup>3</sup> / 5 kg

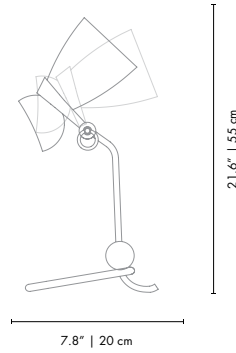

# ATOMIC | TABLE

MATERIALS  
BODY: Brass and Steel  
SHADE: Steel

WEIGHT  
Approx.: 9 kg | 20 lbs

BULBS (40W)  
4 x G9 Bulbs (included) (bulbs not included for North America)

DIMENSIONS  
HEIGHT: 22.2" | 56.5 cm  
Width: 17.5" | 44.5 cm  
DEPTH: 17.5" | 44.5 cm

PACKAGE  
(Cardboard Box)  
Height: 21.65" | 55cm  
Width: 24.41" | 62cm  
Depth: 24.41" | 62cm  
0.211 m<sup>3</sup> / 16kg

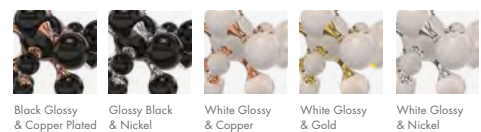
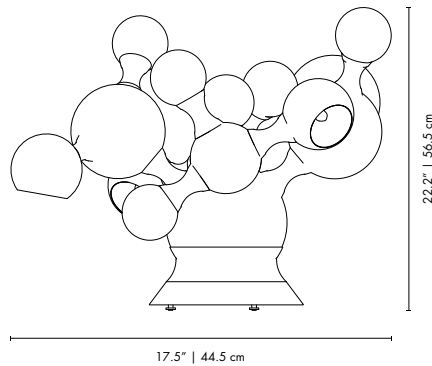

## BARRY | TABLE

**MATERIALS**  
 BODY: Brass  
 SHADE: Aluminium  
 TOP COVER: Aluminum

**WEIGHT**  
 Approx.: 1.5 kg | 3.3 lbs

**BULBS (40W)**  
 1 x E14 Bulb (included) (bulbs not included for North America)

**DIMENSIONS**  
 WIDTH: 12.2" | 31 cm  
 HEIGHT: 12.6" | 32 cm  
 DEPTH: 13.4" | 34 cm

**PACKAGE**  
 (Cardboard Box)  
 Height: 14.96" | 38 cm  
 Width: 14.96" | 38 cm  
 Depth: 13.78" | 35 cm  
 0.05 m<sup>3</sup> / 3,2kg

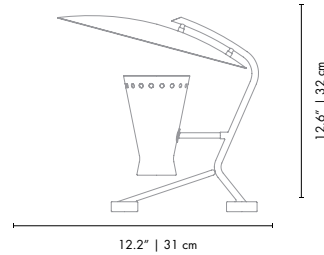

Black Glossy & Copper Plated    Black Glossy & Gold Plated    Black Glossy & Nickel Plated    White/Black Glossy & Copper Plated    White/Black Glossy & Gold Plated

## BASIE | TABLE

**MATERIALS**  
 BODY: Brass  
 SHADE: Aluminium  
 BASE: Marble

**WEIGHT**  
 Approx.: 12 kg | 26.5 lbs

**BULBS (40W)**  
 2 x G9 Bulb (included) (bulbs not included for North America)

**DIMENSIONS**  
 WIDTH: 19.2" | 49 cm  
 HEIGHT: 19.6" | 50 cm  
 DEPTH: 16.1" | 41 cm

**PACKAGE**  
 (Cardboard Box)  
 Height: 22.44" | 57 cm  
 Width: 24.02" | 61 cm  
 Depth: 24.02" | 61 cm  
 0.2120 m<sup>3</sup> / 16kg

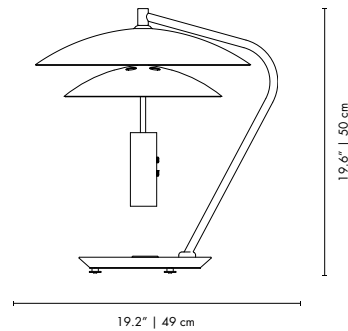

White Matte & Gold Plated

## BILLY | TABLE

**MATERIALS**  
 BODY: Brass  
 SHADE: Aluminum and Brass  
 WIRE: Textile

**WEIGHT**  
 Approx.: 5.7 kg | 12.5 lbs

**BULBS (40W)**  
 2 x G9 Bulb (included) (bulbs not included for North America)

**DIMENSIONS**  
 HEIGHT: Min. 15.8" | 40 cm Max. 23.6" | 60 cm  
 WIDTH: 9.8" | 25 cm  
 DEPTH: 7.9" | 20 cm

**PACKAGE**  
 (Cardboard Box)  
 Height: 25.59" | 65cm  
 Width: 15.75" | 40cm  
 Depth: 15.75" | 40cm  
 0.104 m<sup>3</sup>/9.2 Kg

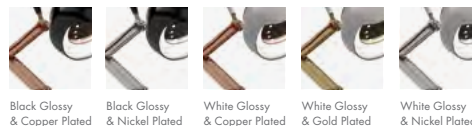
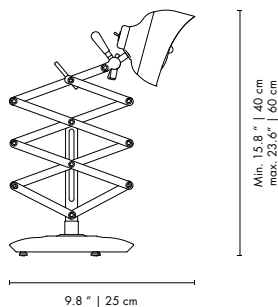

## BOTTI | TABLE

**MATERIALS**  
 BODY: Nero Marquina and Brass  
 SHADE: Brass

**WEIGHT**  
 Approx.: 25 kg | 55 lbs

**BULBS (40W)**  
 11 x E14 Silver Crown Bulbs (included) (bulbs not included for North America)

**DIMENSIONS**  
 HEIGHT: 27.6" | 67.5 cm  
 DIAMETER: 16.5" | 42 cm

**PACKAGE**  
 (Plywood Box)  
 Height: 35.43" | 90cm  
 Width: 21.65" | 55cm  
 Depth: 21.65" | 55cm  
 0.272 m<sup>3</sup> / 30 kg

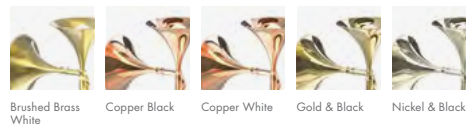
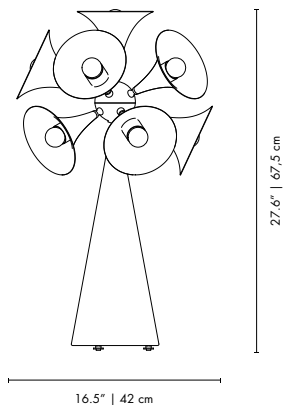

## COLTRANE | TABLE

MATERIALS  
 BODY: Steel  
 SHADE: Brass

WEIGHT  
 Approx.: 5 kg | 6.6 lbs

BULBS (40W)  
 3 x E14 Silver Crown Bulbs (included) (bulbs not included for North America)

DIMENSIONS  
 HEIGHT: 24.4" | 62 cm  
 DIAMETER: 7.5" | 19 cm

PACKAGE  
 (Cardboard Box)  
 Height: 27.56" | 70cm  
 Width: 15.75" | 40cm  
 Depth: 15.75" | 40cm  
 0.112 m<sup>3</sup> / 13 kg

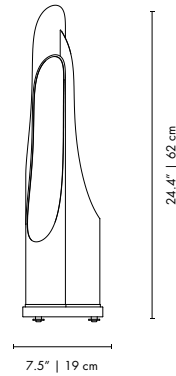

## DIANA | TABLE

MATERIALS  
 BODY: Brass  
 SHADE: Aluminum

WEIGHT  
 Approx.: 1.5 kg | 3.3 lbs

BULBS (40W)  
 1 x E27 Bulb (included) (bulbs not included for North America)

DIMENSIONS  
 WIDTH: 13.4" | 34 cm  
 HEIGHT: 16.9" | 43 cm  
 LENGTH: 11" | 28 cm

PACKAGE  
 (Cardboard Box)  
 Height: 22.83" | 58cm  
 Width: 14.96" | 38cm  
 Depth: 14.96" | 38cm  
 0.084 m<sup>3</sup> / 4.2 kg

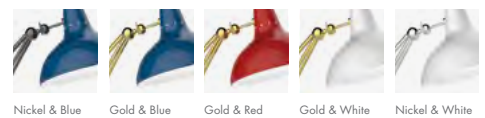
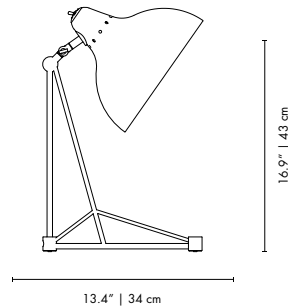



## DONNA | TABLE

### MATERIALS

BODY: Brass and Estremoz Marble  
SHADE: Brass

### WEIGHT

Approx.: 20 kg | 44 lbs

### BULBS (40W)

6 x G9 Bulbs (included) (bulbs not included for North America)

### DIMENSIONS

HEIGHT: 27.6" | 70 cm  
DIAM.: 9.8" | 25 cm

### PACKAGE

(Cardboard Box)  
Height: 31.5" | 80cm  
Width: 15.75" | 40cm  
Depth: 15.75" | 40cm  
0.128 m<sup>3</sup> / 24 Kg

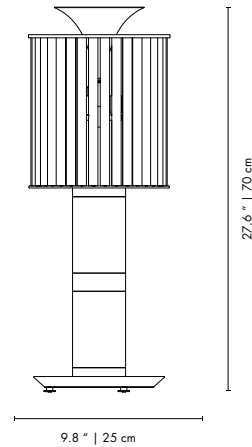

Estremoz Marble & Copper

Portoro Marble & Copper

Portoro Marble & Gold

Estremoz Marble & Nickel

Portoro Marble & Nickel

## JANIS | TABLE

### MATERIALS

BODY: Brass

### WEIGHT

Approx.: 11 kg | 24.3 lbs

### STANDARD FINISHES

BODY: Gold Plated

### BULBS (40W)

12 x G9 Bulbs (included) (bulbs not included for North America)

### DIMENSIONS

WIDTH: 9" | 23 cm  
HEIGHT: 27.5" | 70 cm  
DEPTH: 9" | 23 cm

### PACKAGE

(Cardboard Box)  
Height: 32.68" | 83cm  
Width: 14.96" | 38cm  
Depth: 14.96" | 38cm  
0.1198 m<sup>3</sup> / 14 Kg

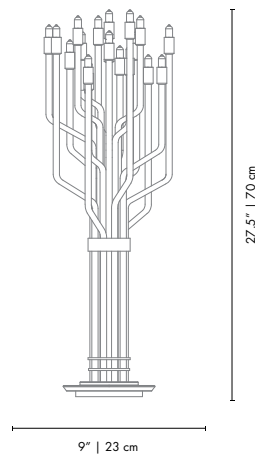

Black & Nickel

Brushed Copper

Brushed Nickel

Copper Plated

Nickel Plated

## KENNY | TABLE

MATERIALS  
 BASE: Marble  
 SHADE: Brass

DIMENSIONS  
 WIDTH: 11.42" | 29 cm  
 HEIGHT: 22.05" | 56 cm

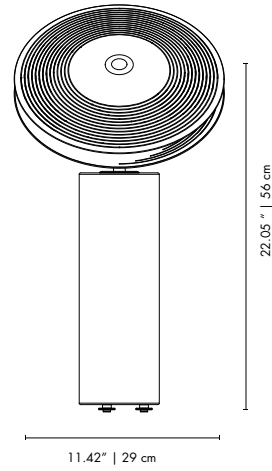

## MARCUS | TABLE

MATERIALS  
 BODY: Brass  
 SHADE: Aluminum and Steel

WEIGHT  
 Approx.: 3.5 kg | 7.7 lbs

BULBS (40W)  
 1x E27 Bulb (included) (bulbs not included for North America)

DIMENSIONS  
 WIDTH: 11.8" | 30 cm  
 HEIGHT: 13.8" | 35 cm  
 DEPTH: 7.5" | 19 cm

PACKAGE  
 (Cardboard Box)  
 Height: 17.72" | 45cm  
 Width: 15.75" | 40cm  
 Depth: 15.75" | 40cm  
 0.072 m³/ 6.5 kg

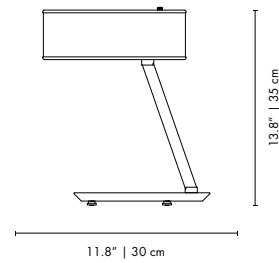

Black & Copper    Black & Gold    White Matte & Copper    White Matte & Gold    White Matte & Nickel

## MATHENY | TABLE

MATERIALS  
BODY: Brass  
BASE: Marble

WEIGHT  
Approx.: 11 kg | 24.3 lbs

BULBS (40W)  
3 x G9 Bulbs (included) (bulbs not included for North America)

DIMENSIONS  
WIDTH: 7.4" | 19 cm  
HEIGHT: 22.8" | 58 cm  
DEPTH: 7.4" | 19 cm

PACKAGE  
(Cardboard Box)  
Height: 25.2" | 64cm  
Width: 14.57" | 37cm  
Depth: 14.57" | 37cm  
0.0876 m<sup>3</sup> / 14 Kg

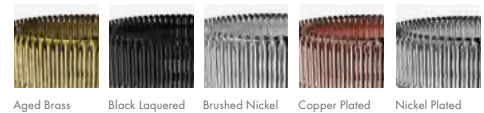
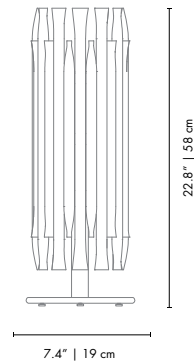

## MEOLA | TABLE

MATERIALS  
BODY: Brass  
SHADE: Aluminum

WEIGHT  
Approx.: 3 kg | 6.6 lbs

BULBS (40W)  
1 x E14 Bulb (included) (bulbs not included for North America)

DIMENSIONS  
HEIGHT: 11" | 28 cm  
DIAM.: 9.8" | 25 cm

PACKAGE  
(Cardboard Box)  
Height: 15.75" | 40cm  
Width: 15.75" | 30cm  
Depth: 15.75" | 30cm  
0.64 m<sup>3</sup> / 4 kg

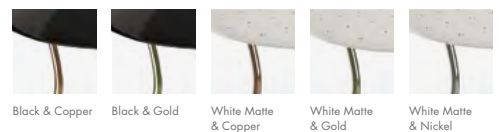
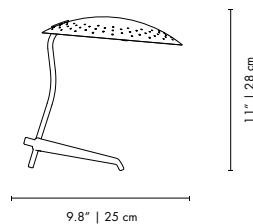

## MILES | TABLE

**MATERIALS**  
 BODY: Brass  
 SHADE: Aluminum

**WEIGHT**  
 Approx.: 4 kg | 8.8 lbs

**BULBS (40W)**  
 3 x E27 Bulbs (included) (bulbs not included for North America)

**DIMENSIONS**  
 HEIGHT: 18.1" | 46 cm  
 DIAM.: 13.4" | 34 cm

**PACKAGE**  
 (Cardboard Box)  
 Height: 29.53" | 75cm  
 Width: 15.75" | 40cm  
 Depth: 15.75" | 40cm  
 0.225 m<sup>3</sup> / 10.5 kg

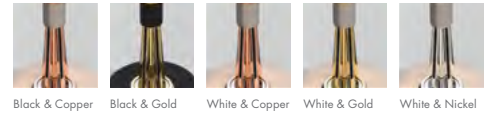
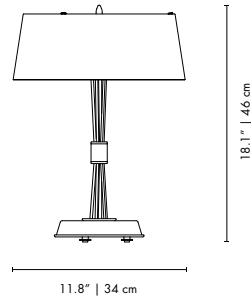

## TURNER | TABLE

**MATERIALS**  
 BODY: Brass  
 SHADE: Aluminum

**WEIGHT**  
 Approx.: 7.5 kg | 16.5 lbs

**BULBS (40W)**  
 3 x G9 Bulbs (included) (bulbs not included for North America)

**DIMENSIONS**  
 HEIGHT: 23.6" | 60 cm  
 DIAM.: 11.8" | 34 cm

**PACKAGE**  
 (Cardboard Box)  
 Height: 28.35" | 72cm  
 Width: 17.72" | 45cm  
 Depth: 17.72" | 45cm  
 0.146 m<sup>3</sup> / 12.8 kg

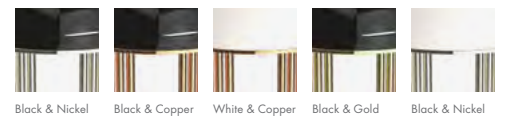
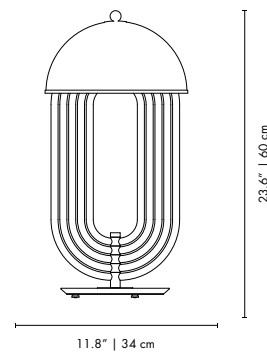



# WALL LAMPS



# ATOMIC | WALL

**MATERIALS**

BODY: Brass and Steel  
SHADE: Steel

**WEIGHT**

Approx.: 4.3 kg | 9.5 lbs

**BULBS (40W)**

7 x G9 Bulbs (included) (bulbs not included for North America)

**DIMENSIONS**

HEIGHT: 20" | 51 cm  
WIDTH: 18.7" | 47.5 cm  
DEPTH: 12.6" | 32 cm

**PACKAGE**

(Cardboard Box)  
HEIGHT: 24.4" | 62 cm  
WIDTH: 24.4" | 62 cm  
DEPTH: 17.7" | 45 cm  
0.173 m<sup>3</sup> / 12 kg

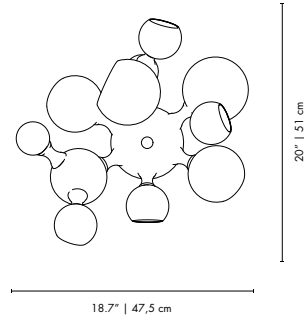

Black Glossy & Copper Plated    Glossy Black & Nickel    White Glossy & Copper    White Glossy & Gold    White Glossy & Nickel

# BASIE | WALL

**MATERIALS**

BODY: Brass  
SHADE: Aluminum

**WEIGHT**

Approx.: 8 kg | 17.6 lbs

**BULBS (40W)**

3 x G9 Bulbs (included) (bulbs not included for North America)

**DIMENSIONS**

HEIGHT: 18.1" | 46 cm  
WIDTH: 12.2" | 31 cm  
DEPTH: 16.1" | 41 cm

**PACKAGE**

(Cardboard Box)  
HEIGHT: 24" | 61 cm  
WIDTH: 16.5" | 42 cm  
DEPTH: 24" | 61 cm  
0.15 m<sup>3</sup> / 12 kg

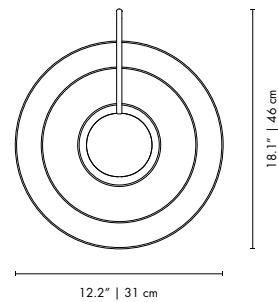

White Matte & Gold Plated

## BRUBECK | WALL

MATERIALS  
BODY: Brass

WEIGHT  
Approx.: 3 kg | 13.2 lbs

BULBS (40W)  
4 x G9 Bulbs (included) (bulbs not included for North America)

DIMENSIONS  
HEIGHT: 5.9" | 15 cm  
WIDTH: 19.7" | 50 cm  
DEPTH: 4.3" | 11 cm

PACKAGE  
HEIGHT: 11" | 28 cm  
WIDTH: 22.8" | 58 cm  
DEPTH: 8.7" | 22 cm  
0.0357 m<sup>3</sup> / 5.5 kg

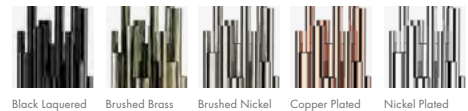

## CHARLES | WALL

MATERIALS  
BODY: Brass  
SHADE: Brass

WEIGHT  
Approx.: 1 kg | 2.2 lbs

BULBS (40W)  
1 x E27 Bulb (included) (bulbs not included for North America)

DIMENSIONS  
HEIGHT: 10.2" | 26 cm  
WIDTH: 5.9" | 15 cm  
DEPTH: 6.3" | 16 cm

PACKAGE  
(Cardboard Box)  
HEIGHT: 15.8" | 40 cm  
WIDTH: 8.7" | 22 cm  
DEPTH: 9.5" | 24 cm  
0.021 m<sup>3</sup> / 1.5 kg

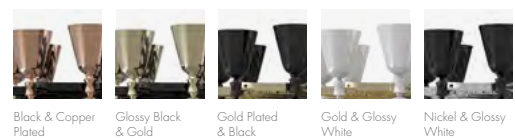
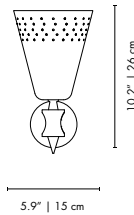

# CHUCK 3 | WALL

**MATERIALS**

BODY: Brass  
 SHADE: Steel and Brass

**WEIGHT**

Approx.: 3 kg | 6.6 lbs

**BULBS (40W)**

3 x E14 Reflector light Bulbs (included) (bulbs not included for North America)

**DIMENSIONS**

HEIGHT: 17.3" | 44 cm  
 WIDTH: 3.9" | 10 cm  
 DEPTH: 6.7" | 17 cm

**PACKAGE**

(Cardboard Box)  
 HEIGHT: 17.3" | 44 cm  
 WIDTH: 3.9" | 10 cm  
 DEPTH: 6.3" | 16 cm  
 0.01 m<sup>3</sup> / 4 kg

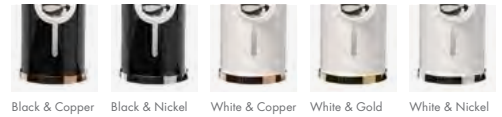
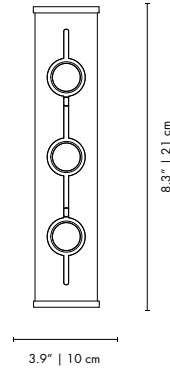

# COLTRANE | WALL

**MATERIALS**

BODY: Aluminum

**WEIGHT**

Approx.: 2 kg | 4.4 lbs

**BULBS (40W)**

2 x G410 Bulbs (included) (bulbs not included for North America)

**DIMENSIONS**

HEIGHT: 39.4" | 100 cm  
 WIDTH: 3.1" | 8 cm  
 DEPTH: 3.9" | 10 cm

**PACKAGE**

(Cardboard Box)  
 Height: 46.4" | 118 cm  
 Width: 10.7" | 27cm  
 Depth: 10.7" | 27cm  
 0.086 m<sup>3</sup> / 4.7 kg

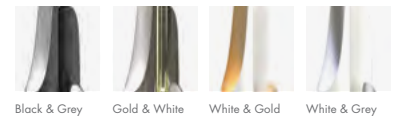
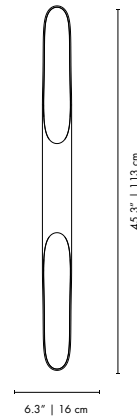



# DIANA | WALL

MATERIALS  
BODY: Brass  
SHADE: Aluminum  
COUNTERWEIGHT: Steel

WEIGHT  
Approx.: 7 kg | 22 lbs

BULBS (40W)  
1 x E27 Bulb (bulbs not included for North America)

DIMENSIONS  
HEIGHT: 19.7" | 50 cm  
DEPTH: 59.1" | 150 cm  
WIDTH: 11.8" | 30 cm

PACKAGE  
(Cardboard Box)  
HEIGHT: 18.1" | 46 cm  
DEPTH: 39.4" | 100 cm  
WIDTH: 18.1" | 46 cm  
0.2116 m<sup>3</sup> / 10 kg

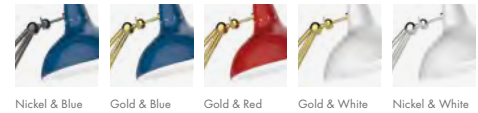
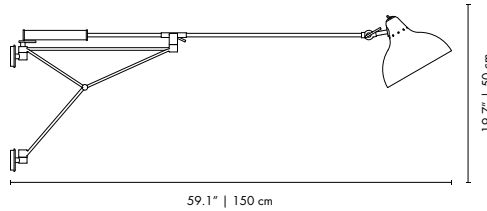

# DIZZY | WALL

MATERIALS  
BODY: Brass  
SHADE: Brass

WEIGHT  
Approx.: 1 kg | 2.2 lbs

BULBS (40W)  
1 x E27 Bulb (bulbs not included for North America)

DIMENSIONS  
HEIGHT: 16.1" | 41 cm  
WIDTH: 7.5" | 19 cm  
DEPTH: 8.7" | 22 cm

PACKAGE  
(Cardboard Box)  
HEIGHT: 18.5" | 47 cm  
WIDTH: 8.3" | 21 cm  
DEPTH: 10.6" | 27 cm  
0.0267 m<sup>3</sup> / 2 kg

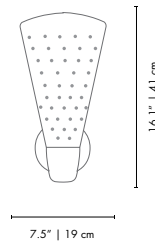

## ELLA | WALL

**MATERIALS**  
 BODY: Brass  
 SHADE: Aluminum

**WEIGHT**  
 Approx.: 1.5 kg | 3.3 lbs

**BULBS (40W)**  
 2 x G9 Bulbs (included) (bulbs not included for North America)

**DIMENSIONS**  
 HEIGHT: 9.5" | 24 cm  
 WIDTH: 13" | 33 cm  
 DEPTH: 7.1" | 18 cm

**PACKAGE**  
 (Cardboard Box)  
 HEIGHT: 19.7" | 50 cm  
 WIDTH: 19.7" | 50 cm  
 DEPTH: 13.8" | 35 cm  
 0.088 m<sup>3</sup> / 3.5 kg

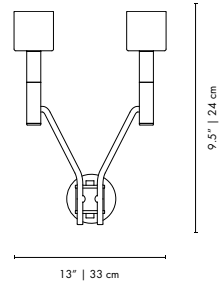

## ETTA | WALL

**MATERIALS**  
 BODY: Brass

**WEIGHT**  
 Approx.: 6 kg | 13.2 lbs

**BULBS (40W)**  
 4 x G9 Bulbs (included) (bulbs not included for North America)

**DIMENSIONS**  
 HEIGHT: 20" | 50 cm  
 WIDTH: 7.1" | 18 cm  
 DEPTH: 7.1" | 18 cm

**PACKAGE**  
 (Cardboard Box)  
 HEIGHT: 23.6" | 60 cm  
 WIDTH: 7.8" | 20 cm  
 DEPTH: 11.8" | 30 cm  
 0.036 m<sup>3</sup> / 4.8 kg

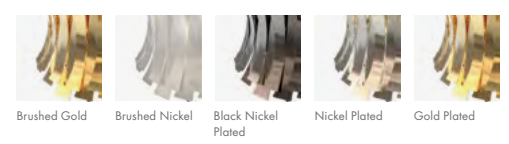
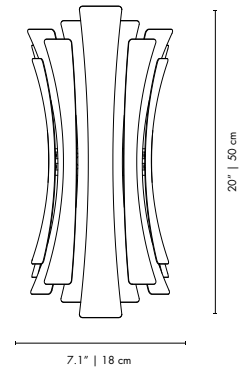

## EVANS | WALL

MATERIALS  
 BODY: Brass  
 SHADE: Aluminum  
 WIRE: Textile

WEIGHT  
 Approx.: 5 kg | 11 lbs

BULBS (40W)  
 2 x E27 Bulbs (included) (bulbs not included for North America)

DIMENSIONS  
 HEIGHT: 25.5" | 65 cm  
 WIDTH: 13.7" | 35 cm  
 DEPTH: 11.8" | 30 cm

PACKAGE  
 (Cardboard Box)  
 HEIGHT: 33.1" | 84 cm  
 WIDTH: 13" | 33 cm  
 DEPTH: 13" | 33 cm  
 0.091 m<sup>3</sup> / 7kg

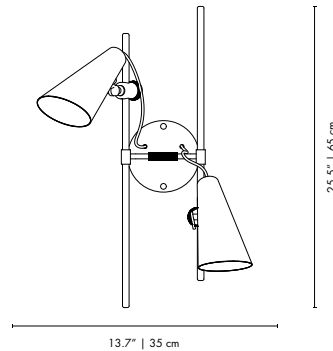

Gold Plated

## GALLIANO | WALL

MATERIALS  
 BODY: Steel

WEIGHT  
 Approx.: 1 kg | 2.2 lbs (per tube)

BULBS (40W)  
 2 x E27 Bulbs (included) (bulbs not included for North America)

DIMENSIONS  
 HEIGHT: 15.6" | 39.5 cm  
 WIDTH: 2.6" | 6.5 cm  
 DEPTH: 3.4" | 8.5 cm

PACKAGE  
 (Cardboard Box)  
 HEIGHT: 21.7" | 55 cm  
 WIDTH: 7.1" | 18 cm  
 DEPTH: 4.7" | 12 cm  
 0.012 m<sup>3</sup> / 2 Kg

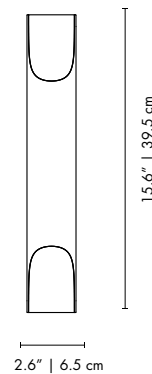

Black & Grey

Gold & White

White & Gold

White & Grey

# HANNA | WALL

**MATERIALS**  
 BODY: Brass  
 SHADE: Brass and Aluminum

**WEIGHT**  
 Approx.: 2 kg | 4.4 lbs

**BULBS (40W)**  
 1 x E27 Bulbs (included) (bulbs not included for North America)

**DIMENSIONS**  
 HEIGHT: 9.4" | 24 cm  
 WIDTH: 7.1" | 18 cm  
 DEPTH: 9.8" | 25 cm

**PACKAGE**  
 (Cardboard Box)  
 HEIGHT: 12.6" | 32 cm  
 WIDTH: 11.8" | 30 cm  
 DEPTH: 12.6" | 32 cm  
 0.031m<sup>3</sup> / 2 kg

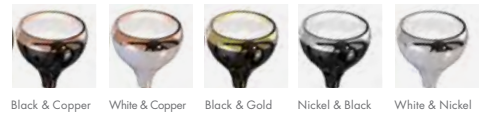
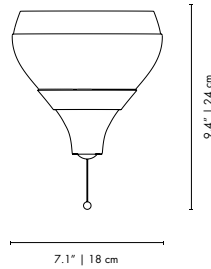

# HENDRIX | WALL

**MATERIALS**  
 BODY: Brass

**WEIGHT**  
 Approx.: 2 kg | 4 lbs

**BULBS (40W)**  
 3x G9 Bulbs (included) (bulbs not included for North America)

**DIMENSIONS**  
 Diam.: 11.8" | 30 cm  
 Depth: 3.5" | 9 cm

**PACKAGE**  
 (Cardboard Box)  
 HEIGHT: 15.8" | 40 cm  
 WIDTH: 15.8" | 40 cm  
 DEPTH: 5.9" | 15 cm  
 0.024 m<sup>3</sup> / 3.2 kg

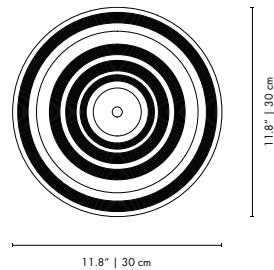

# MATHENY | WALL

MATERIALS  
BODY: Brass

WEIGHT  
Approx.: 2 kg | 4.4 lbs

BULBS (40W)  
4 x G9 Bulbs (included) (bulbs not included for North America)

DIMENSIONS  
HEIGHT: 12.2" | 31 cm  
WIDTH: 7.1" | 18 cm  
DEPTH: 4.7" | 12 cm

PACKAGE  
(Cardboard Box)  
HEIGHT: 19.7" | 50 cm  
WIDTH: 11.8" | 30 cm  
DEPTH: 8.7" | 22 cm  
0.033m<sup>3</sup>/ 4.1 kg

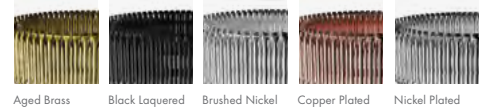
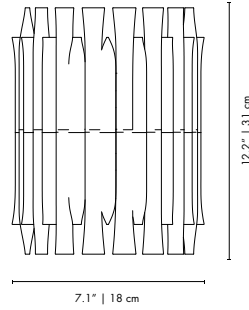

# MILES | WALL

MATERIALS  
BODY: Brass  
SHADE: Aluminum

WEIGHT  
Approx.: 6 kg | 13.2 lbs

BULBS (40W)  
3 x E14 Bulbs (included) (bulbs not included for North America)

DIMENSIONS  
HEIGHT: 13.8" | 35 cm  
WIDTH: 13" | 33 cm  
DEPTH: 16.5" | 42 cm

PACKAGE  
(Cardboard Box)  
HEIGHT: 18.1" | 46 cm  
WIDTH: 15.6" | 40 cm  
DEPTH: 18.1" | 46 cm  
0.0846 m<sup>3</sup> / 7.5 kg

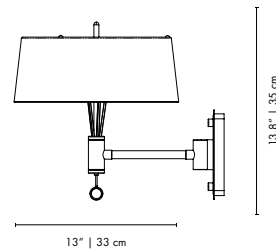

# NORAH | WALL

**MATERIALS**  
 BODY: Brass  
 BULB HOLDER: Aluminum

**WEIGHT**  
 Approx.: 1 kg | 2.2 lbs

**BULBS (40W)**  
 5 x E14 Bulbs (included) (bulbs not included for North America)

**DIMENSIONS**  
 HEIGHT: 15.7" | 40 cm  
 WIDTH: 13.8" | 35 cm  
 DEPTH: 12.2" | 31 cm

**PACKAGE**  
 (Cardboard Box)  
 HEIGHT: 19.7" | 50 cm  
 WIDTH: 19.7" | 50 cm  
 DEPTH: 5.9" | 15 cm  
 0,038 m³ / 2.5kg

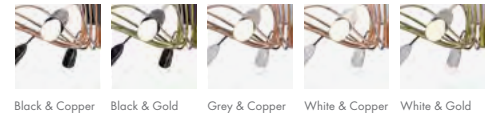
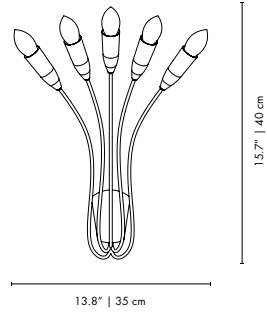

# PARKER | WALL

**MATERIALS**  
 BODY: Brass

**WEIGHT**  
 Approx.: 12 kg | 26.5 lbs

**BULBS (40W)**  
 4 x G9 Bulbs (included) (bulbs not included for North America)

**DIMENSIONS**  
 HEIGHT: 23.6" | 60 cm  
 WIDTH: 7.1" | 18 cm  
 DEPTH: 4.7" | 12 cm

**PACKAGE**  
 (Cardboard Box)  
 HEIGHT: 33.5" | 85 cm  
 WIDTH: 13.8" | 35 cm  
 DEPTH: 13.8" | 35 cm  
 0.104 m³ / 15kg

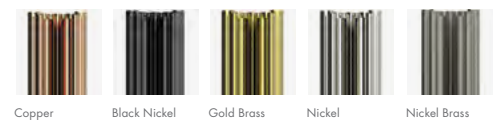
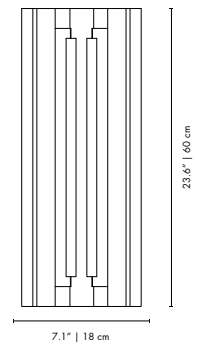

# PASTORIUS | WALL

**MATERIALS**  
 BODY: Brass  
 SHADE: Aluminum  
 HANDLE: Steel  
 WIRE: Textile

**WEIGHT**  
 Approx.: 3 kg | 8.8 lbs

**BULBS (40W)**  
 1 x E27 Bulb (included) (bulbs not included for North America)

**DIMENSIONS**  
 HEIGHT: 10" | 25 cm  
 DEPTH: Min. 12" | 30 cm - Max. 25.6" | 65 cm  
 WIDTH: 5.9" | 15 cm

**PACKAGE**  
 (Cardboard Box)  
 HEIGHT: 22.8" | 58 cm  
 DEPTH: 22.8" | 58 cm  
 WIDTH: 7.9" | 20 cm  
 0.067 m<sup>3</sup> / 4 kg

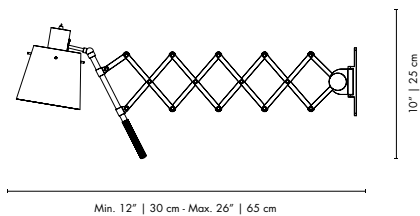

# PIAZZOLLA | WALL

**MATERIALS**  
 BODY: Brass  
 SHADE: Brass and Aluminum

**WEIGHT**  
 Approx.: 1.2 kg | 2.6 lbs

**BULBS (40W)**  
 2x E27 Bulb (included) (bulbs not included for North America)

**DIMENSIONS**  
 HEIGHT: 11.2" | 28.5 cm  
 WIDTH: 5.7" | 14.5 cm  
 DEPTH: 7.5" | 19 cm

**PACKAGE**  
 (Cardboard Box)  
 HEIGHT: 15.8" | 40 cm  
 WIDTH: 8.7" | 22 cm  
 DEPTH: 9.8" | 25 cm  
 0.022 m<sup>3</sup> / 1.8 kg

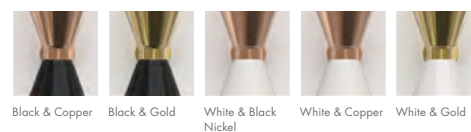
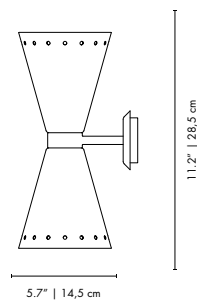

## SIMONE | WALL

MATERIALS  
 BODY: Brass  
 SHADE: Aluminum  
 WIRE: Textile

WEIGHT  
 Approx.: 9 kg | 19.8 lbs

BULBS (40W)  
 3 x E27 Bulb (included) (bulbs not included for North America)

DIMENSIONS  
 HEIGHT: 45.7" | 116 cm  
 WIDTH: 17.7" | 45.5 cm  
 DEPTH: 17.7" | 45.5 cm

PACKAGE  
 (Cardboard Box)  
 HEIGHT: 53.5" | 136 cm  
 WIDTH: 23.6" | 60 cm  
 DEPTH: 27.6" | 70 cm  
 0.5712 m<sup>3</sup> / 16.5 kg

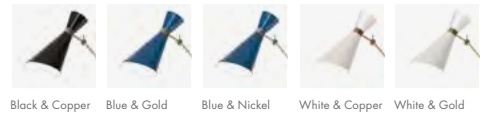
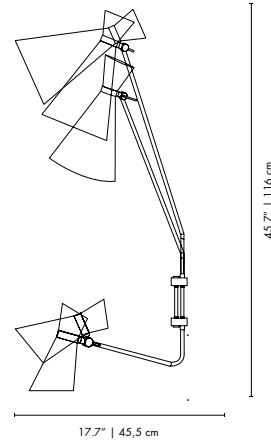

## TURNER | WALL

MATERIALS  
 BODY: Brass  
 SHADE: Aluminum

WEIGHT  
 Approx.: 5.7 kg | 12.6 lbs

BULBS (40W)  
 1 x E27 Bulb (included) (bulbs not included for North America)

DIMENSIONS  
 HEIGHT: 11.8" | 30 cm  
 WIDTH: 37.4" | 95 cm  
 DEPTH: 12.6" | 32 cm

PACKAGE  
 (Cardboard Box)  
 HEIGHT: 17.7" | 45 cm  
 WIDTH: 40.6" | 103 cm  
 DEPTH: 17.7" | 45 cm  
 0.209 m<sup>3</sup> / 5.6Kg

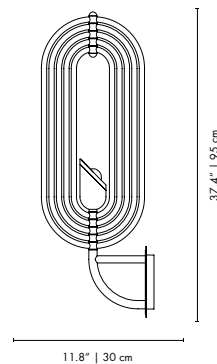





"Delightfull's Soul and Jazz inspired light fixtures are a spirited celebration of mid-century modern style"

LONNY MAGAZINE | USA

"Cool Retro Design, quality materials and funny lights that are named after famous musicians make up the charm of this light objects of Delightfull"

LIGHT + WOHNEN | GERMANY

"If you haven't heard of Delightfull Lamps yet, it's time to crawl out from under the rock"

DESIGN-MILK.COM

DelightFULL®  
Unique Lamps

INFO@DELIGHTFULL.EU | WWW.DELIGHTFULL.EU