

EMPORIUM



CATALOGO N° 00

Sfoggia il futuro...

DESIGNERS



WALTER SBICCA



ROMEO GUARICCI



MAMMINI CANDIDO



ROBERTO GIACOMUCCI



MELISSA GIACCHI



BRIAN RASMUSSEN



ALBERTO VALLESI



UTE



ABOUT US

LO STRAORDINARIO QUOTIDIANO

Dal 1997 **Emporium** coniuga idee, materiali e stile per creare oggetti destinati alla vita di tutti i giorni. Con **Emporium** il design diventa pratico ed accessibile, il quotidiano si trasforma in una esperienza straordinaria, reinterpretando il concetto di luce e di spazio.

Nelle due collezioni "**The Special Light**" e "**Living Book**" il metacrilato, il policarbonato, il legno e le materie plastiche termofuse e riciclate prendono forma grazie a un mix di creatività ed esperienza. Illuminazione e complementi d'arredo vengono pensati per generare emozioni e suscitare un'inequivocabile sensazione di benessere.

POSITIVE DESIGN è il linguaggio di Emporium: una filosofia, un pensiero, uno stile di vita diverso e un modo nuovo di vivere il proprio ambiente. Nascono così creazioni in perfetto stile **Emporium** dal design leggero, essenziale ed ecosostenibile, per entrare nelle case di tutto il mondo.

Tutti i prodotti sono **MADE IN ITALY**.



ABOUT US

THE EXTRAORDINARY EVERYDAY

Emporium is a very fresh brand established in 1997 to promote a new culture of the extraordinary beautiful everyday through objects for lighting and living solutions all 100% designed and made in Italy. Since the early years **Emporium** has been combining ideas, materials and Italian style to create elegant suggestions to surround us day in, day out.

POSITIVE DESIGN is the language of Emporium: a philosophy, a thought, a different lifestyle. Design with Emporium becomes practical and accessible; the everyday becomes an extraordinary experience, reinterpreting the concept of light and space. In the two collections "**The Special Light**" and "**Living Book**" methacrylate, polycarbonate, wood and recycled plastics take shape thanks to a mix of creativity and experience.

Lighting and complementary furnishings are conceived to evoke emotions and offer up an unequivocal feeling of well-being.

This is how products are created in the perfect **Emporium** style, giving them a very light, essential and sustainable design for our worldwide clientele.

All products are **MADE IN ITALY**.



INDICE / INDEX

<i>Lampade da tavolo</i> <i>Table lamps</i>	<i>pag. 8 - 59</i>
<i>Lampade da terra</i> <i>Floor lamps</i>	<i>pag. 60 - 85</i>
<i>Applique</i> <i>Wall lamps</i>	<i>pag. 86 - 103</i>
<i>Plafoniere</i> <i>Ceiling lamps</i>	<i>pag. 104 - 127</i>
<i>Dama collection</i> <i>Plafoniere - Sospensioni</i> <i>Ceiling lamps - Suspension lamps</i>	<i>pag. 128 - 143</i>
<i>Domino collection</i> <i>Plafoniere - Sospensioni</i> <i>Ceiling lamps - Suspension lamps</i>	<i>pag. 144 - 153</i>
<i>Sospensioni</i> <i>Suspension lamps</i>	<i>pag. 154 - 253</i>
<i>Lampade da terra per esterno</i> <i>Outdoor floor lamps</i>	<i>pag. 254 - 257</i>

LAMPADA DELL'AVVOCATO



LAMPADA DELL'AVVOCATO

design by **Walter Sbicca**

CL 1478

Lampada da tavolo: struttura in MDF laccato nero, paralume Sandylex con stampa.

Table lamp. MDF structure coated black. Lampshade in printed Sandylex

Ø 35 cm



H 40 cm

15



CL 1479

Lampada da tavolo: struttura in MDF laccato nero paralume in Sandylex, rivestimento in tessuto con cerniera lampo, disponibile nei decori: feltro grigio, tessuto intrecciato e pizzo nero.

Table lamp. MDF structure coated black. Lampshade in braided Sandylex. Texture coating with zip available in grey felt material, braided net or black lace.

L 35 cm



H 40 cm

91

67

05



ALLEGRETTA

design by **Romeo Guaricci**

CL 1408

Lampada da tavolo in metacrilato disponibile nei colori:
satinato, spectrall e fumé.

Methacrylate table lamp available in:
opaline white, spectrall and smoked grey.

12 88 98

Ø 22 cm Attacco E14.
Lampadine: 1 x 15 W max - E14 FBT



E14 screw.
Bulbs: 1 x 15 W max - E14 FBT



CL 1409

Lampada da tavolo in metacrilato disponibile nel colore: TexturGold

Methacrylate table lamp available in: TexturGold.

58

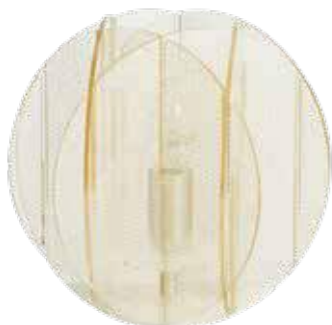

ALLEGRETTA

design by Romeo Guaricci



AMARILLI

design by **Roberto Giacomucci**

CL 485

Lampada da tavolo in metacrilato disponibile nei colori:
trasparente, satinato, rosso, cromolite, spectrall, fumé e texturgold.

Methacrylate table lamp available in: transparent, opaline white, red,
cromolite, spectrall, smoked grey and texture gold.

11 12 51 88 98

L 22 cm



H 28 cm

Attacco E27
Lampadine: 1 x 70 W max - E27 HGS

E27 screw.
Bulbs: 1 x 70 W max - E27 HGS



CL 608

Lampada da tavolo in metacrilato disponibile nel colore: cromolite.

Methacrylate table lamp available in: cromolite.

55



CL 486

Lampada da tavolo in metacrilato disponibile nel colore: TexturGold.

Methacrylate table lamp available in: TexturGold.

58



BABETTE

design by **Roberto Giacomucci**

CL 431

Lampada da tavolo con paralume conico in policarbonato antiriflesso con decoro nei colori: oro, nero, argento, bianco. Supporto in metallo cromato. Base in metacrilato bianco.

Polycarbonate table lamp with non-glare conical lampshade. Printed texture available in: gold, black, silver, white. Chromed stem. White methacrylate base.

32 05 33 10

∅ 30

Attacco E27

Lampadine: 1 x 70 W max - E27 HGS

E27 screw.

Bulbs: 1 x 70 W max - E27 HGS



H 56 cm



BABETTE

design by **Roberto Giacomucci**

CL 430

Lampada da tavolo con paralume conico in policarbonato antiriflesso con decoro nei colori: nero, bianco, oro, argento.

Polycarbonate table lamp with non-glare conical lampshade. Printed texture available in: black, white gold and silver.

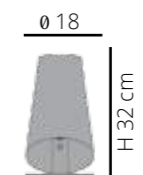

05 10 32 33

Attacco E27
Lampadine: 1 x 70
W max - E27 HGS

E27 screw.
Bulbs: 1 x 70
W max - E27 HGS

BOEMIA

design by **Roberto Giacomucci**

CL 818

Lumetto con paralume conico in policarbonato con decoro diamantato nei colori: bianco, rosso, verde e grigio.

Polycarbonate bedside lamp with conical lampshade. Texture available in: white, red, green and grey.

10 51 20 91

∅ 18



Attacco E27.
Lampadine: 1 x 70 W max - E27 HGS

E27 screw.
Bulbs: 1 x 70 W max - E27 HGS

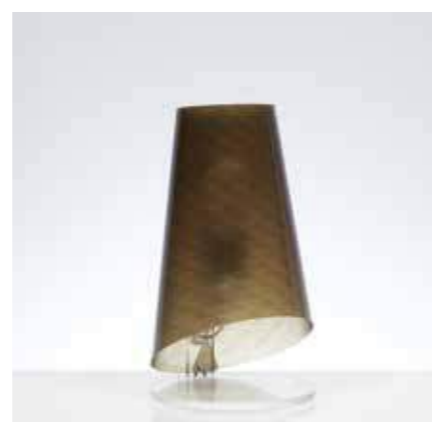

BOEMIA

design by **Roberto Giacomucci**

CL 820

Lampada da tavolo con paralume conico in policarbonato con decoro diamantato nei colori: bianco, rosso, verde e grigio.

*Polycarbonate table lamp with conical lampshade.
Texture available in: white, red, green and grey.*

10 51 20 91

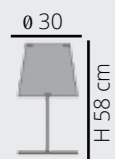

Attacco E27.
Lampadine: 1 x 70 W max - E27 HGS
E27 screw.
Bulbs: 1 x 70 W max - E27 HGS



BOEMIA

design by **Roberto Giacomucci**

CL 819

Lampada da tavolo con paralume conico in policarbonato con decoro diamantato nei colori: bianco, rosso, verde e grigio.

*Polycarbonate table lamp with conical lampshade.
Texture available in: white, red, green and grey.*

10 51 20 91

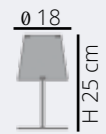

Attacco E14.
Lampadine: 1 x 28 W max - E14 FBT

E14 screw.
Bulbs: 1 x 28 W max - E14 FBT



PIXI

design by **Roberto Giacomucci**

CL 419

Lampada da tavolo con paralume conico in policarbonato antiriflesso con decoro nei colori: nero, bianco, oro, argento.

Polycarbonate table lamp with non-glare conical lampshade. Printed texture available in: black, white, gold and silver.

05 10 32 33

∅ 30



H 56 cm

Attacco E27
Bulbs: 1 x 70 W max - E27 HGS

E27 screw.
Bulbs: 1 x 70 W max - E27 HGS



PIXI

design by **Roberto Giacomucci**

CL 401

Lumetto con paralume conico in policarbonato antiriflesso con decoro nei colori: nero, bianco, oro, argento.

Polycarbonate bedside lamp with non-glare conical lampshade. Printed texture available in: black, white, gold and silver.

05 10 32 33

∅ 18



H 32 cm

Attacco E27
Lampadine: 1 x 70 W max - E27 HGS

E27 screw
Bulbs: 1 x 70 W max - E27 HGS



COTTON LIGHT

design by **Mammini Candido**

CL 1468

Abat-jour in sandylex pearl.

Bedside lamp in pearl sandylex.

15

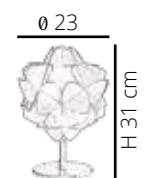

Attacco E14
Lampadine 1 x 28 W max - E 14 FBT

E14 screw.
Bulbs 1 x 28 W max - E14 FBT

CL 1469

*Abat-jour in sandylex pearl. Versione con decoro nei colori:
grigio e viola.*

*Bedside lamp in pearl sandylex. Texture available in grey and
purple*

29 91



COTTON LIGHT

design by **Mammini Candido**

CL1466

Lampada da tavolo in sandylex pearl.

Table lamp in pearl sandylex.

15

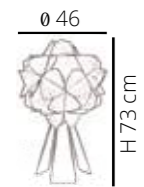

Attacco E 27
Lampadine: 1 x 70 W max - E27 HGS

E27 screw.
Bulbs: 1 x 70W max - E27 HGS

CL 1467

Lampada da tavolo in sandylex pearl.
Versione con decoro nei colori: grigio e viola.

Table lamp in pearl sandylex.
Texture available in: grey and purple.

29 91



EARLY

CL 1518

Lampada da tavolo touch multifunzione in ABS + gomma colore bianco.

Multifunctional touch table lamp in ABS + white rubber.

10

L 14,5 cm



FLORA

design by **Romeo Guaricci**

CL 1436

Lampada da tavolo in sandylex nel colore oropearl.

Table lamp in oropearl sandylex.

15

Ø 23



H 30 cm

Attacco E14.
Lampadine: 1x28 W max - E14 FBT

E14 screw.
Bulbs: 1x28 W max - E14 FBT



KIRA MINI

design by **Romeo Guaricci**

CL 1443

Lampada in PMMA cristalopal. Base in acciaio con fondo in metacrilato nero.

PMMA cristalopal table lamp. Base in steel.

14



Alimentata Strip led -IP20 - 12V - Tot.12 W - Luce naturale 4000 K + 5%, 15 IM/led. F.

Wiring strip led. IP20 - 12V - Tot.12W. 4000 K + 5%, 15 IM/led.



KIRA SMALL

design by Romeo Guaricci

CL 1442

Lampada in PMMA cristalopal . Base in acciaio con fondo in metacrilato nero.

PMMA cristalopal lamp. Base in steel.

14



Alimentata Strip led -IP20 - 12V - Tot.24 W - Luce naturale 4000 K + 5%, 15 IM/led.

Wiring strip led. IP20 - 12V - Tot.24W. 4000 K + 5%, 15 IM/led.



NEVEA

design by **Melissa Giacchi**

CL1461

Lampada da tavolo in polipropilene bianco con contenitore.

Table lamp in pearl white polypropylene with pen holder.

15

L 16 cm



Attacco E14.
Lampadine: 1x28 W max - E14 HGS

E14 screw.
Bulb: 1x28 W max E14 - HGS



NUCLEA

design by Roberto Giacomucci

Ø 40 cm



H 58 cm

Attacco E27.
Lampadine: 1 x 70 W max - E27 HGS

E27 screw.
Bulb: 1x70 W max E27 - HGS

CL 490

Lampada da tavolo in metacrilato disponibile nei colori: satinato, rosso, fumé e spectrall.

Methacrylate table lamp available in: opaline white, red, smoked grey and spectrall.

12 51 98 88



CL 646 cromolite

55



CL 491 TexturGold

58



CL 872

Versione natural opal con decoro nuance nei colori: rosso e grigio.

Natural opal version available in: red or grey.

91 53



RIGATONE

design by **Roberto Giacomucci**

CL 894

Lampada da tavolo. Paralume cilindrico in polipropilene bianco perla con decoro fili. Struttura in metacrilato finitura spectrall e satinato.

Table lamp. White pearl cylindrical poliporopylene lampshade with thread texture. Methacrylate structure with spectrall and opaline white finish.

89

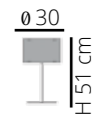

Attacco E27.
Lampadine: 1 x 70 W max - E27 HGS

E27 screw.
Bulbs: 1 x 70 W max - E27 HGS



CL 895

Lumetto. Paralume cilindrico in polipropilene bianco perla con decoro fili. Struttura in metacrilato finitura spectrall e satinato.

Bedside lamp. White pearl cylindrical poliporopylene lampshade with thread texture. Methacrylate structure with spectrall and opaline white finish.

89



Attacco E14.
Lampadine: 1 x 15 W max - E14 FBT

E14 screw.
Bulbs: 1 x 15 W max - E14 FBT



SIGNORAPINA

design by UTE

CL1453

Lampada da tavolo in sandylex pearl. Base e struttura in metallo verniciato. Disco copribase in acrilico cromo e oro.

Table lamp in pearl sandylex. Base in chrome and gold acrilic.

55 57

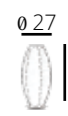

Attacco E14
2 Lampadine: 2 x 42 W max-E14 FBT

E14 screw.
Bulbs: 2 x 42 W max E14 FBT



SNAKE

CL1519

Lampada da tavolo o portatile in ABS + gomma colore bianco.

Touch table lamp in ABS + white rubber.

10

L 10 cm
H 30 cm



TATA

design by **Roberto Giacomucci**

CL 550

Lampada da tavolo realizzata in materiale acrilico. Disponibile nei colori: trasparente, verde, rosso, blu e fumé.

Table lamp in acrylic material. Available in: transparent, green, red, blue and smoked grey.

11 20 51 61 91

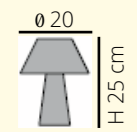

Lampadina inclusa: 1 x 5W led G9

Bulb included: 1 x 5W led G9



TRUCIOLO

design by **Roberto Giacomucci**

CL 190

Lampada da tavolo con paralume cilindrico in metacrilato opal diffusore. Base in metacrilato disponibile nei colori: nero, trasparente, satinato.

Table lamp. Methacrylate lampshade, opal diffuser shade. Methacrylate base available in: transparent, black and opaline white.

05 11 12

∅ 26,5



H 60 cm

Attacco E27.
Lampadine: 1 x 70 W max - E27 HGS

E27 screw.
Bulbs: 1 x 70 W max - E27 HGS



TRUCIOLO

design by **Roberto Giacomucci**

CL 189

Lampada da tavolo con paralume cilindrico in metacrilato opal diffusore. Base in metacrilato disponibile nei colori: nero, trasparente, satinato.

Table lamp. Methacrylate lampshade, opal diffuser shade. Methacrylate base available in: transparent, black and opaline white.

05 11 12



Ø 18,5



Attacco E27.
Lampadine: 1 x 70 W max - E27 HGS

E27 screw.
Bulbs: 1 x 70 W max - E27 HGS



BABETTE

design by **Roberto Giacomucci**

CL 432

Lampada da terra con paralume conico in policarbonato antiriflesso decorato con texture nei colori: nero, bianco, oro, argento.

Polycarbonate floor lamp with non-glare conical lampshade. Printed texture in black, white, gold and silver.

05 10 32 33

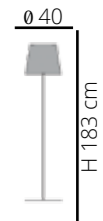

Attacco E27
Lampadine: 1 x 70 W max - E27 HGS

E27 screw.
Bulbs: 1 x 70 W max - E27 HGS



BOEMIA

design by Roberto Giacomucci

CL 821

Lampada da terra con paralume conico in policarbonato con decoro diamantato nei colori: bianco, rosso, verde e grigio.

Polycarbonate floor lamp with conical lampshade.
Texture available in: white, red, green and grey.

10 51 20 91

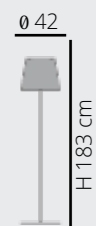

Attacco E27.
Lampadine: 1 x 70 W max - E27 HGS

E27 screw.
Bulbs: 1 x 70 W max - E27 HGS



PIXI

design by **Roberto Giacomucci**

CL 402

Lampada da terra con paralume conico in policarbonato antiriflesso con decoro nei colori: nero, bianco, oro, argento.

Polycarbonate floor lamp with non-glare conical lampshade. Printed texture available in: black, white, gold and silver.

05 10 32 33

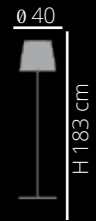

Attacco E27
Bulbs: 1 x 70 W max - E27 HGS

E27 screw
Bulbs: 1 x 70 W max - E27 HGS



CLYDE

design by **Romeo Guaricci**

CL 1454

Piantana in sandylex pearl. Base e struttura in metallo verniciato. Disco copribase in acrilik cromo e oro.

Floor lamp in pearl sandylex. Metal support. Base in chrome and gold acrilik.

55 57

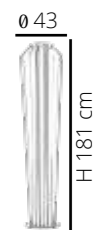

Attacco E27
Lampadine: 4 x 42 W max - E27 HGS

E27 screw.
Bulbs: 4 x 42 W max E27 HGS



DIVA

design by **Roberto Giacomucci**

CL 435

Lampada da terra 2 luci in polipropilene bianco perla.

Floor lamp in white pearl polypropylene.

10

∅ 37



H 140 cm

Attacco E27

Lampadine: 2 x 70 W max - E27 HGS

E27 screw.

Bulbs: 2 x 70 W max - E27 HGS



FLORA

design by **Romeo Guaricci**

CL 1431

Lampada da terra con paralume in sandylex nel colore oropearl.

Floor lamp with oropearl sandylex lampshade.

15

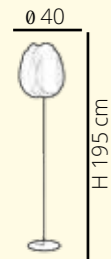

Attacco E27.
Lampadine 1 x 70 W max - E27 HGS

E27 screw.
Bulbs: 1 x 70 W max - E27 HGS



KIRA LARGE

design by Romeo Guaricci

CL 1441

Lampada in PMMA cristalopal. Base in acciaio con fondo in metacrilato nero.

PMMA cristalopal floor lamp. Base in steel.

14

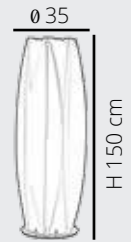

Alimentata strip led -IP20 - 12V - Tot.60 W - Luce naturale 4000 K + 5%, 15 IM/led.

Wiring strip led. IP20 - 12V - Tot.60W. 4000 K + 5%, 15 IM/led.



NUCLEA

design by **Roberto Giacomucci**

CL 493

Lampada da terra in metacrilato disponibile nei colori: satinato, rosso, fumé e spectrall.

Methacrylate floor lamp available in: opaline white, red, smoked grey and spectrall.

12 51 98 88

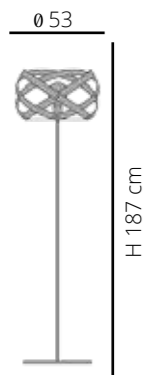

Attacco E27.
Lampadine: 1 x 70 W max - E27 HGS

E27 screw.
Bulbs: 1 x 70 W max - E27 HGS

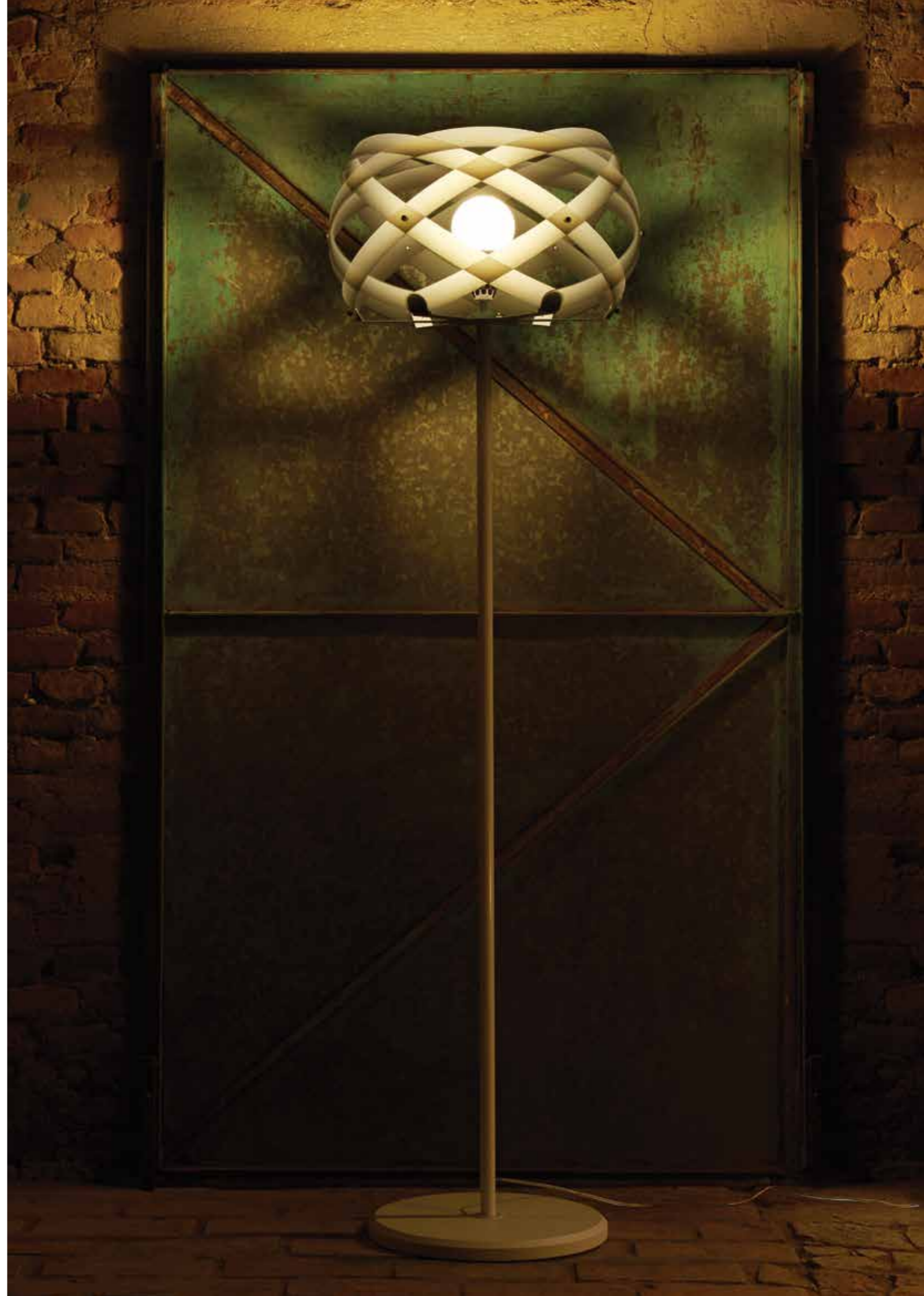

NUCLEA

design by **Roberto Giacomucci**

CL 647

Lampada da terra in metacrilato disponibile nel colore: cromolite.

Methacrylate floor lamp available in: cromolite.



55

CL 494

Lampada da terra in metacrilato disponibile nel colore: TexturGold.

Methacrylate floor lamp available in: TexturGold.



58

CL 873

Versione natural opal con decoro nuance nei colori: rosso e grigio.

Natural opal version available in: red or grey.



53 91



RIGATONE

design by **Roberto Giacomucci**

CL 896

Lampada da terra. Paralume cilindrico in polipropilene bianco perla con decoro fili. Struttura in metacrilato finitura spectrall e satinato.

Floor lamp. White pearl cylindrical poliporopylene lampshade with thread texture. Methacrylate structure with spectrall and opaline white finish.

89

Ø 45



H 181 cm



Attacco E27.

Lampadine: 1 x 70 W max - E27 HGS

E27 screw.

Bulbs: 1 x 70 W max - E27 HGS



SIGNORAPINA LARGE

design by UTE

CL1451

Piantana in sandylex pearl. Base e struttura in metallo verniciato. Disco copribase in acirek cromo e oro.

Floor lamp in pearl sandylex. Base in chrome and gold acirek.

55 57

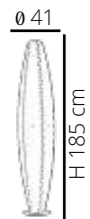

Attacco E27

Lampadine: 4 x 42 W max-E27 HGS

E27 screw

Bulbs: 4 x 42 W max E27 HGS



SIGNORAPINA MEDIUM

design by UTE

CL1452

*Piantana in sandylex pearl. Base e struttura in metallo verniciato.
Disco copribase in acrilik cromo e oro.*

Floor lamp in pearl sandylex. Base in chrome and gold acrilik.

55 57

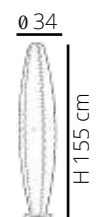

Attacco E27
3 Lampadine: 3 x 53 W max-E27 HGS

E27 screw
Bulbs: 3 x 53 W max E27 HGS

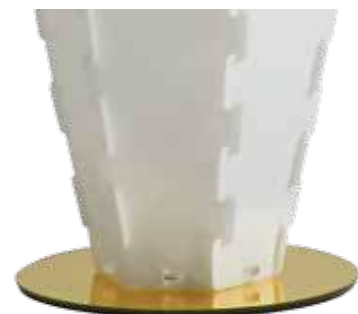

RELOAD

design by **Roberto Giacomucci**

CL 408

Lampada da terra con paralume in materiale plastico termofuso di cui una parte derivante dal processo di riciclo. Disponibile nei colori bianco o multicolor.

Floor lamp partially made from recycled plastic. Available in white or multicolour.

10 99

Ø 48



H 52 cm

Attacco E27.
Lampadine: 1 x 70 W max - E27 HGS

E27 screw.
Bulbs: 1 x 70 W max - E27 HGS



ALLEGRETTA

design by **Romeo Guaricci**

CL 1406

Applique in metacrilato disponibile nei colori: satinato, spectrall e fumé.

Methacrylate wall lamp available in: opaline white, spectrall and smoked grey.

12 88 98

Ø 24



Attacco E14.
Lampadine: 1 x 15 W max - E14 FBT

E14 screw.
Bulbs: 1 x 15 W max-E14 FBT



CL 1407

Applique in metacrilato disponibile nel colore: texturgold.

Methacrylate wall lamp available in: texturgold.

58



ANTHEA

design by **Roberto Giacomucci**

CL 476

Applique in metacrilato disponibile nei colori: trasparente, satinato, rosso, spectrall e fumé.

Methacrylate wall lamp available in: transparent, opaline white, red, spectrall and smoked grey.

11 12 51 88 98

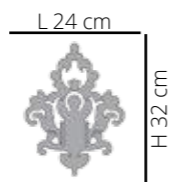

Attacco E27
Lampadine: 1 x 70 W max - E27 HGS

E27 screw
Bulbs: 1 x 70 W max-E27 HGS

CL 477

Applique in metacrilato disponibile nel colore: texturgold.

Methacrylate wall lamp available in: texturgold.

58



CL 609

Applique in metacrilato disponibile nel colore: cromolite.

Methacrylate wall lamp available in: cromolite.

55

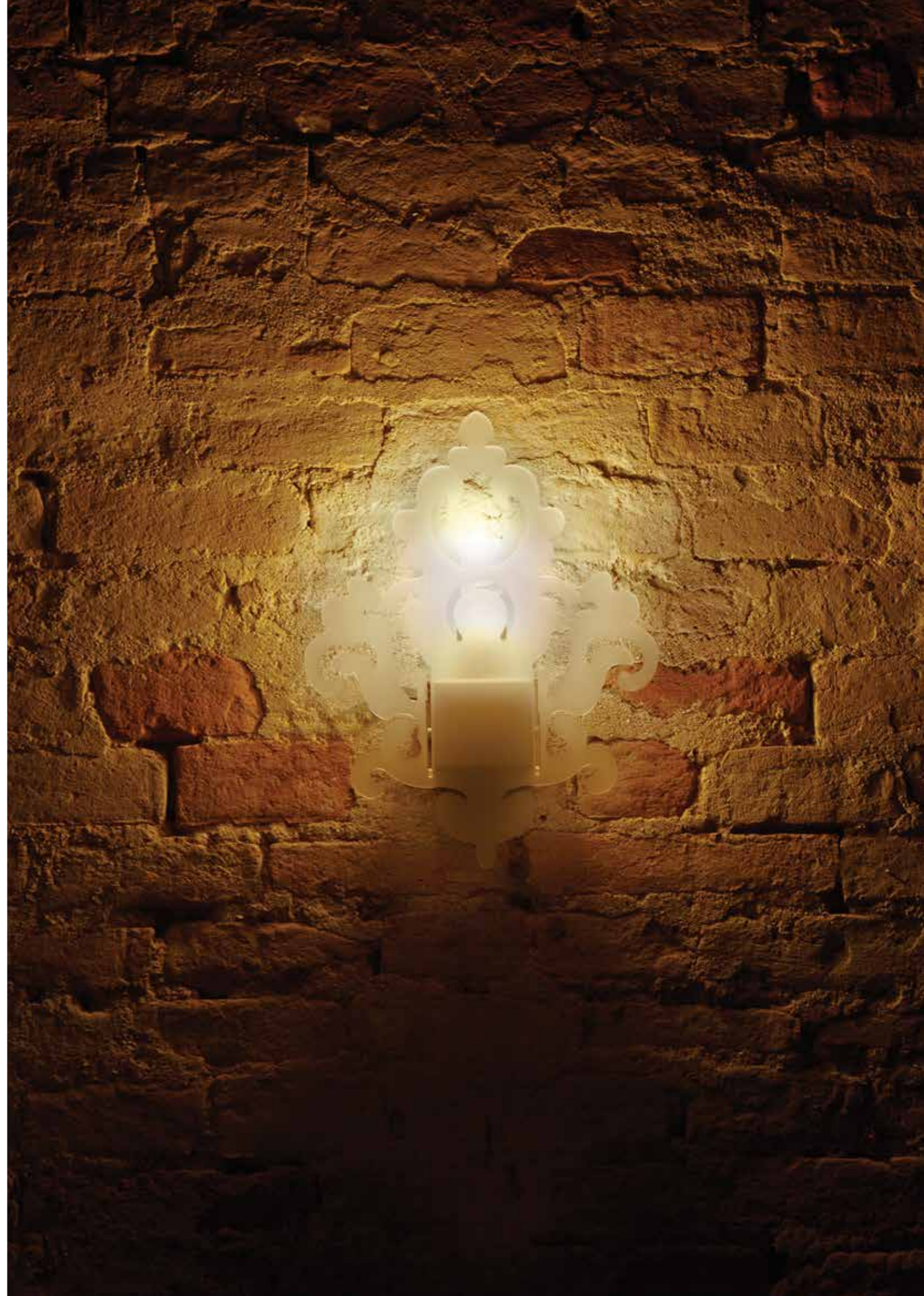

CAMILLA

design by **Walter Sbicca**

CL1490

*Applique in metacrilato sp. 8 mm e paralume in sandylex.
Disponibile nei colori: bianco e nero.*

*Methacrylate wall lamp thickness 8 mm with sandylex lampshade
available in white and black.*

10 05

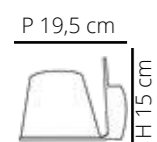

Lampadine: 1 x 70 W max - E27 HGS

Bulbs: 1 x 70 W max - E27 HGS



COTTON LIGHT

design by Mammini Candido

CL 1470

Applique in sandylex pearl.

Wall lamp in pearl sandylex.



15

P 18 cm



Attacco E27
Lampadine: 1 x 70W max - E27 HGS

E27 screw
Bulbs: 1 x 70W max - E27 HGS

CL1471

Applique in sandylex pearl. Versione con decoro nei colori: grigio e viola.

Wall lamp in pearl sandylex. Texture available in grey and purple.



91 29

P 18 cm



Attacco E27
Lampadine: 1 x 70W max - E27 HGS

E27 screw
Bulbs: 1 x 70W max - E27 HGS



DIDODADO

design by **Roberto Giacomucci**

CL 446

Applique con paralume in PMMA disponibile nei seguenti colori: satinato, fumé e spectrall.

Wall lamp with PMMA lampshade available in: opaline white, smoked grey and spectrall.

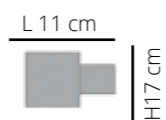

Attacco E27.
Lampadine: 1 x 42 W max - E27 HGS

E27 screw.
Bulbs: 1 x 42 W max - E27 HGS

12 98 88



CL 411

Applique con paralume in PMMA disponibile nel colore: texturgold.

Wall lamp with PMMA lampshade available in: texturgold.

58



CL 627

Applique con paralume in PMMA disponibile nel colore: cromolite.

Wall lamp with PMMA lampshade available in: cromolite.

55



GEMMA

design by **Romeo Guaricci**

CL 1488

*Applique con calotta in PMMA opal diffusore.
Fregio in sandylex pearl.*

Wall lamp in pearl white PMMA.

15



P 13 cm



Ø 28 cm

Attacco E27
Lampadine: 1 x 70W max - E27 HGS

E27 screw
Bulbs: 1 x 70W max - E27 HGS

CL 1489

*Applique con calotta in PMMA opal diffusore. Fregio in sandylex
pearl. Versione con decoro nei colori:
grigio e viola.*

*Wall lamp in pearl white PMMA. Texture available in:
purple or grey sandylex.*

91 29



P 13 cm



Ø 28 cm

Attacco E27
Lampadine: 1 x 70W max - E27 HGS

E27 screw
Bulbs: 1 x 70W max - E27 HGS



RIGATONE

design by **Roberto Giacomucci**

CL 892

Applique a 2 luci con paralume in polipropilene bianco perla con decoro fili.

2 light wall lamp. White pearl polypropylene lampshade with thread texture.

89

L 10 cm



Attacco E14
Lampadine: 2 x 15 W max - E14 FBT

E14 screw
Bulbs: 2 x 15 W max - E14 FBT



CL 893

Applique a 2 luci con paralume in polipropilene bianco perla con decoro fili.

2 light wall lamp. White pearl polypropylene lampshade with thread texture.

89

L 18 cm



Attacco E14
Lampadine: 2 x 15 W max - E14 FBT

E14 screw
Bulbs: 2 x 15 W max - E14 FBT



DAMA

design by UTE



CL 1510

Applique 2 luci in acrilico. Disponibile nei colori kristalcromo, kristaloro e kristalbronzo.

Wall lamp with 2 lights available in: kristalchrome, kristalgold and kristalbronze.



Attacchi GX 53-1
Lampadine: 2 X 7 W max- GX53-1 FB
Lampadine: 2 X 9 W max- GX 53-1 led

Bulbs: 2 X 7 W max- GX53-1 FB
Bulbs: 2 X 9 W max- GX 53-1 led

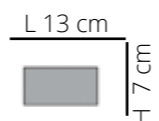

CL 1509

Applique 1 luce in acrilico. Disponibile nei colori kristalcromo, kristaloro e kristalbronzo.

Wall lamp available in: kristalchrome, kristalgold and kristalbronze.



A Attacchi GX 53-1
Lampadine: 1 X 7 W max- GX53-1 FB
Lampadine: 1 X 9 W max- GX 53-1 led

Bulbs: 1 X 7 W max- GX53-1 FB
Bulbs: 1 X 9 W max- GX 53-1 led

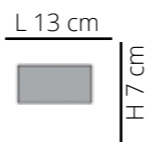

DOMINO

design by **Roberto Giacomucci**

CL 587

*Applique 2 luci in metacrilato bicolore bianco e trasparente.
Struttura in metallo bianco verniciato.*

*Wall lamp with 2 lights. Structure in bicolor methacrylate,
white and transparent.*

10



*Attacchi GX 53-1
Lampadine: 2 X 7 W max- GX53-1 FB
Lampadine: 2 X 9 W max- GX 53-1 led*

*Bulbs: 2 X 7 W max- GX53-1 FB
Bulbs: 2 X 9 W max- GX 53-1 led*

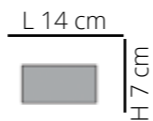

CL 577

*Applique in metacrilato bicolore bianco e trasparente.
Struttura in metallo bianco verniciato.*

*Wall lamp. Structure in bicolor methacrylate,
white and transparent.*

10



*Attacchi GX 53-1
Lampadine: 1 X 7 W max- GX53-1 FB
Lampadine: 1 X 9 W max- GX 53-1 led*

*Bulbs: 1 X 7 W max- GX53-1 FB
Bulbs: 1 X 9 W max- GX 53-1 led*

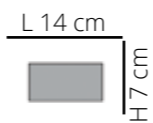

ARALIA

design by **Roberto Giacomucci**

CL 574

Plafoniera in metacrilato disponibile nei colori: satinato, rosso, spectrall e fumé.

Methacrylate ceiling lamp available in: opaline white, red, cromolite, spectrall and smoked grey.

12 51 88 98

Ø 53 cm



H 23 cm

Attacco E27.
Lampadine: 1 x 42 W max - E27 HGS

E27 screw.
Bulbs: 1 x 42 W max - E27 HGS

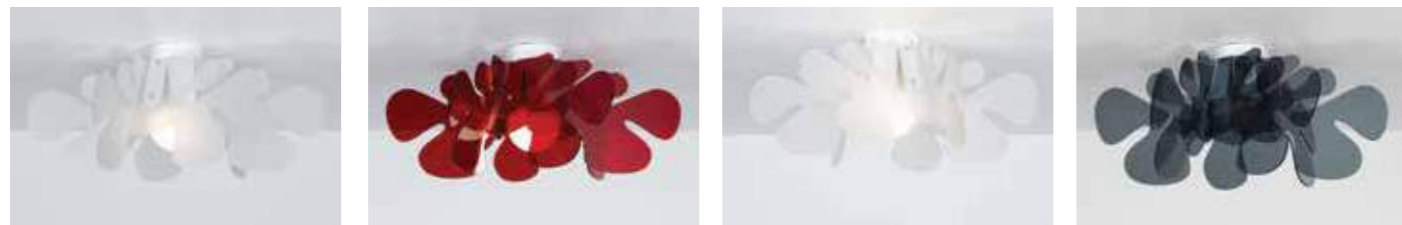

CL 613

Plafoniera in metacrilato disponibile nel colore: cromolite.

Methacrylate ceiling lamp available in: cromolite.

55



CL 575

Plafoniera in metacrilato disponibile nel colore: texturgold.

Methacrylate ceiling lamp available in: texturgold.

58



CL 864 nuance

Plafoniera in metacrilato disponibile con decoro nuance nei colori rosso e grigio.

Methacrylate ceiling lamp. Natural opal version in red and grey.

53 91

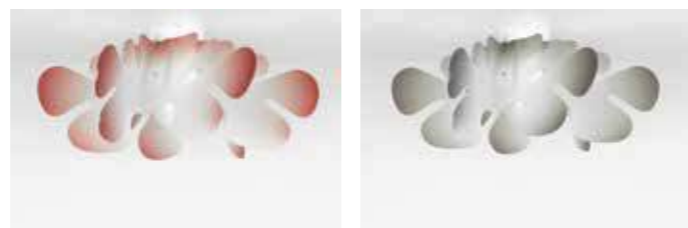

CIGNO

design by Romeo Guaricci

CL 1412

Plafoniera in metacrilato disponibile nei colori satinato, spectrall e fumé.

Methacrylate ceiling lamp available in: opaline white, spectrall and smoked grey.

12 88 98

Ø 52 cm



H 34 cm

Attacco E27.

Lampadine: 1 x 42 W max - E27 HGS

E27 screw.

Bulbs: 1 x 42 W max - E27 HGS

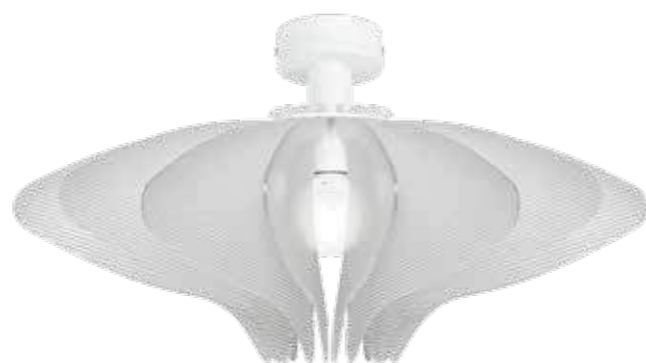

CL 1413

Plafoniera in metacrilato disponibile nel colore TexturGold.

Methacrylate ceiling lamp available in: TexturGold.

58



DIDODADO

design by **Roberto Giacomucci**

CL 448

Plafoniera barra a quattro elementi con paralume in PMMA disponibile nei seguenti colori: satinato, fumé e spectrall.

Ceiling lamp with PMMA lampshade available in: opaline white, smoked grey and spectrall.

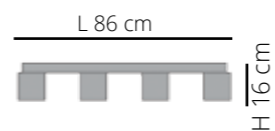

Attacco E27.
Lampadine: 4 x 42 W max - E27 HGS

E27 screw.
Bulbs: 4 x 42 W max - E27 HGS

12 98 88



CL 413

Plafoniera barra a quattro elementi con paralume in PMMA disponibile nel colore: texturgold.

Ceiling lamp with PMMA lampshade available in: texturgold.

58



CL 629

Plafoniera barra a quattro elementi con paralume in PMMA disponibile nel colore: cromolite.

Ceiling lamp with PMMA lampshade available in: cromolite.

55



DIDODADO

design by **Roberto Giacomucci**

CL 445

Spot con paralume in PMMA disponibile nei seguenti colori:
satinato, fumé e spectrall.

Spot with PMMA lampshade available in:
opaline white, smoked grey and spectrall.

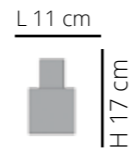

Attacco E27.
Lampadine: 1 x 42 W max - E27 HGS

E27 screw.
Bulbs: 1 x 42 W max - E27 HGS

12 98 88



CL 410

Spot con paralume in PMMA disponibile nel colore: texturgold.

Spot with PMMA lampshade available in: texturgold.

58



CL 626

Spot con paralume in PMMA disponibile nel colore: cromolite.

Spot with PMMA lampshade available in: cromolite.

55



GEMMA

design by Romeo Guaricci

CL 1482

Plafoniera 4 luci con calotta in PMMA opal diffusore. Fregio in sandylex pearl.

4 light ceiling lamp in pearl white PMMA.



15

Ø 70 cm



H 22 cm

Attacco E27

Lampadine: 4 x 42 W max - E27 HG

E27 screw

Bulbs: 4 x 42 W max - E27 HGS

CL 1483

Plafoniera 4 luci con calotta in PMMA opal diffusore. Fregio in sandylex pearl, versione con decoro nei colori: grigio e viola.

4 light ceiling lamp in pearl white PMMA. Texture available in: purple or grey sandylex



91 29



GEMMA

design by Romeo Guaricci

CL 1484

Plafoniera 3 luci con calotta in PMMA opal diffusore. Fregio in sandylex pearl.

3 light ceiling lamp in pearl white PMMA.

15



Ø 51 cm



H 20 cm

Attacco E27
Lampadine: 3 x 42 W max - E27 HG
E27 screw
Bulbs: 3 x 42 W max - E27 HGS

CL 1485

Plafoniera 3 luci con calotta in PMMA opal diffusore. Fregio in sandylex pearl. Versione con decoro nei colori: grigio e viola.

3 light ceiling lamp in pearl white PMMA. Texture available in: purple or grey sandylex.

91 29



GEMMA

design by Romeo Guaricci

CL 1486

Plafoniera 2 luci con calotta in PMMA opal diffusore. Fregio in sandylex pearl.

2 light ceiling lamp in pearl white PMMA.

15



Ø 43 cm



H 18 cm

Attacco E27
Lampadine: 2 x 42 W max - E27 HG
E27 screw.
Bulbs: 2 x 42 W max - E27 HGS

CL 1487

Plafoniera 2 luci con calotta in PMMA opal diffusore. Fregio in sandylex pearl. Versione con decoro nei colori: grigio e viola.

2 light ceiling lamp in pearl white PMMA. Texture available in: purple or grey sandylex.

91 29



NUCLEA

design by Roberto Giacomucci

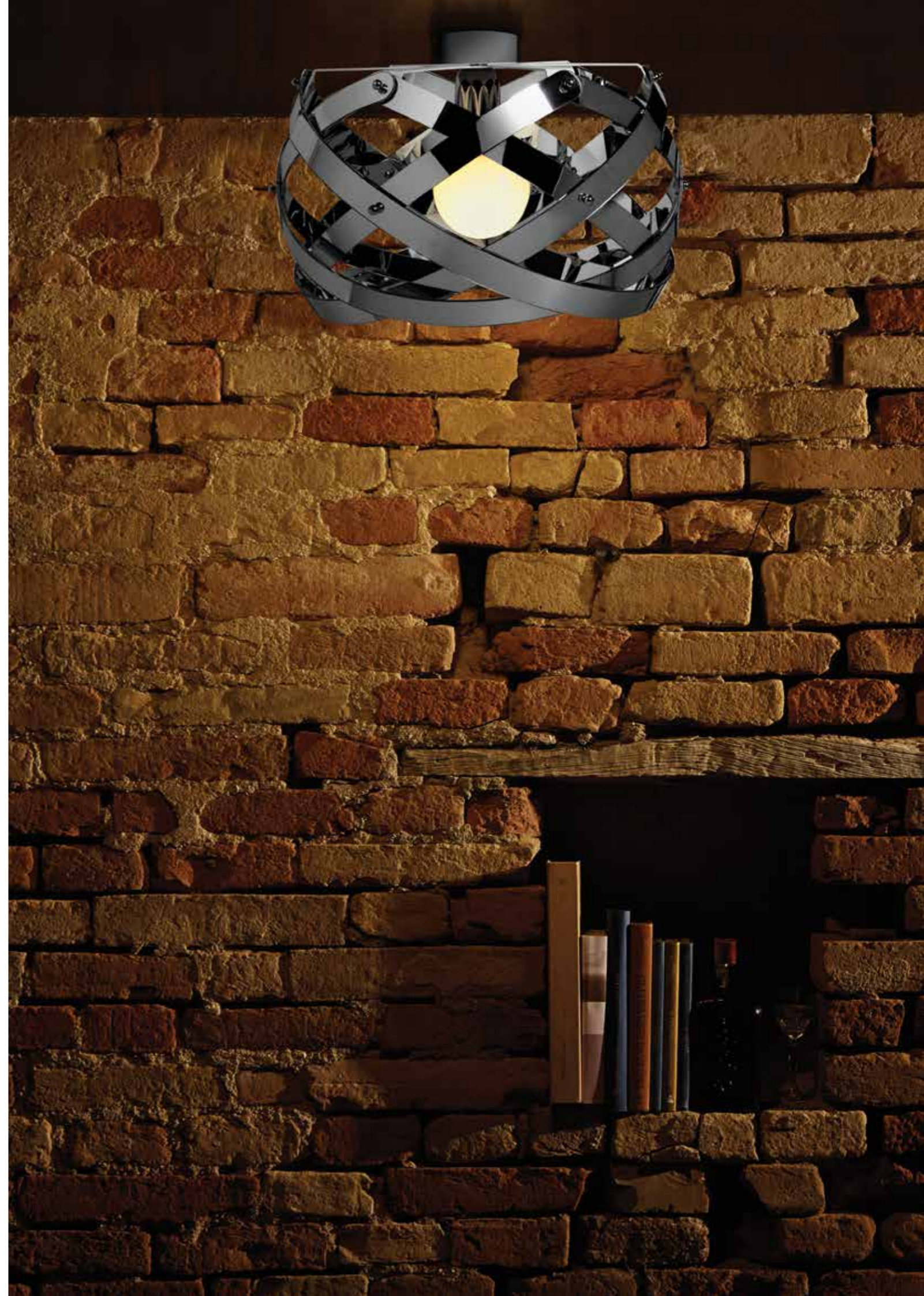

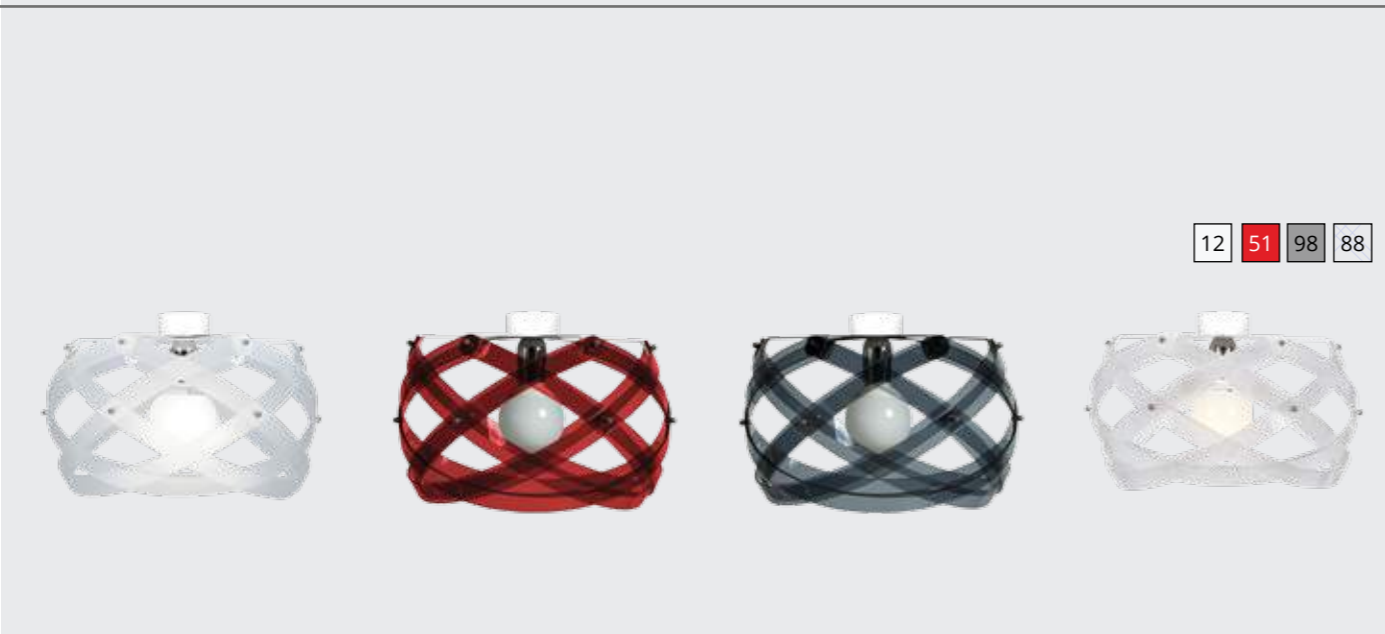

12 51 98 88

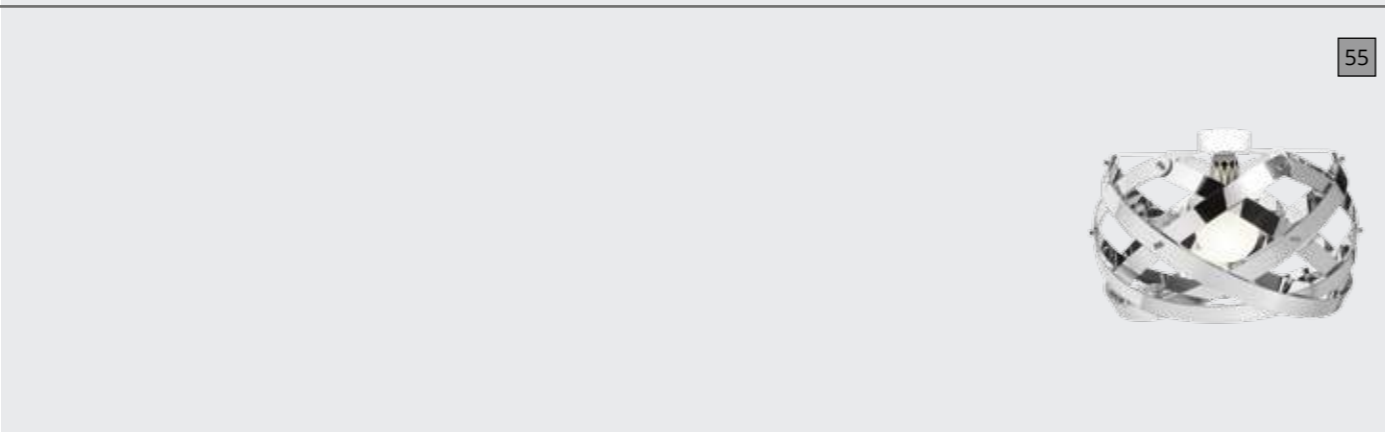

55

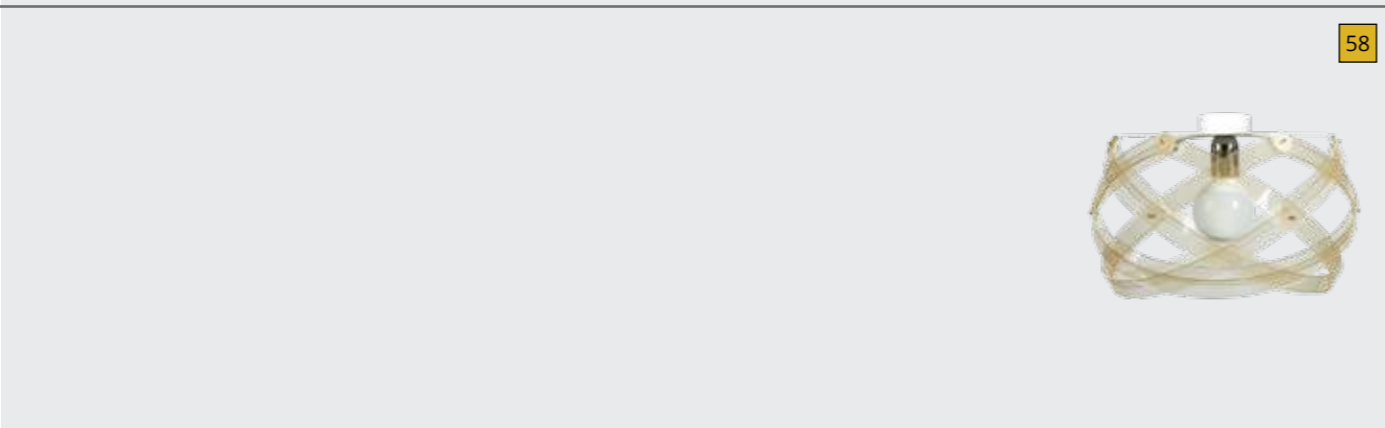

58

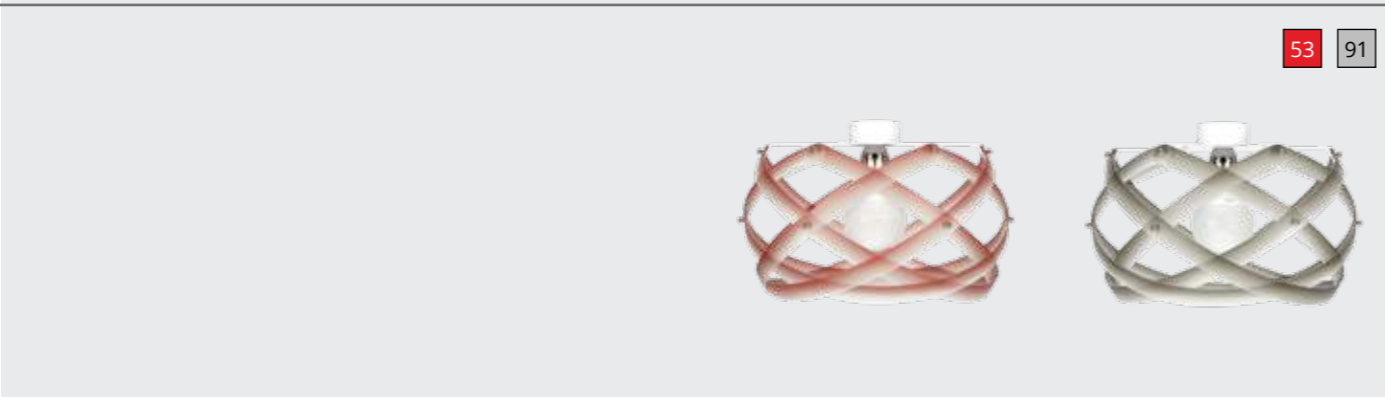

53 91

design by **Roberto Giacomucci**

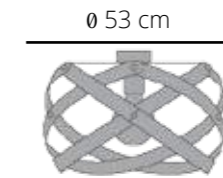

Attacco E27.
Lampadine: 1 x 70 W max - E27 HGS
E27 screw.
Bulbs: 1 x 70 W max - E27 HGS

Plafoniera in metacrilato disponibile nei colori:
Methacrylate ceiling lamp available in:

CL 454 satinato, rosso, fumé e spectrall.
opaline white, red, smoked grey and spectrall. 12 51 88 98

CL 645 cromolite 55

CL 455 texturgold 58

CL 871 decoro nuance nei colori: rosso e grigio.
Natural opal version available in: red or grey. 53 91

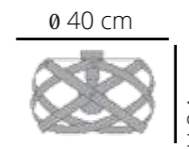

Attacco E27.
Lampadine: 1 x 70 W max - E27 HGS
E27 screw.
Bulbs: 1 x 70 W max - E27 HGS

Plafoniera in metacrilato disponibile nei colori:
Methacrylate ceiling lamp available in:

CL 452 satinato, rosso, fumé e spectrall.
opaline white, red, smoked grey and spectrall. 12 51 88 98

CL 644 cromolite 55

CL 453 texturgold 58

CL 870 decoro nuance nei colori: rosso e grigio.
Natural opal version available in: red or grey. 53 91

NUVOLA

design by **Roberto Giacomucci**

CL 591

Plafoniera in metacrilato, disponibile nei colori: satinato, rosso, fumé e spectrall.

Methacrylate ceiling lamp available in: opaline white, red, smoked grey, and spectrall.

12 51 98 88

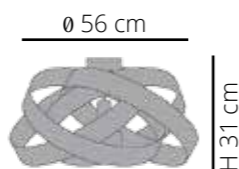
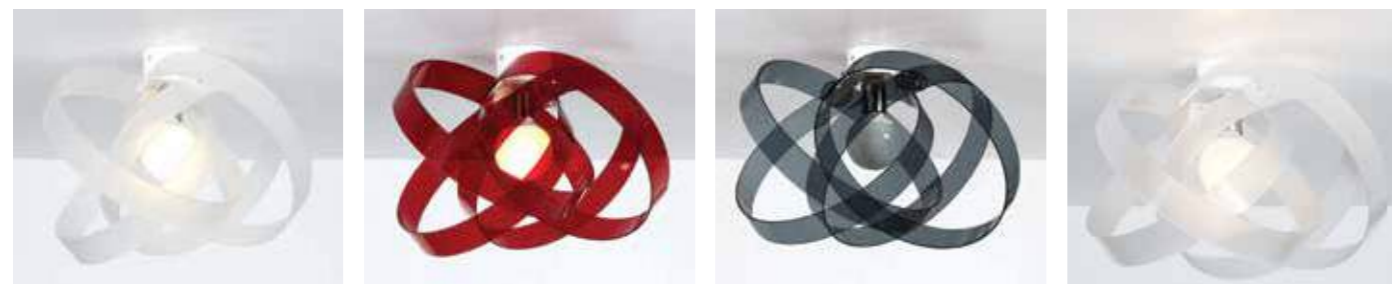

Attacco E27.
Lampadine : 1 x 70 W max - E27 HGS

E27 screw.
Bulbs: 1 x 70 W max - E27 HGS

CL 592

Plafoniera in metacrilato, disponibile nel colore: oro e cromolite. (44X44XH27 SOLO CROMOLITE)

Methacrylate ceiling lamp available in: gold and cromolite. (44X44XH27 ONLY CROMOLITE)

57 55



CL 693

Plafoniera in metacrilato, disponibile nel colore: texturgold.

Methacrylate ceiling lamp available in: texturgold.

58



CL 879

Plafoniera in metacrilato, disponibile nella versione natural opal con decoro nuance nei colori: rosso e grigio.

Methacrylate ceiling lamp. Natural opal version available in: red or grey.

53 91



CL 881

Plafoniera in metacrilato, disponibile nella versione bicolor: cromolite/satinato - gold/satinato. (54X44XH33 SOLO BICOLOR CROMOLITE)

Methacrylate ceiling lamp. Bicolor version available in: cromolite/opaline white - gold/opaline white. (54X44XH33 ONLY BICOLOR CROMOLITE)

95 97

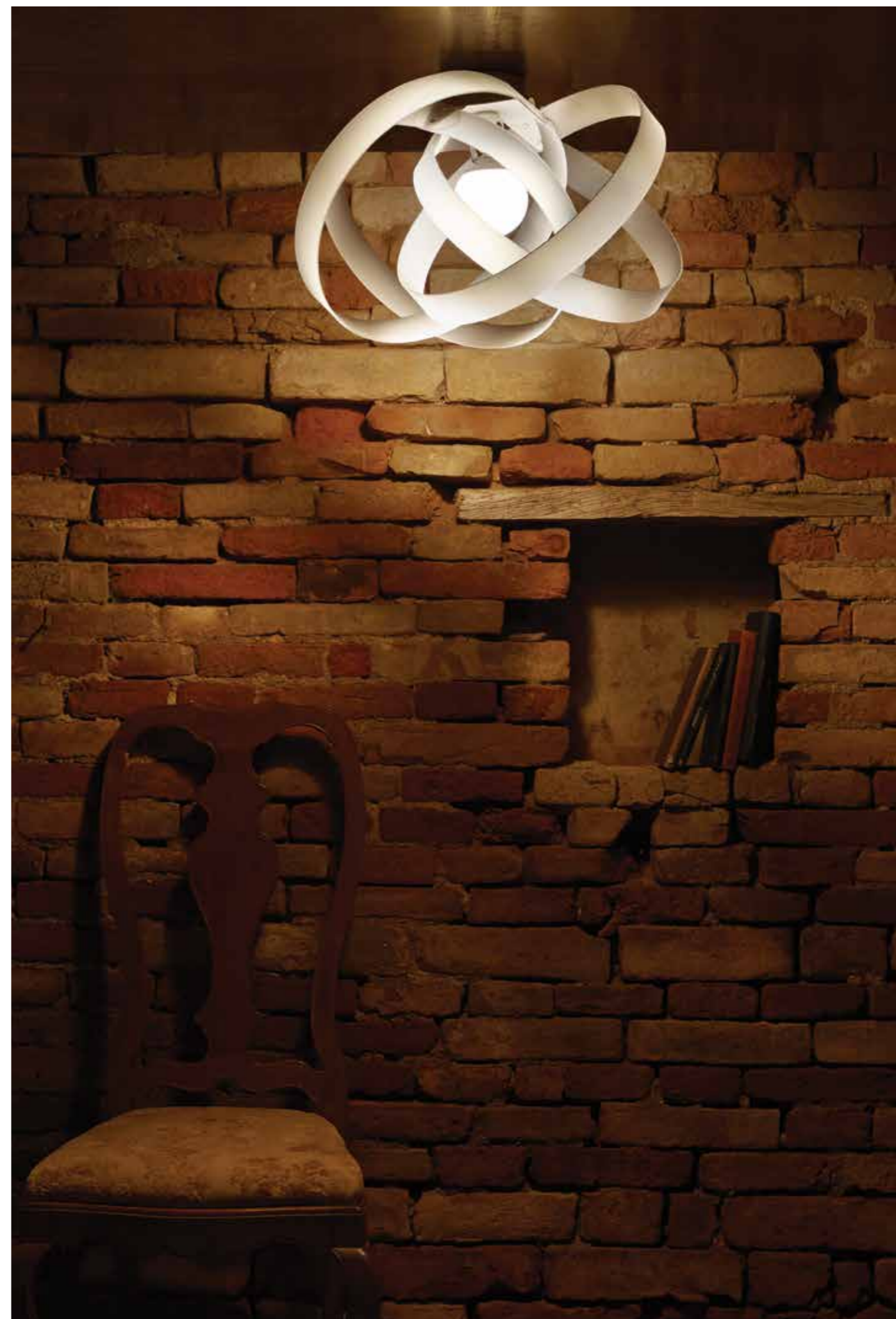

RELOAD

design by **Roberto Giacomucci**

CL 407

Plafoniera con paralume in materiale plastico termofuso di cui una parte derivante dal processo di riciclo. Disponibile nei colori bianco o multicolor.

Ceiling lamp partially made from recycled plastic. Available in white or multicolour.

10 99

Ø 48 cm



Attacco E27.
Lampadine: 1 x 70 W max - E27 HGS

E27 screw.
Bulbs: 1 x 70 W max - E27 HGS

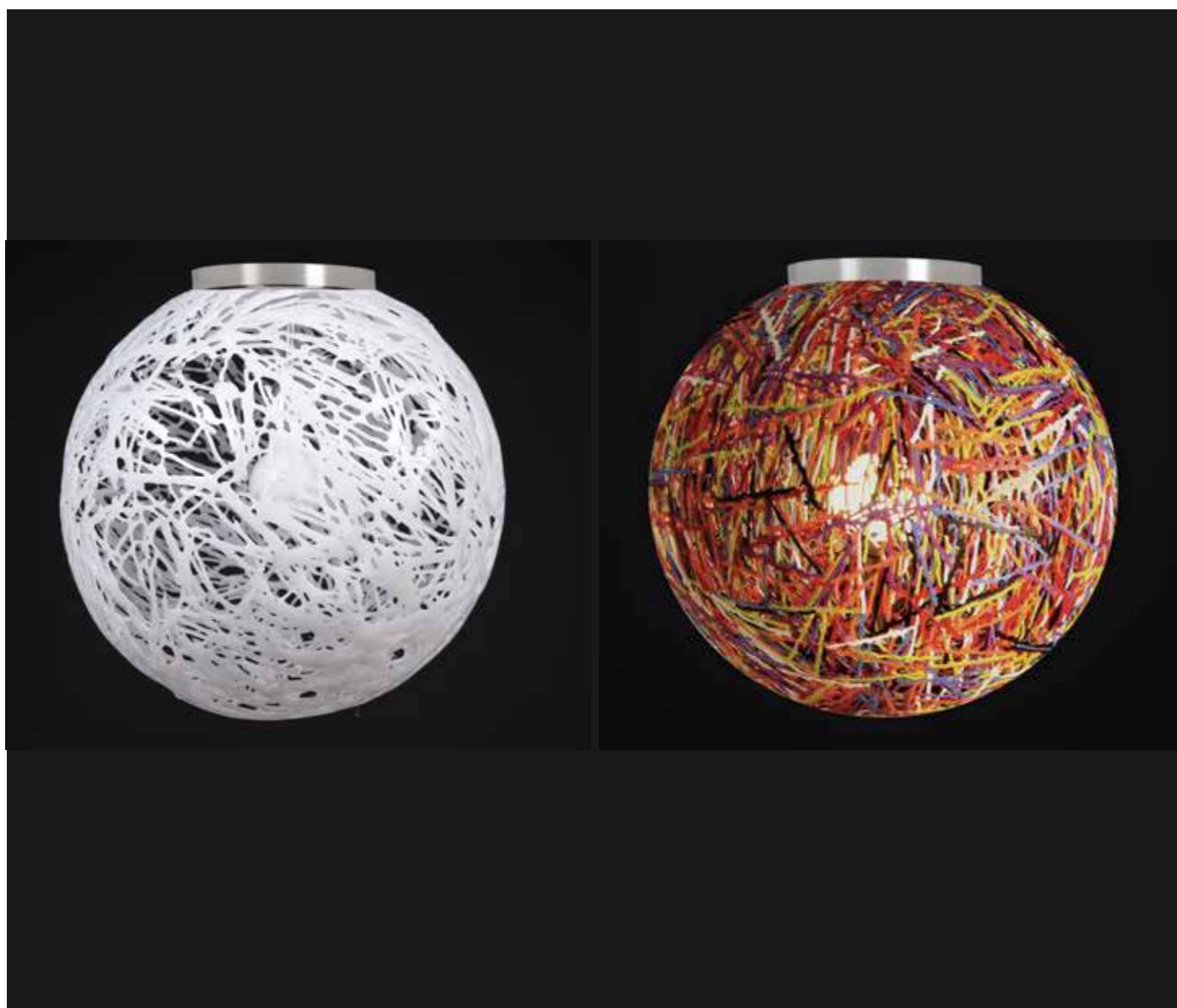

RIGATONE

design by **Roberto Giacomucci**

CL 889

Plafoniera con paralume cilindrico in polipropilene bianco perla con decoro fili. Struttura in metacrilato finitura spectrall e satinato.

Ceiling lamp. White pearl cylindrical polypropylene lampshade with thread texture. Methacrylate structure in spectrall and opaline white finish.

89

Attacco E27.
Lampadine: 1 x 42 W max - E27 HGS

Ø 30 cm

H 14,4 cm

E27 screw.
Bulbs: 1 x 70 W max - E27 HGS



CL 890

Plafoniera a 2 luci con paralume cilindrico in polipropilene bianco perla con decoro fili. Struttura in metacrilato finitura spectrall e satinato.

2 light ceiling lamp. White pearl cylindrical polypropylene lampshade and thread texture. Methacrylate structure in spectrall and opaline white finish.

89

Attacco E27.
Lampadine: 2 x 42 W max - E27 HGS

Ø 45 cm

H 14,4 cm

E27 screw.
Bulbs: 2 x 42 W max - E27 HGS



CL 891

Plafoniera a 3 luci con paralume cilindrico in polipropilene bianco perla con decoro fili. Struttura in metacrilato finitura spectrall e satinato.

3 light ceiling lamp. White pearl cylindrical polypropylene lampshade with thread texture. Methacrylate structure in spectrall and opaline white finish.

89

Attacco E27.
Lampadine: 3 x 42 W max - E27 HGS

Ø 60 cm

H 14,4 cm

E27 screw.
Bulbs: 3 x 42 W max - E27 HGS



ROSA

design by **Roberto Giacomucci**

CL 478

Plafoniera con paralume a corolla in policarbonato antiriflesso disponibile nel colore bianco.

Non-glare white polycarbonate ceiling lamp.



10

∅ 55 cm



H 23 cm

Attacco E27
Lampadine: 1 x 42 W max - E27 HGS
E27 screw
Bulbs: 1 x 42 W max - E27 HGS

CL 479

Plafoniera con paralume a corolla in policarbonato antiriflesso disponibile nel colore bianco.

Non-glare white polycarbonate ceiling lamp.



10

∅ 40 cm



H 19 cm

Attacco E27
Lampadine: 1 x 42 W max - E27 HGS
E27 screw
Bulbs: 1 x 42 W max - E27 HGS



UBI

design by **Roberto Giacomucci**

CL 389 FIORI - CL 390 FILI

Spot con cilindro in metacrilato rasterizzato. Supporto in acciaio con trattamento galvanico. Disponibile nelle versioni: cromo, oro e rame.

Spot with raster methacrylate cylinder. Steel fitting. Texture available in: chrome, gold and copper.



Attacco : GX53-1
Lampadine 1 X 9 W - GX 53 - 1 LED
Lampadine 1 X 9 W - GX 53 - 1 FB

GX53-1 screw
Bulbs 1 X 9 W - GX 53 - 1 LED
Bulbs 1 X 9 W - GX 53 - 1 FB



34 35 36

CL 387 FIORI - CL 388 FILI

Spot con cilindro in metacrilato rasterizzato. Supporto in acciaio con trattamento galvanico. Disponibile nelle versioni: cromo, oro e rame.

Spot with raster methacrylate cylinder. Steel fitting. Texture available in: chrome, gold and copper.

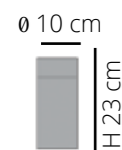

Attacco : GX53-1
Lampadine 1 X 9 W - GX 53 - 1 LED
Lampadine 1 X 9 W - GX 53 - 1 FB

GX53-1 screw
Bulbs 1 X 9 W - GX 53 - 1 LED
Bulbs 1 X 9 W - GX 53 - 1 FB

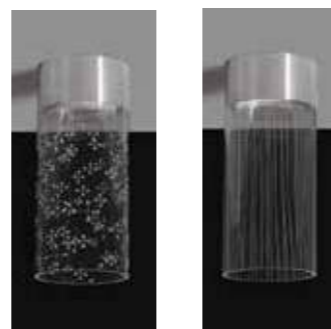

34 35 36

CL 385 FIORI - CL 386 FILI

Spot con cilindro in metacrilato rasterizzato. Supporto in acciaio con trattamento galvanico. Disponibile nelle versioni: cromo, oro e rame.

Spot with raster methacrylate cylinder. Steel fitting. Texture available in: chrome, gold and copper.

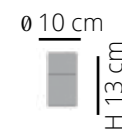

Attacco : GX53-1 Lampadine 1 X 9 W - GX 53 - 1 LED
Lampadine 1 X 7 W - GX 53 - 1 FB

GX53-1 Screw
Bulbs 1 X 9 W - GX 53 - 1 LED
Bulbs 1 X 9 W - GX 53 - 1 FB

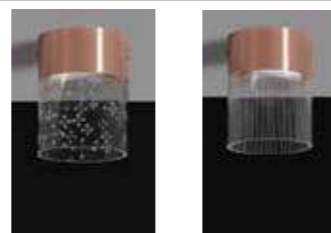

34 35 36



DAMA

design by UTE

CL 1508

Plafoniera rettangolare 8 luci in acrilico. Disponibile nei colori kristalchromo, kristaloro e kristalbronzo.

Rectangular ceiling lamp with 8 lights available in: kristalchrome, kristalgold and kristalbronze.

55 57 59

L 120 cm



P 33 cm

Attacchi GX53-1

Lampadine: 8 X 9 W max- GX53-1 FB

Lampadine: 8 X 9 W max- GX 53-1 led

Bulbs: 8 X 9 W max- GX53-1 FB

Bulbs: 8 X 9 W max- GX 53-1 led

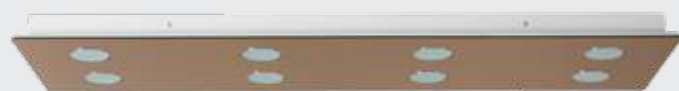
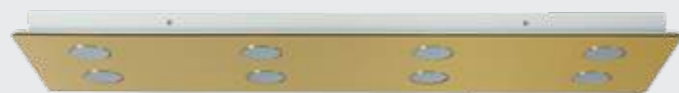
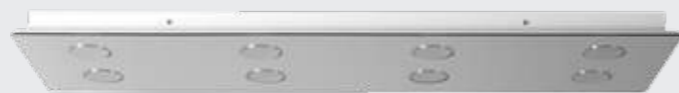

CL 1504

Plafoniera rettangolare 4 luci in acrilico. Disponibile nei colori kristalchromo, kristaloro e kristalbronzo.

Rectangular ceiling lamp with 4 lights available in: kristalchrome, kristalgold and kristalbronze.

55 57 59

L 120 cm

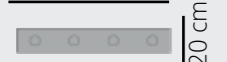

P 20 cm

Attacchi GX53-1

Lampadine: 4 X 9 W max- GX53-1 FB

Lampadine: 4 X 9 W max- GX 53-1 led

Metal ceiling fitting.

Bulbs: 4 X 9 W max- GX53-1 FB

Bulbs: 4 X 9 W max- GX 53-1 led

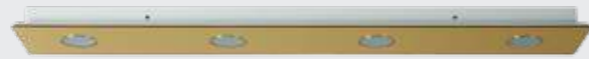

DAMA

design by UTE

CL 1503

Plafoniera rettangolare 3 luci in acrilico. Disponibile nei colori kristalcromo, kristaloro e kristalbronzo.

Rectangular ceiling lamp with 3 lights available in: kristalchrome, kristalgold and kristalbronze.

55 57 59

L 90 cm
P 20 cm

Attacchi GX53-1
Lampadine: 3 X 7 W max- GX53-1 FB
Lampadine: 3 X 9 W max- GX 53-1 led

Bulbs: 3 X 7 W max- GX53-1 FB
Bulbs: 3 X 9 W max- GX 53-1 led

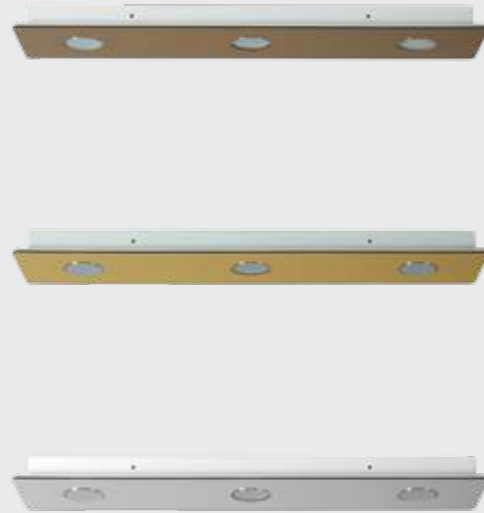

CL 1502

Plafoniera rettangolare 2 luci in acrilico. Disponibile nei colori kristalcromo, kristaloro e kristalbronzo.

Rectangular ceiling lamp with 2 lights available in: kristalchrome, kristalgold and kristalbronze.

55 57 59

L 60 cm
P 20 cm

Attacchi GX53-1
Lampadine: 2 X 7 W max- GX53-1 FB
Lampadine: 2 X 9 W max- GX 53-1 led

Bulbs: 2 X 7 W max- GX53-1 FB
Bulbs: 2 X 9 W max- GX 53-1 led

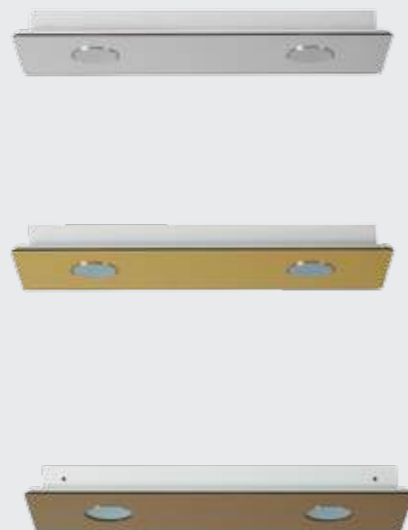

DAMA

design by UTE

CL 1507

Plafoniera quadrata 4 luci in acrilico. Disponibile nei colori kristalcromo, kristaloro e kristalbronzo.

Square ceiling lamp with 4 lights available in: kristalchrome, kristalgold and kristalbronze.

55 57 59

Attacchi GX53-1
Lampadine: 4 X 7 W max- GX53-1 FB
Lampadine: 4 X 9 W max- GX 53-1 led

Bulbs: 4 X 7 W max- GX53-1 FB
Bulbs: 4 X 9 W max- GX 53-1 led

L 40 cm
P 40 cm

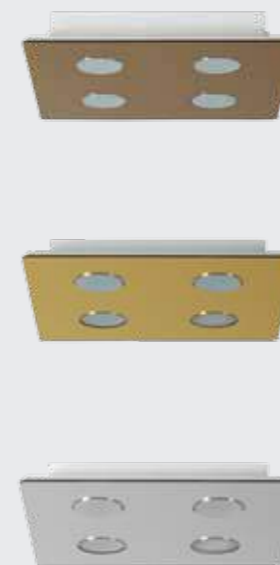

CL 1505

Plafoniera quadrata 5 luci in metacrilato bicolore bianco e trasparente.

Square ceiling lamp with 5 lights. Structure in bicolor methacrylate, white and transparent.

55 57 59

Attacchi GX53-1
Lampadine: 5 X 7 W max- GX53-1 FB
Lampadine: 5 X 9 W max- GX 53-1 led

Bulbs: 5 X 7 W max- GX53-1 FB
Bulbs: 5 X 9 W max- GX 53-1 led

L 48 cm
P 48 cm



CL 1506

Plafoniera quadrata 6 luci in acrilico. Disponibile nei colori kristalchrome, kristaloro e kristalbronzo.

Square ceiling lamp with 6 lights available in: kristalchrome, kristalgold and kristalbronze.



L 58 cm



P 58 cm

Attacchi GX 53-1.

Lampadine: 6 X 7 W max- GX53-1 FB

Lampadine: 6 X 9 W max- GX 53-1 led

Bulbs: 6 X 7 W max- GX53-1 FB

Bulbs: 6 X 9 W max- GX 53-1 led



CL 1501

Plafoniera quadrata 1 luce in acrilico. Disponibile nei colori kristalchrome, kristaloro e kristalbronzo.

Square ceiling lamp available in: kristalchrome, kristalgold and kristalbronze.

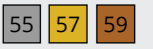

L 19 cm



P 19 cm

Attacchi GX53-1

Lampadine: 1 X 7 W max- GX53-1 FB

Lampadine: 1 X 9 W max- GX 53-1 led

Bulbs: 1 X 7 W max- GX53-1 FB

Bulbs: 1 X 9 W max- GX 53-1 led



CL 1500

Spot rotondo 1 luce in acrilico. Disponibile nei colori kristalchrome, kristaloro e kristalbronzo.

Spot available in: kristalchrome, kristalgold and kristalbronze.



Ø18 cm



Attacchi G53-1

Lampadine: 1 X 7 W max- GX53-1 FB

Lampadine: 1 X 9 W max- GX 53-1 led

Bulbs: 1 X 7 W max- GX53-1 FB

Bulbs: 1 X 9 W max- GX 53-1 led





ENJOY
the little
★
THINGS



DAMA

design by UTE

CL 1512

Sospensione rettangolare 2 luci in acrilico. Disponibile nei colori kristalchromo, kristaloro e kristalbronzo.

Rectangular suspension lamp with 2 lights available in: kristalchrome, kristalgold and kristalbronze.

55 57 59

L 60 cm
P 20 cm

Attacco : GX 53-1.
Lampadine: 2 X 7 W max- GX53-1 FB
Lampadine: 2 X 9 W max- GX 53-1 led
Bulbs: 2 X 7 W max- GX53-1 FB
Bulbs: 2 X 9 W max- GX 53-1 led

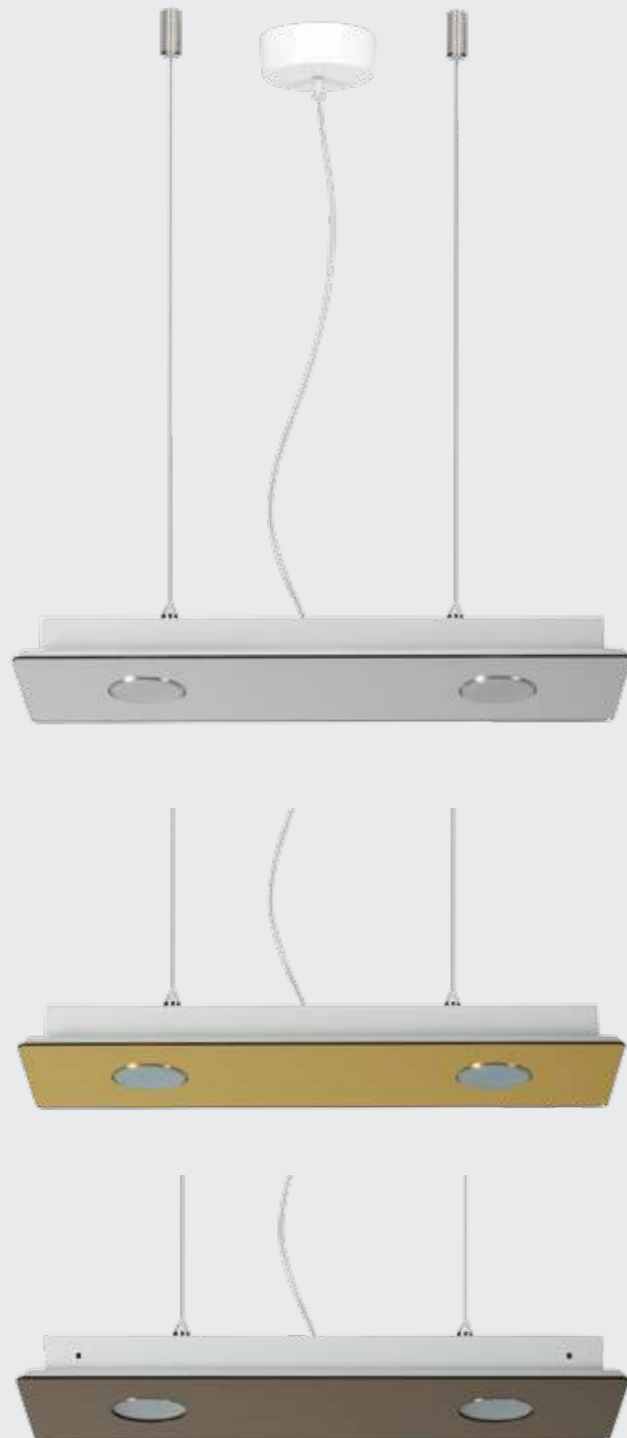

DAMA

design by UTE

CL 1513

Sospensione rettangolare 3 luci in acrilico. Disponibile nei colori kristalchromo, kristaloro e kristalbronzo.

Rectangular suspension lamp with 3 lights available in: kristalchrome, kristalgold and kristalbronze.

55 57 59

L 90 cm
P 20 cm

Attacco : GX53-1.
Lampadine: 3 X 7 W max- GX53-1 FB
Lampadine: 3 X 9 W max- GX 53-1 led
Bulbs: 3 X 7 W max- GX53-1 FB
Bulbs: 3 X 9 W max- GX 53-1 led

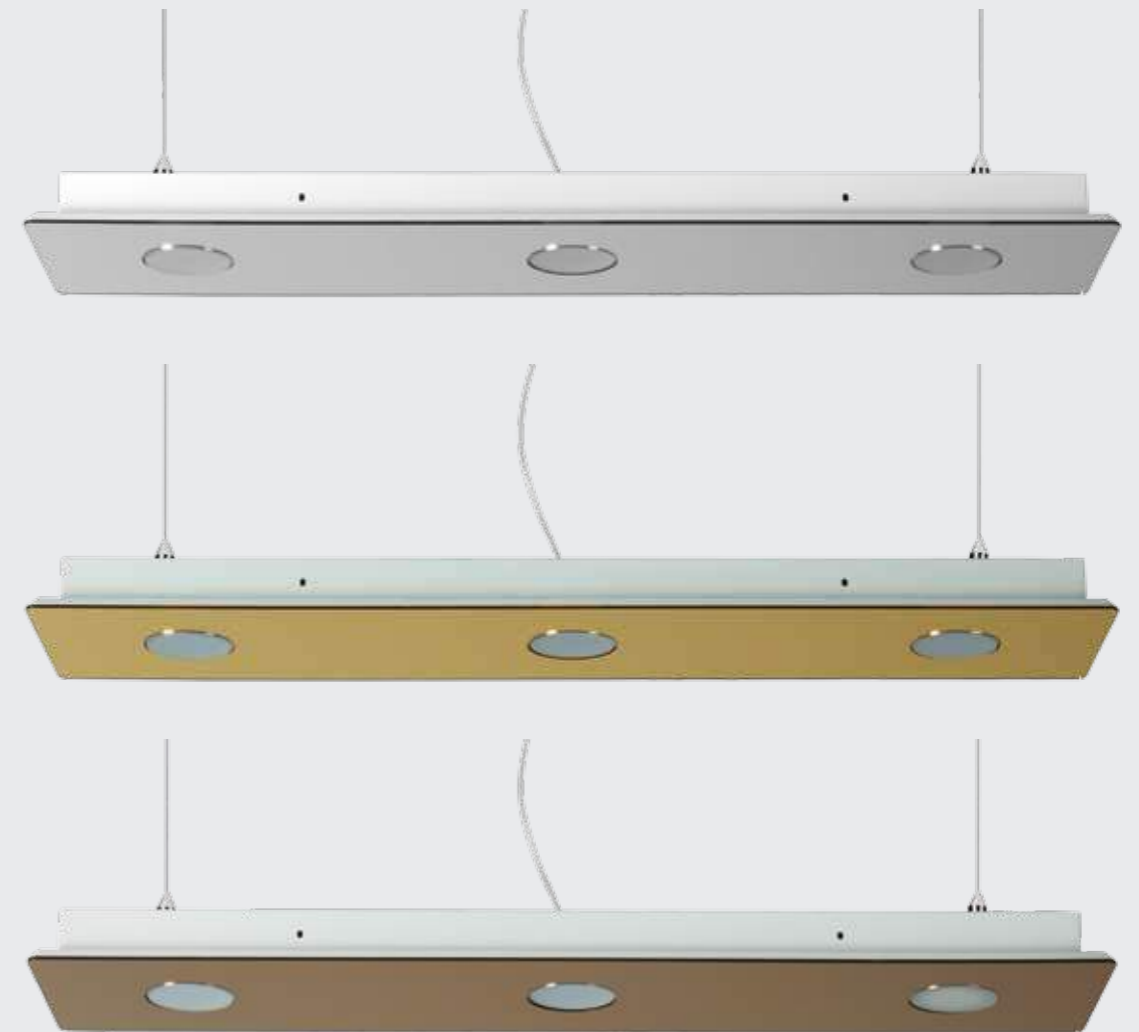

DAMA

design by UTE

CL 1514

Sospensione rettangolare 4 luci in acrilico. Disponibile nei colori kristalcromo, kristaloro e kristalbronzo.

Rectangular suspension lamp with 4 lights available in: kristalchrome, kristalgold and kristalbronze.

55 57 59



Attacco GX 53-1 .
Lampadine: 4 X 7 W max- GX53-1 FB
Lampadine: 4 X 9 W max- GX 53-1 led

Bulbs: 4 X 7 W max- GX53-1 FB
Bulbs: 4 X 9 W max- GX 53-1 led



DAMA

design by UTE

CL 1517

Sospensione rettangolare 8 luci in acrilico. Disponibile nei colori kristalcromo, kristaloro e kristalbronzo.

Rectangular suspension lamp with 8 lights available in: kristalchrome, kristalgold and kristalbronze.

55 57 59



Attacco GX 53-1 .
Lampadine: 8 X 7 W max- GX53-1 FB
Lampadine: 8 X 9 W max- GX 53-1 led

Bulbs: 8 X 7 W max- GX53-1 FB
Bulbs: 8 X 9 W max- GX 53-1 led



CL 1511

Sospensione quadrata 4 luci in acrilico. Disponibile nei colori kristalchromo, kristaloro e kristalbronzo.

Square suspension lamp with 4 lights available in: kristalchrome, kristalgold and kristalbronze.



L 40 cm



Attacco GX 53-1.

Lampadine: 4 X 7 W max- GX53-1 FB

Lampadine: 4X 9 W max- GX 53-1 led

Bulbs: 4 X 7 W max- GX53-1 FB

Bulbs: 4 X 9 W max- GX 53-1 led

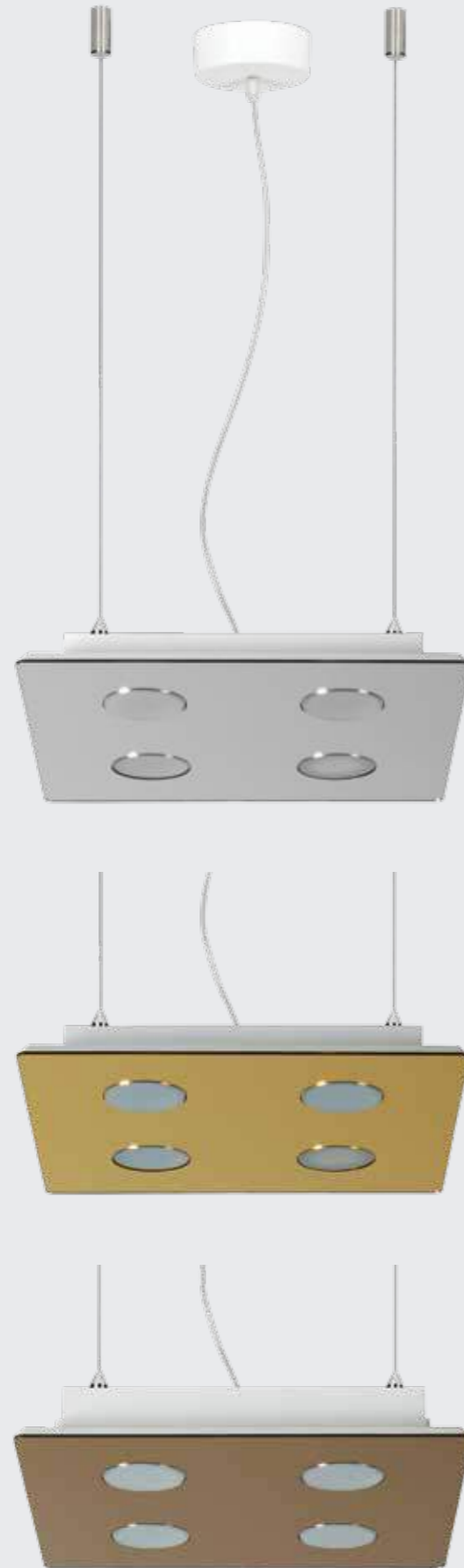

CL 1515

Sospensione quadrata 5 luci in acrilico. Disponibile nei colori kristalchromo, kristaloro e kristalbronzo.

Square suspension lamp with 5 lights available in: kristalchrome, kristalgold and kristalbronze.



L 48 cm

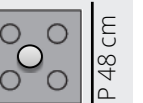

Attacco GX 53-1.

Lampadine: 5 X 7 W max- GX53-1 FB

Lampadine: 5 X 9 W max- GX 53-1 led

Bulbs: 5 X 7 W max- GX53-1 FB

Bulbs: 5 X 9 W max- GX 53-1 led

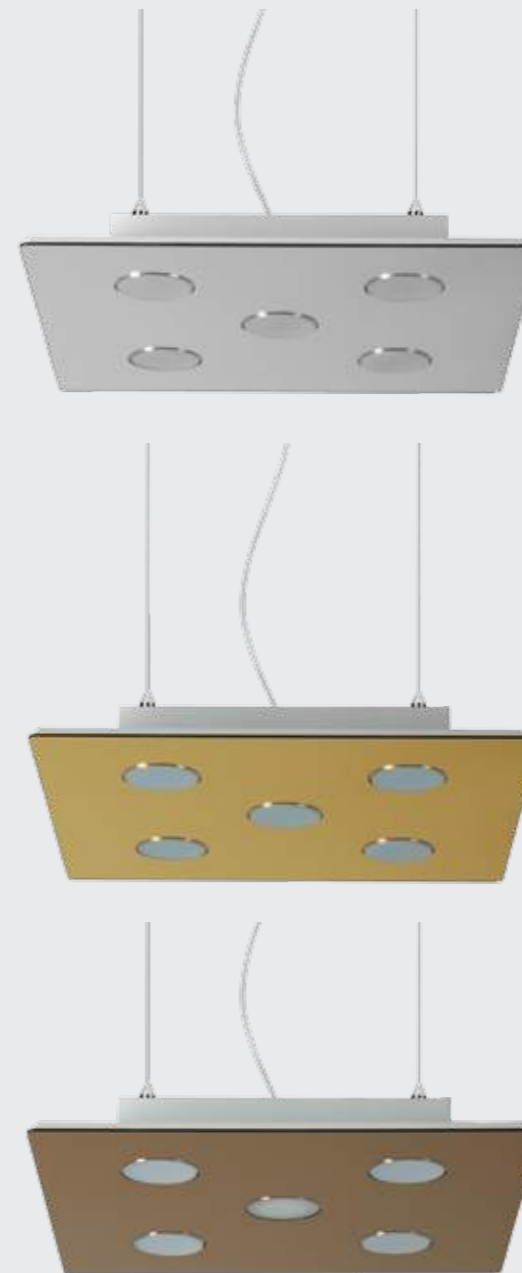

DAMA

design by UTE

CL 1516

Sospensione quadrata 6 luci in acrilico. Disponibile nei colori kristalchromo, kristaloro e kristalbronzo.

Square suspension lamp with 6 lights available in: kristalchrome, kristalgold and kristalbronze.

55 57 59

L 58 cm



P 58 cm

Attacchi GX 53-1.

Lampadine: 6 X 7 W max- GX53-1 FB

Lampadine: 6 X 9 W max- GX 53-1 led

Bulbs: 6 X 7 W max- GX53-1 FB

Bulbs: 6 X 9 W max- GX 53-1 led

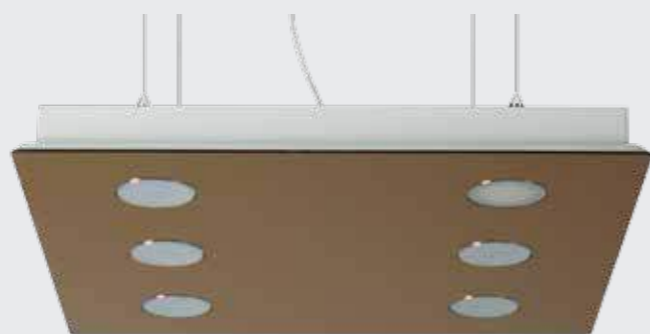
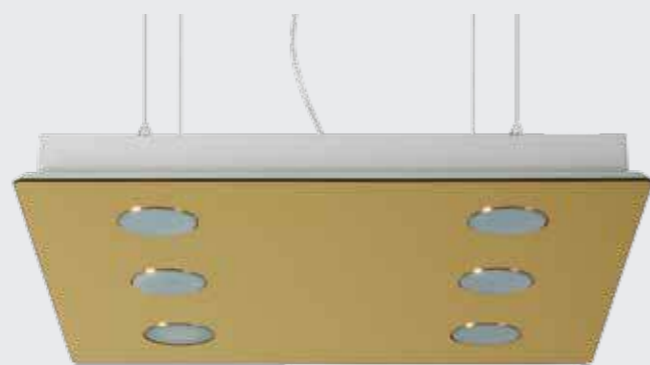

DOMINO

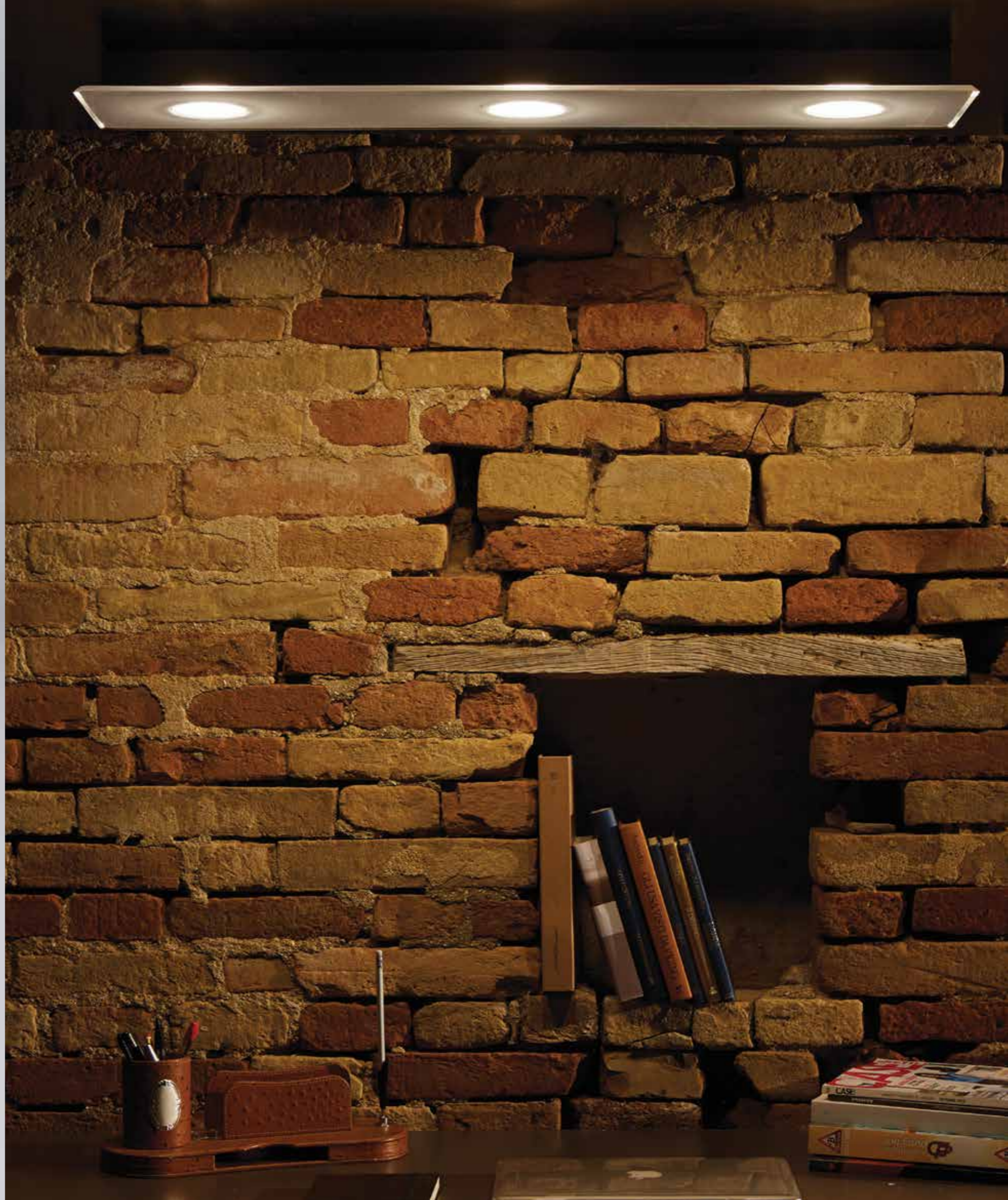

DOMINO

design by **Roberto Giacomucci**

CL 698

Plafoniera rettangolare 8 luci in metacrilato bicolore bianco e trasparente.

Square ceiling lamp with 8 lights. Structure in bicolor methacrylate, white and transparent.

10

L 120 cm
P 35 cm
Attacchi GX53-1
Lampadine: 8 X 9 W max- GX53-1 FB
Lampadine: 8 X 9 W max- GX 53-1 led
Bulbs: 8 X 9 W max- GX53-1 FB
Bulbs: 8 X 9 W max- GX 53-1 led



DOMINO

design by **Roberto Giacomucci**

CL 585

Plafoniera rettangolare 3 luci in metacrilato bicolore bianco e trasparente.

Rectangular ceiling lamp with 3 lights. Structure in bicolor methacrylate, white and transparent.

10

L 90 cm
P 20 cm
Attacchi GX53-1
Lampadine: 3 X 9 W max- GX53-1 FB
Lampadine: 3 X 9 W max- GX 53-1 led
Bulbs: 3 X 9 W max- GX53-1 FB
Bulbs: 3 X 9 W max- GX 53-1 led



CL 586

Plafoniera rettangolare 4 luci in metacrilato bicolore bianco e trasparente.

Rectangular ceiling lamp with 4 lights. Structure in bicolor methacrylate, white and transparent.

10

L 120 cm
P 20 cm
Attacchi GX53-1
Lampadine: 4 X 9 W max- GX53-1 FB
Lampadine: 4 X 9 W max- GX 53-1 led
Bulbs: 4 X 9 W max- GX53-1 FB
Bulbs: 4 X 9 W max- GX 53-1 led



CL 584

Plafoniera rettangolare 2 luci in metacrilato bicolore bianco e trasparente.

Rectangular ceiling lamp with 2 lights. Structure in bicolor methacrylate, white and transparent.

10

L 60 cm
P 20 cm
Attacchi GX53-1
Lampadine: 2 X 9 W max- GX53-1 FB
Lampadine: 2 X 9 W max- GX 53-1 led
Bulbs: 2 X 9 W max- GX53-1 FB
Bulbs: 2 X 9 W max- GX 53-1 led



DOMINO

design by **Roberto Giacomucci**

CL 696

Plafoniera quadrata 6 luci in metacrilato bicolore bianco e trasparente.

Square ceiling lamp with 6 lights.
Structure in bicolor methacrylate, white and transparent.

10



L 58 cm
P 58 cm
Attacchi GX53-1
Lampadine: 6 X 9 W max- GX53-1 FB
Lampadine: 6 X 9 W max- GX 53-1 led
Bulbs: 6 X 9 W max- GX53-1 FB
Bulbs: 6 X 9 W max- GX 53-1 led

DOMINO

design by **Roberto Giacomucci**

CL 582

Plafoniera quadrata 4 luci in metacrilato bicolore bianco e trasparente.

Square ceiling lamp with 4 lights. Structure in bicolor methacrylate, white and transparent.

10



L 40 cm
P 40 cm
Attacchi GX53-1
Lampadine: 4 X 9 W max- GX53-1 FB
Lampadine: 4 X 9 W max- GX 53-1 led
Bulbs: 4 X 9 W max- GX53-1 FB
Bulbs: 4 X 9 W max- GX 53-1 led

CL 699

Plafoniera quadrata 5 luci in metacrilato bicolore bianco e trasparente.

Square ceiling lamp with 5 lights.
Structure in bicolor methacrylate, white and transparent.

10



L 48 cm
P 48 cm
Attacchi GX53-1
Lampadine: 5 X 9 W max- GX53-1 FB
Lampadine: 5 X 9 W max- GX 53-1 led
Bulbs: 5 X 9 W max- GX53-1 FB
Bulbs: 5 X 9 W max- GX 53-1 led

CL 583

Plafoniera quadrata 1 luce in metacrilato bicolore bianco e trasparente.

Square ceiling lamp. Structure in bicolor methacrylate, white and transparent.

10



L 20 cm
P 20 cm
Attacchi GX53-1
Lampadine: 1 X 9 W max- GX53-1 FB
Lampadine: 1 X 9 W max- GX 53-1 led
Bulbs: 1 X 9 W max- GX53-1 FB
Bulbs: 1 X 9 W max- GX 53-1 led

CL 576

Spot in metacrilato bicolore bianco e trasparente.
Spot. Structure in bicolor methacrylate, white and transparent.

10



Ø 18 cm
Attacchi G53-1
Lampadine: 1 X 9 W max- GX53-1 FB
Lampadine: 1 X 9 W max- GX 53-1 led
Bulbs: 1 X 9 W max- GX53-1 FB
Bulbs: 1 X 9 W max- GX 53-1 led

DOMINO

design by **Roberto Giacomucci**

CL 695

Sospensione quadrata 6 luci in metacrilato bicolore bianco e trasparente.

Square suspension lamp with 6 lights. Structure in bicolor methacrylate, white and transparent.

10

L 58 cm

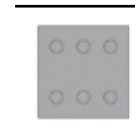

P 58 cm

Attacchi GX 53-1.

Lampadine: 6 X 7 W max- GX53-1 FB
Lampadine: 6 X 9 W max- GX 53-1 led

Bulbs: 6 X 7 W max- GX53-1 FB
Bulbs: 6 X 9 W max- GX 53-1 led



CL 599

Sospensione quadrata 5 luci in metacrilato bicolore bianco e trasparente.

Square suspension lamp with 5 lights. Structure in bicolor methacrylate, white and transparent.

10

L 48 cm

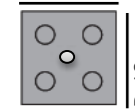

P 48 cm

Attacchi GX53-1 Filo.

Lampadine: 5X 9 W max- GX53-1 FB
Lampadine: 5 X 9 W max- GX 53-1 led

Bulbs: 5 X 9 W max- GX53-1 FB
Bulbs: 5 X 9 W max- GX 53-1 led



CL 581

Sospensione quadrata 4 luci in metacrilato bicolore bianco e trasparente.

Square suspension lamp with 4 lights. Structure in bicolor methacrylate, white and transparent.

10

L 40 cm

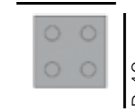

P 40 cm

Attacco GX 53-1.

Lampadine: 4 X 7 W max- GX53-1 FB
Lampadine: 4X 9 W max- GX 53-1 led

Bulbs: 4 X 7 W max- GX53-1 FB
Bulbs: 4 X 9 W max- GX 53-1 led



DOMINO

design by **Roberto Giacomucci**

CL 697

Sospensione rettangolare 8 luci in metacrilato bicolore bianco e trasparente.

Rectangular suspension lamp with 8 lights. Structure in bicolor methacrylate, white and transparent.

10



L 120 cm
P 35 cm

Attacchi GX53-1
Lampadine: 8 X 9 W max- GX53FB
Lampadine: 8 X 9 W max- GX 53

Bulbs: 8 X 9 W max- GX53FB
Bulbs: 8 X 9 W max- GX 53

CL 580

Sospensione rettangolare 4 luci in metacrilato bicolore bianco e trasparente.

Rectangular suspension lamp with 4 lights. Structure in bicolor methacrylate, white and transparent.

10



L 120 cm
P 20 cm

Attacco GX 53-1
Lampadine: 4 X 7 W max- GX53-1 FB
Lampadine: 4 X 9 W max- GX 53-1 led

Bulbs: 4 X 7 W max- GX53-1 FB
Bulbs: 4 X 9 W max- GX 53-1 led

CL 579

Sospensione rettangolare 3 luci in metacrilato bicolore bianco e trasparente.

Rectangular suspension lamp with 3 lights. Structure in bicolor methacrylate, white and transparent.

10



L 90 cm
P 20 cm

Attacco: GX53-1.
Lampadine: 3 X 7 W max- GX53-1 FB
Lampadine: 3 X 9 W max- GX 53-1 led

Bulbs: 3 X 7 W max- GX53-1 FB
Bulbs: 3 X 9 W max- GX 53-1 led

CL 578

Sospensione rettangolare 2 luci in metacrilato bicolore bianco e trasparente.

Rectangular suspension lamp with 2 lights. Structure in bicolor methacrylate, white and transparent.

10



L 60 cm
P 20 cm

Attacco : GX 53-1.
Lampadine: 2 X 7 W max- GX53-1 FB
Lampadine: 2 X 9 W max- GX 53-1 led

Bulbs: 2 X 7 W max- GX53-1 FB
Bulbs: 2 X 9 W max- GX 53-1 led



ALLEGRETTA

design by Romeo Guaricci

CL 1400

Sospensione in metacrilato disponibile nei colori: satinato, spectrall e fumé.

Methacrylate suspension lamp available in: opaline white, spectrall and smoked grey.

12 88 98



Attacco E27. Filo L. 160 cm.
Lampadine: 1 x 70 W max - E27 HGS

E27 screw. Wire length 160 cm.
Bulbs: 1 x 70 W max - E27 HGS



CL 1401

Sospensione in metacrilato disponibile nel colore: texturgold.

Methacrylate suspension lamp available in: texturgold.

58



ALLEGRETTA

design by Romeo Guaricci

∅ 22 cm



Attacco E14. Filo L.160 cm.
Lampadine: 1 x 15 W max - E14 FBT

E14 screw. Wire length 160 cm.
Bulbs: 1 x 15 W max - E14 FBT

CL 1402 12 88 98

Sospensione in metacrilato disponibile nei colori:
satinato, spectrall e fumé.

Methacrylate suspension lamp available in:
opaline white, spectrall and smoked grey.

CL 1403 58

Sospensione in metacrilato disponibile nel colore: texturgold.
Methacrylate suspension lamp available in: texturgold.

∅ 22 cm



Attacco E14. Filo L.160 cm.
Lampadine: 2 x 15 W max - E14 FBT

E14 screw. Wire length 160 cm.
Bulbs: 2 x 15 W max - E14 FBT

12 88 98 CL 1404

Sospensione in metacrilato disponibile nei colori:
satinato, spectrall e fumé.

Methacrylate suspension lamp available in:
opaline white, spectrall and smoked grey.

58 CL 1405

Sospensione in metacrilato disponibile nel colore: texturgold.
Methacrylate suspension lamp available in: texturgold.

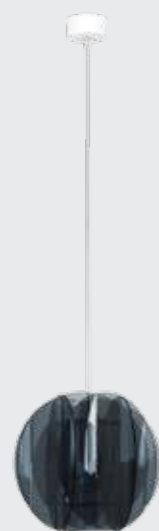

AMARILLI

design by Roberto Giacomucci

CL 481

Sospensione in metacrilato disponibile nei colori: trasparente, satinato, rosso, spectrall e fumé.

Methacrylate suspension lamp available in: transparent, opaline white, red, spectrall and smoked.

11 12 51 88 98

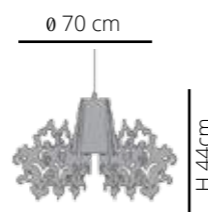

Attacco E27. Filo L. 160 cm.
Lampadine: 1 x 70 W max - E27 HGS

E27 screw. Wire length 160 cm.
Bulbs: 1 x 70 W max - E27 HGS

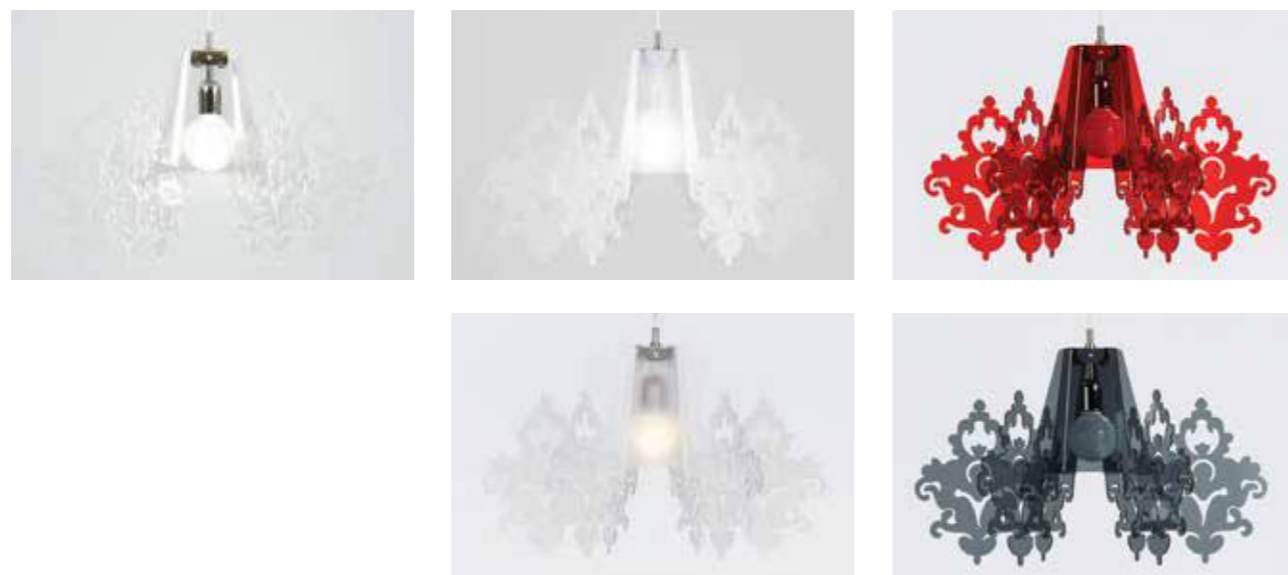

CL 482

Sospensione in metacrilato disponibile nel colore: texturgold.

Methacrylate suspension lamp available in: texturgold.

58



CL 607

Sospensione in metacrilato disponibile nel colore: cromolite.

Methacrylate suspension lamp available in: cromolite.

55



COTTON LIGHT

design by Mammini Candido

CL 1462

Sospensione 3 luci in sandylex bianco pearl.

3 light suspension lamp in pearl white sandylex.

15

Ø 63



Lampadine: 3x53W max - E27 HGS

Bulbs: 3x53W max - E27 HGS



CL 1463

Sospensione 3 luci in sandylex bianco pearl con decori viola o grigio.

3 light suspension lamp in purple or grey sandylex.

29

91



COTTON LIGHT

design by Mammini Candido

CL 1464

Sospensione in sandylex bianco pearl.
Suspension lamp in pearl white sandylex.

15

Ø 46

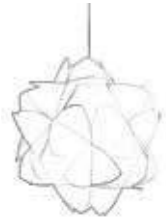

Lampadine: 1/2x70W max - E27 HGS
Bulbs: 1/2x70W max - E27 HGS



CL 1465

Sospensione in sandylex bianco pearl con decori viola o grigio.
Suspension lamp in purple or grey sandylex.

29 91



CARIOCA

design by Roberto Giacomucci

CL 325

Sospensione in metacrilato disponibile nei colori verde, giallo, arancio, rosa, rosso, blu e multicolor.

Methacrylate suspension lamp available in: green, yellow, orange, pink, red, blue and multicolor.

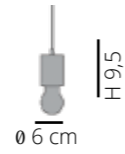

Attacchi E27.
Lampadine: 1 x 70 W max - E27 HGS

E27 screw.
Bulbs: 1 x 70 W max - E27 HGS



CIGNO

design by **Romeo Guaricci**

CL 1410

Sospensione in metacrilato disponibile nei colori:
satinato, spectrall, fumé e texture gold.

Methacrylate suspension lamp available in:
opaline white, spectrall, smoked grey and texture gold.

12 88 98

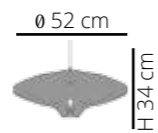

Attacco E27.
Lampadine: 1 x 42 W max - E27 HGS

E27 screw.
Bulbs: 1 x 42 W max - E27 HGS



CL 1411

Sospensione in metacrilato disponibile nei colori:
satinato, spectrall, fumé e texture gold.

Methacrylate suspension lamp available in:
opaline white, spectrall, smoked grey and texture gold.

58



CIGNO XXL

design by **Romeo Guaricci**

CL1424

Sospensione 2 luci in metacrilato disponibile nei colori: satinato, spectrall, fumé e texture gold.

2 light methacrylate suspension lamp available in: opaline white, spectrall, smoked grey and texture gold.

12 88 98

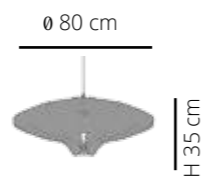

Attacco E27.
Lampadine: 2 x 53 W max - E27 HGS

E27 screw.
Bulbs: 2 x 53 W max - E27 HGS



CL 1425

Sospensione 2 luci in metacrilato disponibile nei colori: satinato, spectrall, fumé e texture gold.

2 light methacrylate suspension lamp available in: opaline white, spectrall, smoked grey and texture gold.

58

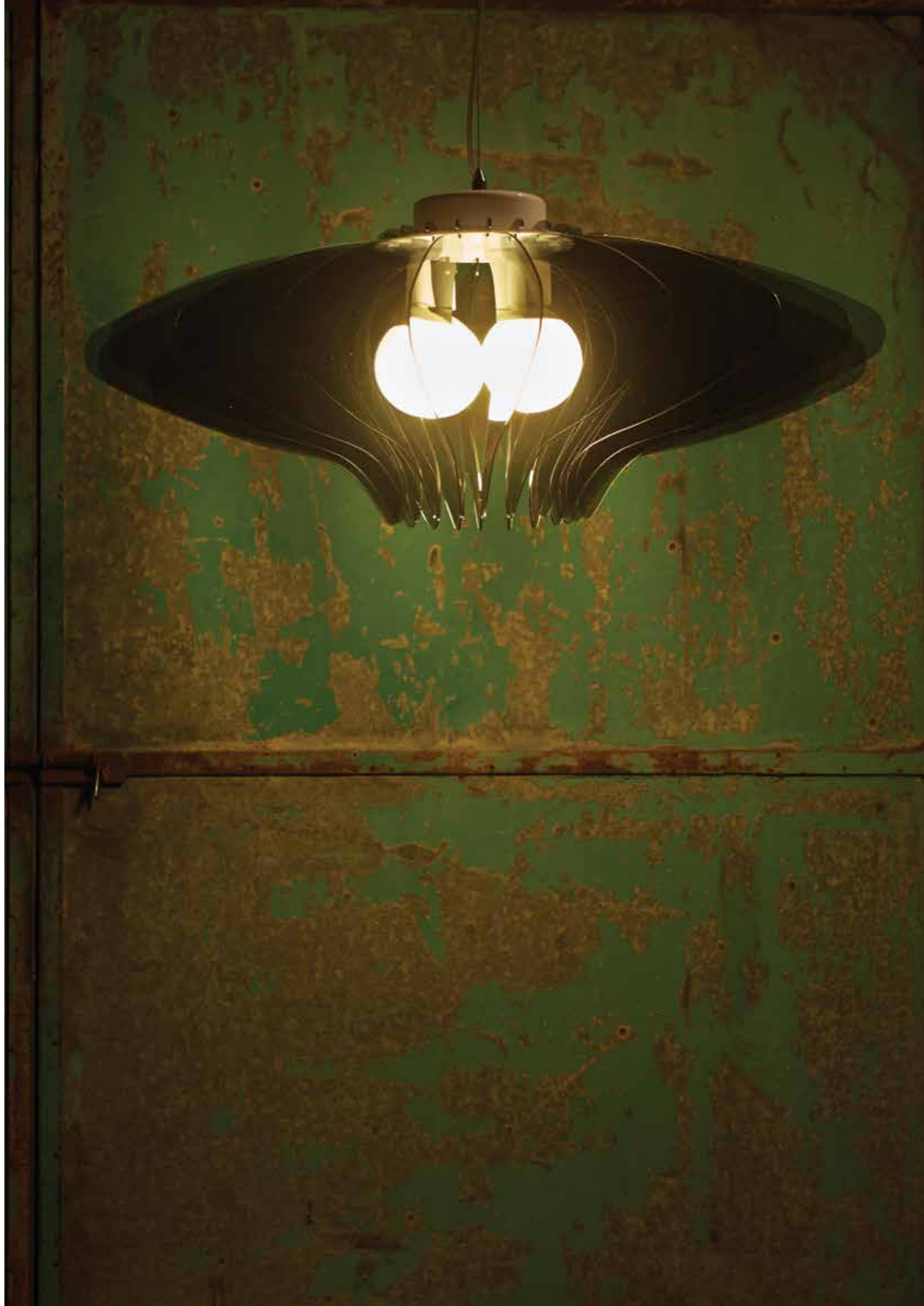

COSCIENZA

design by **Walter Sbicca**

CL 1498

Sospensione con soggetto in resina laccato oro.
(possibili altri colori del soggetto su richiesta)

Suspension lamp. Gold lacquered character.
(character available in other colours upon request)

57

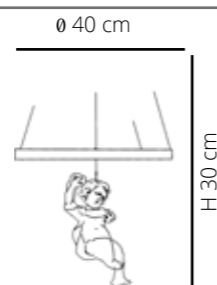

Alimentata a strip led - IP 20 - 24 V - TOT.10 W - 2650 Lumen.
Luce calda 3000K +5%

Strip led - IP 20 - 24 V - TOT.10 W - 2650 Lumen. Warm light 3000K +5%

CL 1499

Sospensione con soggetto in resina laccato rosso.
(possibili altri colori del soggetto su richiesta)

Suspension lamp. Red lacquered character.
(character available in other colours upon request)

51

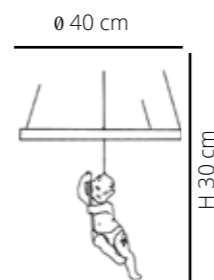

Alimentata a strip led - IP 20 - 24 V - TOT.10 W - 2650 Lumen.
Luce calda 3000K +5%

Strip led - IP 20 - 24 V - TOT.10 W - 2650 Lumen. Warm light 3000K +5%



ARALIA

design by Roberto Giacomucci



ARALIA

design by **Roberto Giacomucci**

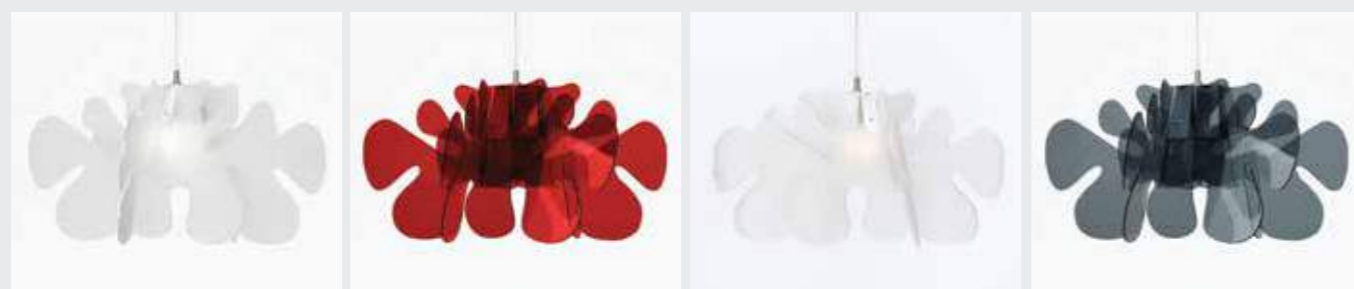

12 51 98 88

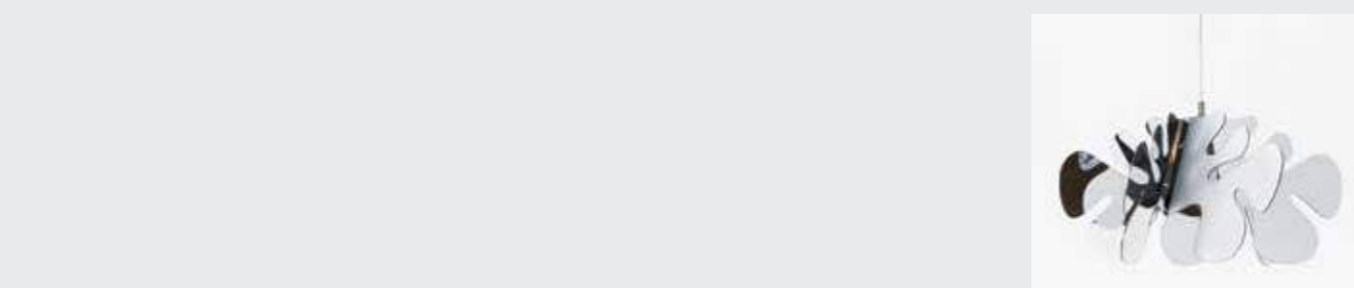

55

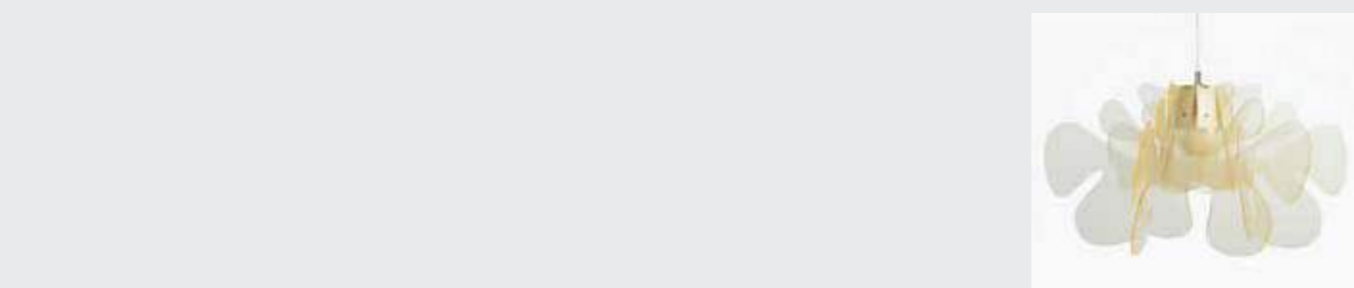

58



53 91

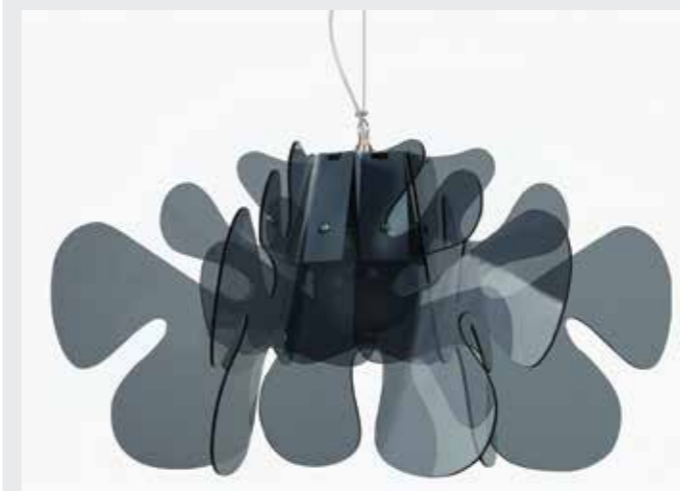

Ø 73 cm



H 40 cm

Attacco E27. Filo L. 160 cm.
Lampadine: 1 x 70 W max - E27 HGS

E27 screw. Wire length 160 cm.
Bulbs: 1 x 70 W max - E27 HGS



Sospensione in metacrilato disponibile nei colori:
Methacrylate suspension lamp available in:

CL 572 satinato, rosso, spectrall e fumé.
opaline white, red, spectral and, smoked grey. 12 51 88 98

CL 612 cromolite 55

CL 573 texturgold 58

CL 863 decoro nuance nei colori: rosso e grigio.
Natural opal version available in: red or grey. 53 91



Ø 55 cm



H 32 cm

Attacco E27. Filo L. 160 cm.
Lampadine: 1 x 70 W max - E27 HGS

E27 screw. Wire length 160 cm.
Bulbs: 1 x 70 W max - E27 HGS



Sospensione in metacrilato disponibile nei colori:
Methacrylate suspension lamp available in:

CL 570 satinato, rosso, spectrall e fumé.
opaline white, red, spectral and, smoked grey. 12 51 88 98

CL 611 cromolite 55

CL 571 texturgold 58

CL 862 decoro nuance nei colori: rosso e grigio.
Natural opal version available in: red or grey. 53 91

BEA MAXI

design by Roberto Giacomucci



BEA

design by Roberto Giacomucci

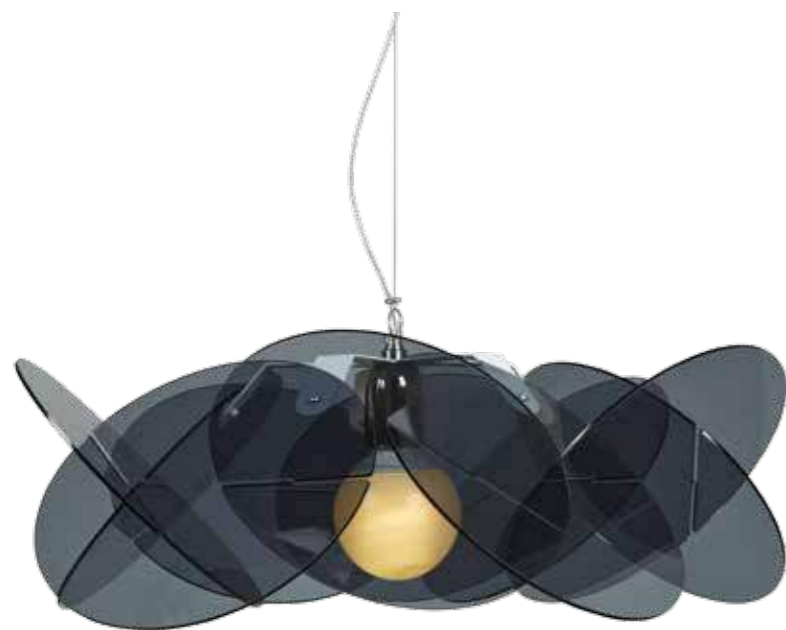



55



58



53 91

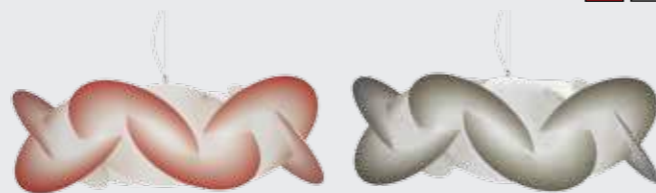

design by **Roberto Giacomucci**

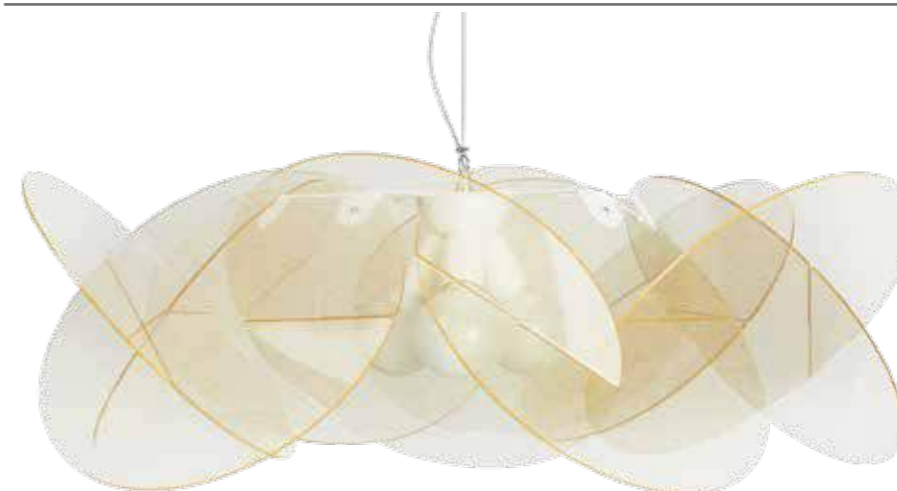

Ø 90 cm



Attacco E27.
Filo L. 160 cm.
Lampadine: 3 x 53 W max - E27 HGS

E27 screw.
Wire length 160 cm.
Bulbs: 3 x 53 W max - E27 HGS

Sospensione 3 luci in metacrilato disponibile nei colori:
3 light methacrylate suspension lamp available in:

CL 526 satinato, rosso, fumé e spectrall .
opaline white, red, smoked grey and spectral. 12 51 98 88

CL 617 cromolite 55

CL 527 texturgold 58

CL 875 decoro nuance nei colori: rosso e grigio.
Natural opal version available in: red or grey. 53 91

design by **Roberto Giacomucci**



Ø 54 cm



Attacco E27.
Filo L. 160 cm.
Lampadina: 1 x 53 W max - E27 HGS

E27 screw.
Wire length 160 cm.
Bulb: 1 x 53 W max - E27 HGS

Sospensione in metacrilato disponibile nei colori:
Methacrylate suspension lamp available in:

CL 178 satinato, rosso, fumé e spectrall .
opaline white, red, smoked grey and spectral. 12 51 98 88

CL 616 cromolite 55

CL 179 textur gold 58

CL 874 decoro nuance nei colori: rosso e grigio.
Natural opal version available in: red or grey. 53 91

BELLATRIX MAXI

design by Roberto Giacomucci



BELLATRIX

design by Roberto Giacomucci



BELLATRIX



12 51 98 88

55



58



BELLATRIX MAXI

design by **Roberto Giacomucci**

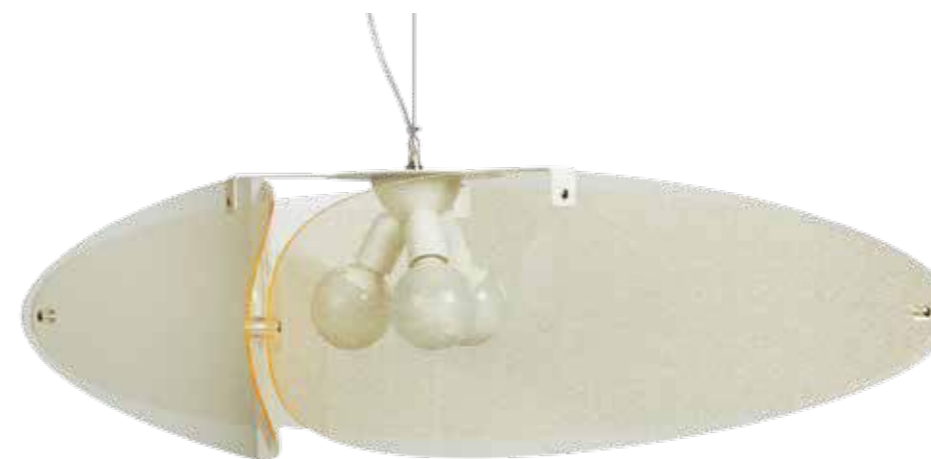

Ø 116 cm



H 33 cm



Attacco E27.
Filo L.160 cm.
Lampadine: 3 x 53 W max - E27 HGS

E27 screw.
Wire length 160 cm.
Bulbs: 3 x 53 W max - E27 HGS

Sospensione a 3 luci in metacrilato disponibile nei colori:
3 light methacrylate suspension lamp available in:

CL 524 satinato, rosso, fumé e spectrall.
opaline white, red, smoked grey and spectrall. 12 51 98 88

CL 620 cromolite 55

CL 525 texturgold 58

BELLATRIX

design by **Roberto Giacomucci**



Ø 90 cm



H 26 cm



Attacco E27.
Filo L.160 cm.
Lampadine: 1 x 70 W max - E27 HGS

E27 screw.
Wire length 160 cm.
Bulbs: 1 x 70 W max - E27 HGS

Sospensione in metacrilato disponibile nei colori:
Methacrylate suspension lamp available in:

CL 451 satinato, rosso, fumé e spectrall.
opaline white, red, smoked grey and spectrall. 12 51 98 88

CL 619 cromolite 55

CL 416 texturgold 58

BIBANG

design by Roberto Giacomucci



BIBANG MAXI

design by Roberto Giacomucci



BIBANG

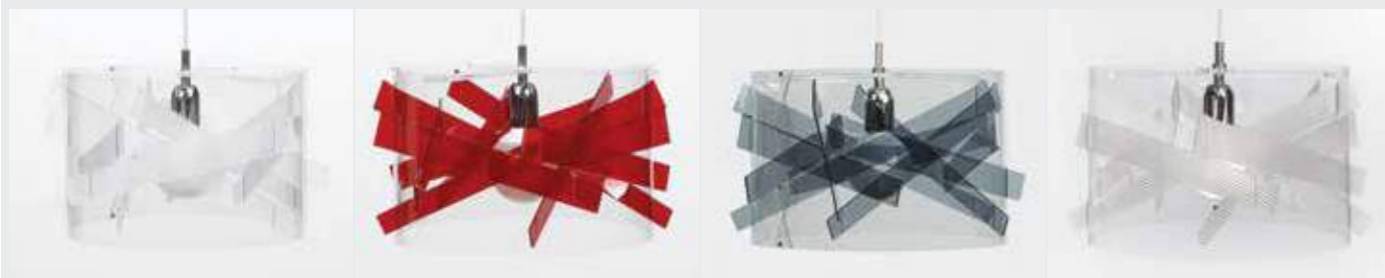

12 51 98 88

55



58



BIBANG

design by **Roberto Giacomucci**



∅ 40 cm



Attacco E27. Filo L.160 cm.
Lampadine: 1 x 70 W max - E27 HGS

E27 screw. Wire length 160 cm.
Bulbs: 1 x 70 W max - E27 HGS

Sospensione con paralume cilindrico in policarbonato trasparente ed elementi ad incastro in metacrilato nei colori:

Transparent polycarbonate suspension lamp with cylindrical lampshade. Interlocking elements available in:

CL 418 satinato, rosso, fumé e spectrall.
opaline white, red, smoked grey and spectrall.

12 51 98 88

CL 621 cromolite

55

CL 417 texturgold

58

BIBANG MAXI

design by **Roberto Giacomucci**



∅ 75 cm

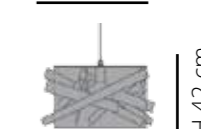

Attacco E27. Filo L.160 cm.
Lampadine: 3 x 53 W max - E27 HGS

E27 screw. Wire length 160 cm.
Bulbs: 3 x 53 W max - E27 HGS

Sospensione 3 luci con paralume cilindrico in policarbonato trasparente ed elementi ad incastro in metacrilato nei colori:

3 light transparent polycarbonate suspension lamp with cylindrical lampshade. Interlocking elements available in:

CL 528 satinato, rosso, fumé e spectrall.
opaline white, red, smoked grey and spectrall.

12 51 98 88

CL 622 cromolite

55

CL 529 texturgold

58

GALLES SMALL

design by Roberto Giacomucci



GALLES LARGE

design by Roberto Giacomucci



GALLES SMALL

design by **Roberto Giacomucci**

CL 1447

Sospensione in metacrilato sp. 20 mm.
Disponibile nei colori: trasparente, satinato e fumè.

Methacrylate suspension lamp thickness 20 mm.
Available in: transparent, opaline white and smoked grey.

11 12 91

Ø 90

Strip Led IP20 - 12V tot. 75W - Luce naturale 4000 K +5%, 15 IM/LED
Strip Led IP20 - 12V tot. 75W - light 4000 K+ 5%, 15 IM/ LED

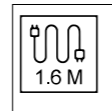

GALLES LARGE

design by **Roberto Giacomucci**

CL 1446

Sospensione a 6 luci in metacrilato sp. 20 mm.
Disponibile nei colori: trasparente, satinato e fumè.

6 light methacrylate suspension lamp thickness 20 mm.
Available in: transparent, opaline white and smoked grey.

11 12 91

Ø 127

Lampadine: 6x15W risparmio energetico. E27 FBT 6x11W LED
Bulbs: 6x15W energy saving. FBT E27 6x11W LED

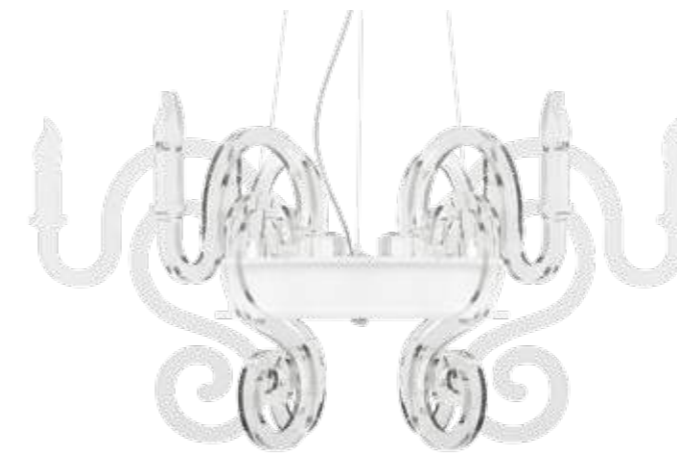

KARTIKA

design by Roberto Giacomucci

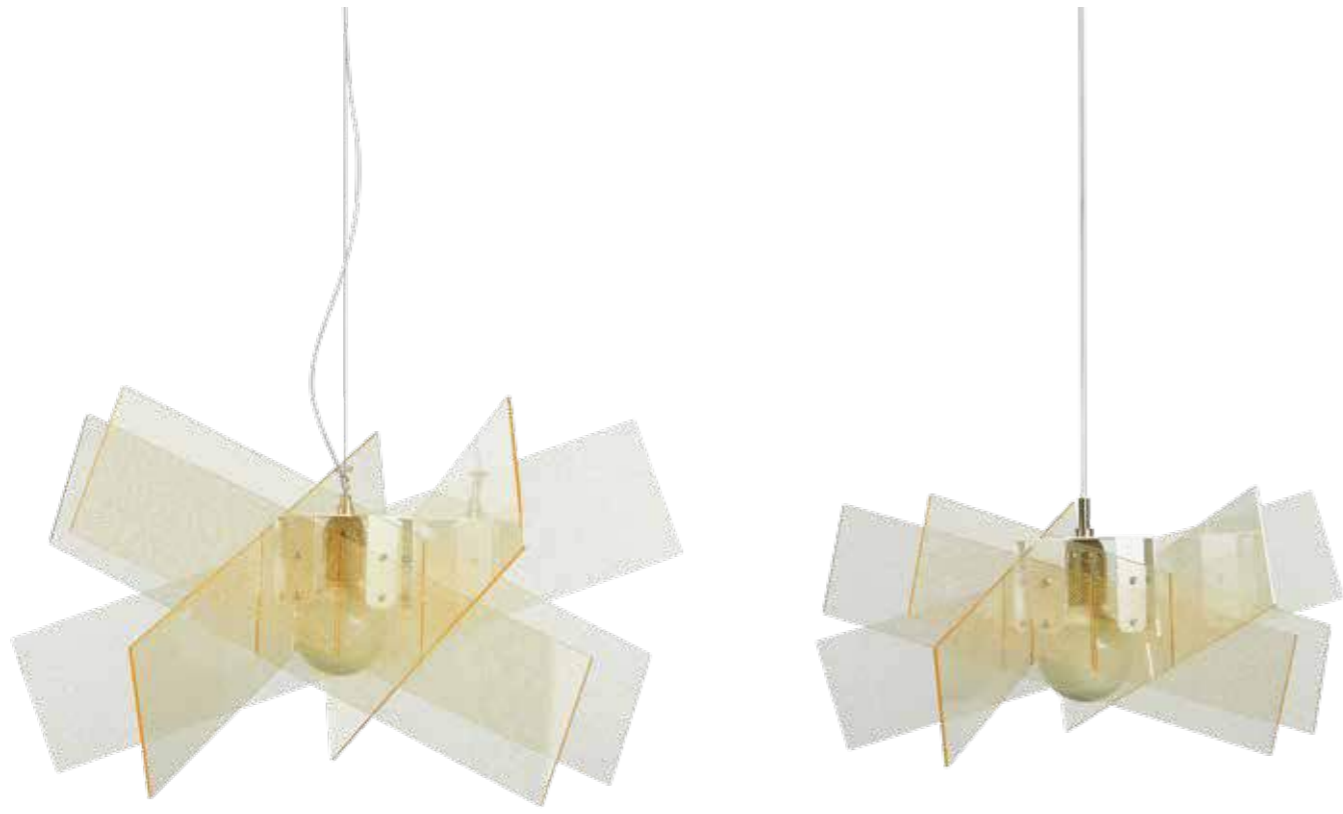

KARTIKA

12 51 98 88

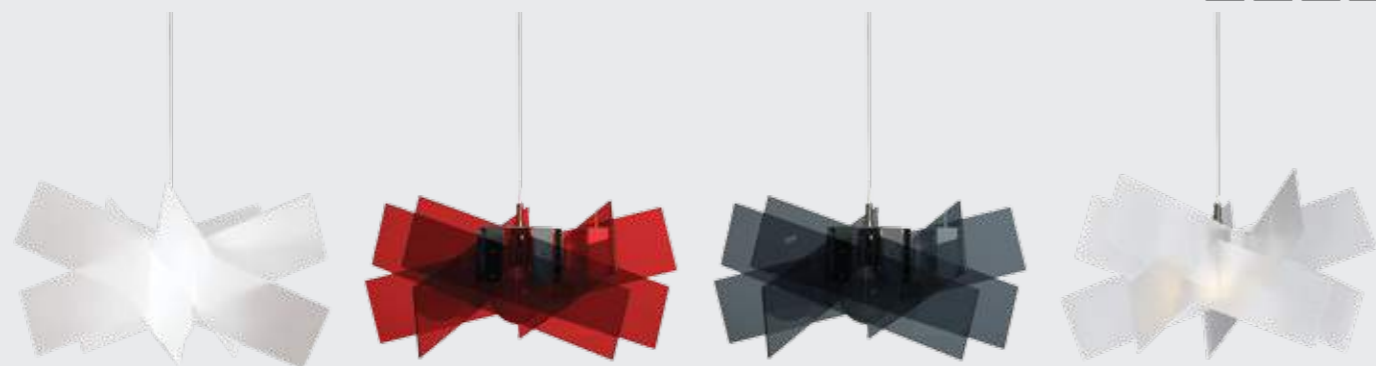

55



58



53 91

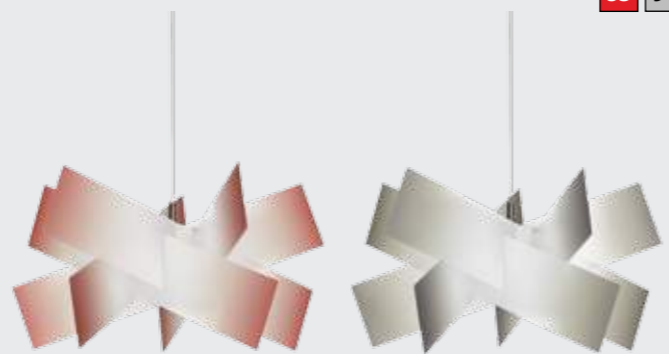

KARTIKA

design by Roberto Giacomucci

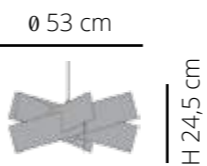

Attacco E27. Filo L.160 cm.
Lampadine: 1 x 70 W max - E27 HGS

E27 screw. Wire length 160 cm.
Bulbs: 1 x 70 W max - E27 HGS

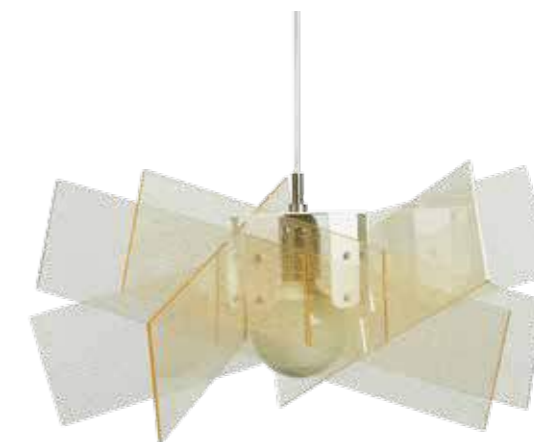

Sospensione in metacrilato disponibile nei colori:
Methacrylate suspension lamp available in:

- CL 137 satinato, rosso, fumé and spectrall. opaline white, red, smoked grey and spectrall. 12 51 98 88
- CL 636 cromolite. 55
- CL 138 texturgold. 58
- CL 865 decoro nuance nei colori: rosso e grigio. natural opal version available in: red or grey. 53 91

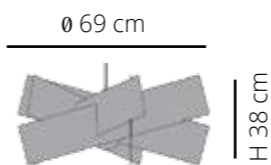

Attacco E27. Filo L.160 cm.
Lampadine: 1 x 70 W max - E27 HGS

E27 screw. Wire length 160 cm.
Bulbs: 1 x 70 W max - E27 HGS

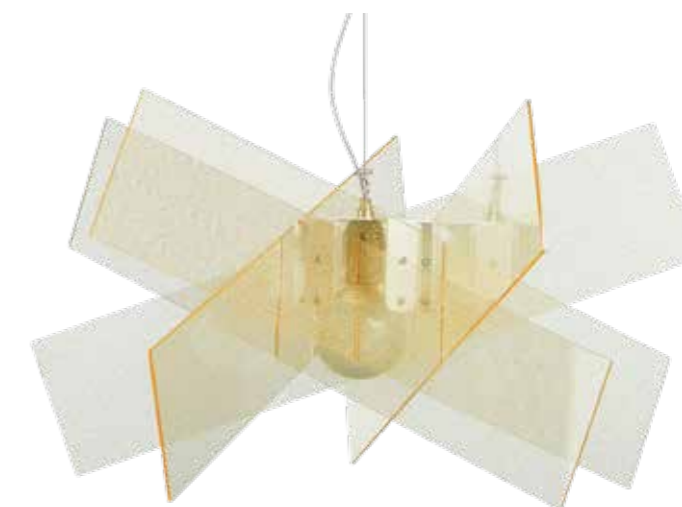

Sospensione in metacrilato disponibile nei colori:
Methacrylate suspension lamp available in:

- CL 139 satinato, rosso, fumé and spectrall. opaline white, red, smoked grey and spectrall. 12 51 98 88
- CL 637 cromolite. 55
- CL 140 texturgold. 58
- CL 866 decoro nuance nei colori: rosso e grigio. natural opal version available in: red or grey. 53 91

NUCLEA

design by Roberto Giacomucci





Sospensione a 3 luci in metacrilato disponibile nei colori:

3 light methacrylate suspension lamp available in:

- CL 129 satinato, rosso, fumé e spectrall. opaline white, red, smoked grey and spectrall. 12 51
98 88
- CL 643 cromolite 55
- CL 132 texturgold 58
- CL 869 decoro nuance nei colori: rosso e grigio. natural opal version available in: red or grey. 53 91



Attacco E27. Filo L.160 cm.
Lampadine: 3 x 53 W max - E27 HGS

E27 screw. Wire length 160 cm.
Bulbs: 3 x 53 W max - E27 HGS



Sospensione in metacrilato disponibile nei colori:

Methacrylate suspension lamp available in:

- CL 128 satinato, rosso, fumé e spectrall. opaline white, red, smoked grey and spectrall. 12 51
98 88
- CL 642 cromolite 55
- CL 131 texturgold 58
- CL 868 decoro nuance nei colori: rosso e grigio. natural opal version available in: red or grey. 53 91

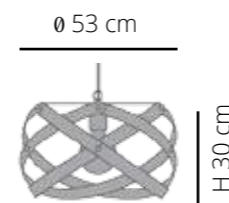

Attacco E27. Filo L.160 cm.
Lampadine: 1 x 70 W max - E27 HGS

E27 screw. Wire length 160 cm.
Bulbs: 1 x 70 W max - E27 HGS



Sospensione in metacrilato disponibile nei colori:

Methacrylate suspension lamp available in:

- CL 127 satinato, rosso, fumé e spectrall. opaline white, red, smoked grey and spectrall. 12 51
98 88
- CL 641 cromolite 55
- CL 130 texturgold 58
- CL 867 decoro nuance nei colori: rosso e grigio. natural opal version available in: red or grey. 53 91

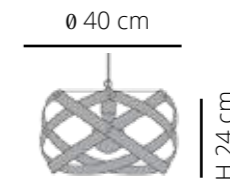

Attacco E27. Filo L.160 cm.
Lampadine: 1 x 70 W max - E27 HGS

E27 screw. Wire length 160 cm.
Bulbs: 1 x 70 W max - E27 HGS



NUVOLA

design by **Roberto Giacomucci**

CL 602

Sospensione in metacrilato, disponibile nei colori: satinato, rosso, fumé e spectrall.

Methacrylate suspension lamp available in: opaline white, red, smoked grey, and spectrall.

12 51 98 88



Ø 56 cm

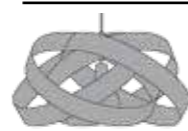

H 31 cm

Attacco E27. Filo L. 160 cm.
Lampadine : 1 x 70 W max - E27 HGS

E27 screw. Wire length cm 160.
Bulbs: 1 x 70 W max - E27 HGS



CL 603

Sospensione in metacrilato, disponibile nel colore: oro and cromolite. (44x44xH27 solo cromolite)

Methacrylate suspension lamp available in: gold and cromolite. (44x44xH27 only cromolite)

57 55

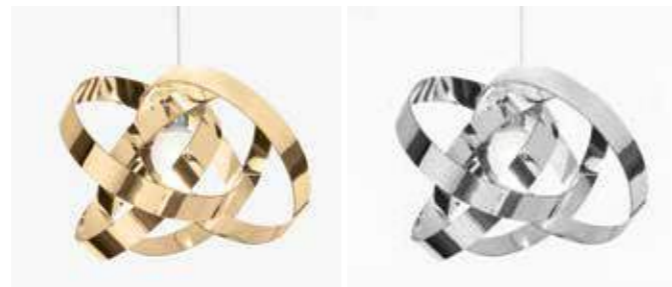

CL 692

Sospensione in metacrilato, disponibile nel colore: texturgold.

Methacrylate suspension lamp available in: texturgold.

58



CL 878

Sospensione in metacrilato, disponibile nella versione natural opal con decoro nuance nei colori: rosso e grigio.

Methacrylate suspension lamp.
Natural opal version available in: red or grey.

53 91

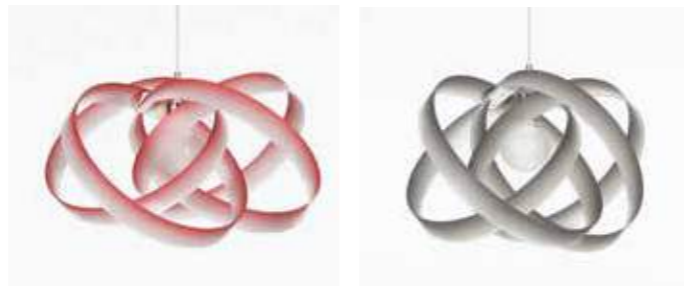

CL 880

Sospensione in metacrilato, disponibile nella versione bicolor: cromolite/satinato - gold/satinato. (54x44xH33 solo bicolor cromolite)

Methacrylate suspension lamp. Bicolor version available in: cromolite/opaline white - gold/opaline white. (54x44xH33 only bicolor cromolite)

95 97



ARFO'

design by **Alberto Vallesi**

CL 1491

*Sospensione in legno massello.
Disponibile nel colore noce.*

*Suspension lamp with wooden structure.
Available in: walnut.*

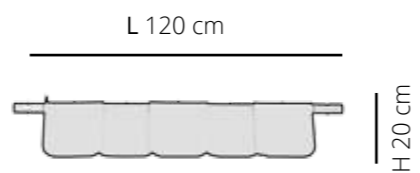

*Alimentata a strip led IP 20 - 24V - TOT. 20 W - 2400 Lumen.
Luce calda 3000 K + 5 %*

*Strip led IP 20 - 24V - TOT. 20 W - 2400 Lumen.
Warm light 3000 K + 5*



ARFO'

design by **Alberto Vallesi**

CL 1491

*Sospensione in legno massello.
Disponibile nel colore frassino.*

*Suspension lamp with wooden structure.
Available in: ash wood.*

70

L 120 cm



*Alimentata a strip led IP 20 - 24V - TOT. 20 W - 2400 Lumen.
Luce calda 3000 K + 5 %*

*Strip led IP 20 - 24V - TOT. 20 W - 2400 Lumen.
Warm light 3000 K + 5*



BABETTE

design by Roberto Giacomucci



CL 427

Sospensione con paralume conico in policarbonato antiriflesso con decoro nei colori: nero, bianco, oro e argento.

Polycarbonate suspension lamp with non-glare conical lampshade. Printed texture available in: black, white, gold and silver.

05 10 32 33

∅ 30 cm



H 27 cm

Attacco E27.
Filo L. 160 cm.
Lampadine: 1 x 70 W max - E27 HGS

E27 screw.
Wire length 160 cm.
Bulbs: 1 x 70 W max - E27 HGS



CL 428

Sospensione con paralume conico in policarbonato antiriflesso con decoro nei colori: nero, bianco, oro e argento.

Polycarbonate suspension lamp with non-glare conical lampshade. Printed texture available in: black, white, gold and silver.

05 10 32 33

∅ 42 cm



H 36 cm

Attacco E27.
Filo L. 160 cm.
Lampadine: 1 x 70 W max - E27 HGS

E27 screw.
Wire length 160 cm.
Bulbs: 1 x 70 W max - E27 HGS



BOEMIA

design by **Roberto Giacomucci**



CL 813

Sospensione con paralume conico in policarbonato con decoro diamantato nei colori: bianco, rosso, verde e grigio.

Polycarbonate suspension lamp with conical lampshade. Texture available in: white, red, green and grey.

10 51 20 91

∅ 30 cm

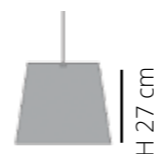

Attacco E27. Filo L.160 cm.
Lampadine: 1 x 70 W max - E27 HGS

E27 screw. Wire length 160 cm.
Bulbs: 1 x 70 W max - E27 HGS



CL 814

Sospensione con paralume conico in policarbonato con decoro diamantato nei colori: bianco, rosso, verde e grigio.

Polycarbonate suspension lamp with conical lampshade. Texture available in: white, red, green and grey.

10 51 20 91

∅ 42 cm



Attacco E27. Filo L.160 cm.
Lampadine: 1 x 70 W max - E27 HGS

E27 screw. Wire length 160 cm.
Bulbs: 1 x 70 W max - E27 HGS



CL 815

Sospensione con paralume conico a 3 luci in policarbonato con decoro diamantato nei colori: bianco, rosso, verde e grigio.

3 light polycarbonate suspension lamp with conical lampshade. Texture available in: white, red, green and grey.

10 51 20 91

∅ 66 cm



Attacco E27. Filo L.160 cm.
Lampadine: 3 x 53 W max - E27 HGS

E27 screw. Wire length 160 cm.
Bulbs: 3 x 53 W max - E27 HGS

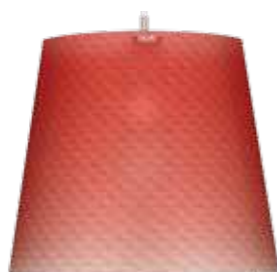

BOEMIA

design by **Roberto Giacomucci**

CL 816

Sospensione con paralume conico in policarbonato con decoro diamantato nei colori: bianco, rosso, verde e grigio.

*Polycarbonate suspension lamp with conical lampshade.
Texture available in: white, red, green and grey.*

∅ 25 cm



H 60 cm

Attacco E27. Filo L.160 cm.
Lampadine: 1 x 70 W max - E27 HGS

E27 screw. Wire length 160 cm.
Bulbs: 1 x 70 W max - E27 HGS



10 51 20 91



PIXI

design by **Roberto Giacomucci**

CL 204

Sospensione con paralume conico in policarbonato trasparente con decoro nei colori: nero, bianco, oro e argento.

Polycarbonate suspension lamp with transparent conical lampshade.
Printed texture available in: white, black, gold and silver.

05 10 32 33

∅ 30 cm



Attacco E27 Filo L.160 cm.
Bulbs: 1 x 70 W max - E27 HGS

E27 screw. Wire length 160 cm.
Bulbs: 1 x 70 W max - E27 HGS



PIXI

design by **Roberto Giacomucci**

CL 360

Sospensione con paralume conico in policarbonato trasparente con decoro nei colori: nero, bianco, oro e argento.

Polycarbonate suspension lamp with transparent conical lampshade.
Printed texture available in: white, black, gold and silver.

∅ 25 cm

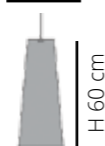

Attacco E27 Filo L.160 cm.
Bulbs: 1 x 70 W max - E27 HGS

E27 screw. Wire length 160 cm.
Bulbs: 1 x 70 W max - E27 HGS



05 10 32 33



PINOCCHIA

design by **Roberto Giacomucci**

CL 373

Sospensione con paralume conico in Sandyl pearl.

Polypropylene suspension lamp with white pearl conical lampshade.

15



∅ 40 cm



H 60 cm

Attacco E27. Filo L.160 cm.
Lampadine : 1 x 70 W max - E27 HGS

E27 screw. Wire length 160 cm.
Bulbs: 1 x 70 W max - E27 HGS



CL 372

Sospensione con paralume conico in Sandylex con stampa geometrica disponibile nei colori: grigio, giallo, rosso, azzurro.

Polypropylene suspension lamp. Printed texture lampshade available in: grey, red, yellow, blue.

91

21

51

61



DIDODADO

design by **Roberto Giacomucci**

Sospensione con paralume in PMMA disponibile nei seguenti colori:

Suspension lamp with PMMA lampshade available in:

12 98 88

CL 444 satinato, fumé e spectrall.



CL 625 cromolite

55



CL 409 texturgold

58



L 11 cm



H 18 cm

Attacco E27. Filo L. 160 cm.
Lampadine: 1 x 42 W max - E27 HGS

E27 screw. Wire length 160 cm.
Bulbs: 1 x 42 W max - E27 HGS



DIDODADO

design by **Roberto Giacomucci**

Sospensione barra a quattro elementi con paralume in PMMA nei seguenti colori:

Suspension lamp with PMMA lampshade available in:

CL 447 satinato, fumé e spectrall.

12 98 88



CL 628 cromolite

55



CL 412 texturgold

58

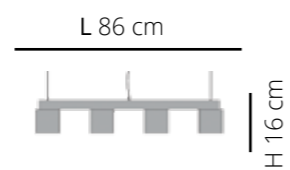

Attacco E27. Filo L.160 cm.
Lampadine: 4 x 42 W max - E27 HGS

E27 screw. Wire length 160 cm.
Bulbs: 4 x 42 W max - E27 HGS



DUO

design by **Walter Sbicca**

CL 1495

Sospensione 2 luci con paralumi in sandylex pearl.

2 light suspension lamp with pearl white sandylex lampshades.

15



CL 1496

Sospensione 2 luci con paralumi in sandylex, texture rosso e grigio.
(Possibile a richiesta unico colore)

2 light suspension lamp. Lampshades available in: red and grey.
(only one color upon request)

99

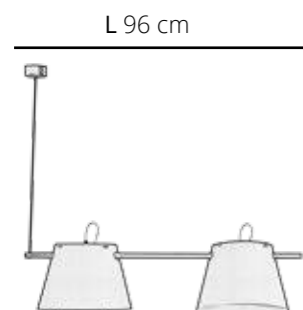

Attacco E 27 Filo L. 160 cm.
Lampadine : 2 X 53 W max - E 27 HGS

E 27 screw Wire length. 160 cm.
Bulbs : 2 X 53 W max - E 27 HGS



TRIO

design by **Walter Sbicca**

CL 1493

Sospensione 3 luci con paralumi in sandylex pearl.

3 light suspension lamp with pearl white sandylex lampshades.

15



CL 1492

Sospensione 3 luci con paralumi in sandylex, texture rosso, grigio e verde.
(Possibile a richiesta unico colore)

3 light suspension lamp. Lampshades available in: red, grey and green.
(only one color upon request)

99



L 150 cm



H 118 cm

Attacco E 27 Filo L. 160 cm.
Lampadine : 3 X 53 W max - E 27 HGS

E 27 screw Wire length. 160 cm.
Bulbs : 3 X 53 W max - E 27 HGS



FLORA

design by **Romeo Guaricci**

CL 1426

Sospensione in sandylex nel colore oropearl. Supporto in metacrilato trasparente.

Suspension lamp in sandylex, oropearl color.

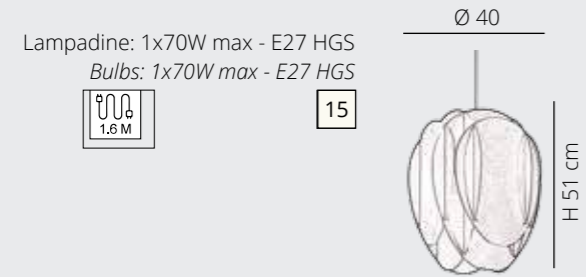

GROG

design by Roberto Giacomucci





CL 356

Sospensione con paralume conico in legnolene.

Suspension lamp with conical lampshade in legnolene.

Ø 13 cm



Attacco E27. Filo L 120 cm
disponibile nei colori: rosso e argento.
Lampadine: 1 x 70 W max - E27 HGS

Wire available in red and silver.
E27 screw. Wire length 120 cm.
Bulbs: 1 x 70 W max - E27 HGS

51 33



CL 355

Sospensione con paralume conico in legnolene.

Suspension lamp with conical lampshade in legnolene.

Ø 18 cm

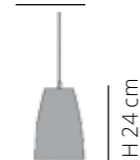

Attacco E27. Filo L 120 cm
disponibile nei colori: rosso e argento.
Lampadine: 1 x 70 W max - E27 HGS

Wire available in red and silver. E27 screw. Wire
length 120 cm.
Bulbs: 1 x 70 W max - E27 HGS

51 33



CL 358
Pendel rotondo a 3 elementi. Paralumi in legnolene.
Supporto rotondo in metallo verniciato bianco.
3 light rounded pendel, conical lampshade in legnolene.

Attacco E27. Filo L 120 cm
disponibile nei colori: rosso e argento.
Lampadine: 3 x 53 W max - E27 HGS

Wire available in red and silver.
E27 screw. Wire length 120 cm.
Bulbs: 3 x 53 W max - E27 HGS



51 33

Ø 38 cm



H 22 cm



CL 357
Pendel rettangolare a 3 elementi. Paralumi in legnolene.
3 light rectangular pendel, conical lampshade in legnolene.

Attacco E27. Filo L 120 cm
disponibile nei colori: rosso e argento.
Lampadine: 3 x 53 W max - E27 HGS

Wire available in red and silver.
E27 screw. Wire length 120 cm.
Bulbs: 3 x 53 W max - E27 HGS



51 33

L 83 cm

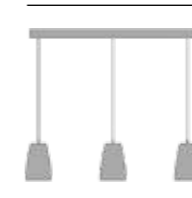

H 22 cm



RELOAD

design by **Roberto Giacomucci**

CL 406

*Sospensione con paralume in materiale plastico termofuso di cui una parte derivante dal processo di riciclo.
Disponibile nei colori bianco o multicolor.*

*Suspension lamp partially made from recycled plastic.
Available in white or multicolour.*

10,99

Ø 48



H 52 cm

Attacco E27. Filo L. 160 cm.
Lampadine: 1 x 70 W max - E27 HGS

E27 screw. Wire length 160 cm.
Bulbs: 1 x 70 W max - E27 HGS

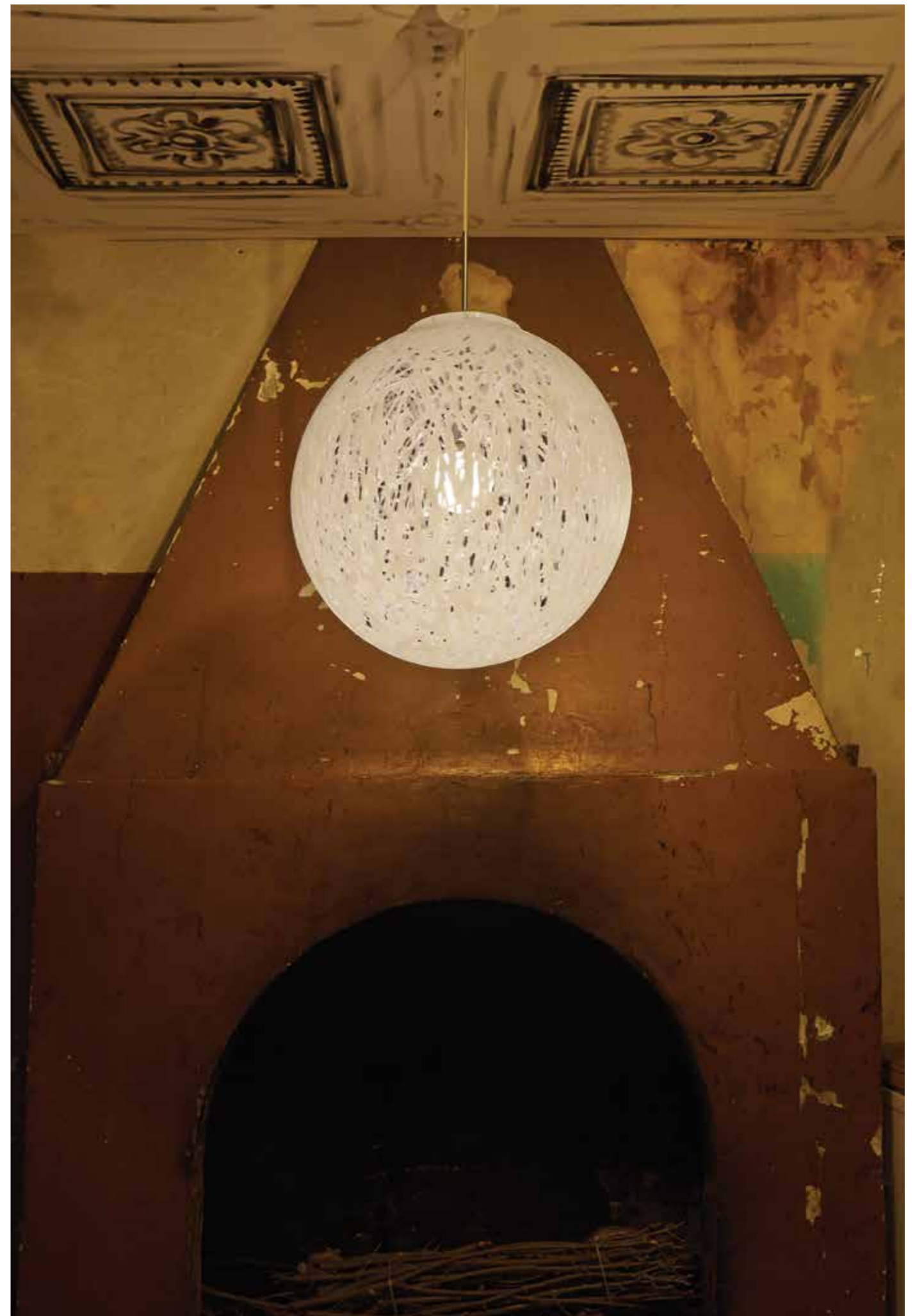

RICCIOLO

design by **Roberto Giacomucci**

CL 909

Sospensione in metacrilato, disponibile nei colori: trasparente, satinato, fumé e spectrall.

Methacrylate suspension lamp available in: transparent, opaline white, smoked grey and spectrall.

11 12 98 88



CL 656

Sospensione in metacrilato, disponibile nel colore: cromolite.

Methacrylate suspension lamp available in: cromolite.

55



CL 926

Sospensione in metacrilato, disponibile nel colore: texturgold.

Methacrylate suspension lamp available in: texturgold.

58



CL 877

Sospensione in metacrilato, disponibile nella versione natural opal con decoro nuance nei colori: rosso e grigio.

Methacrylate suspension lamp.
Natural opal version available in: red or grey.

53 91

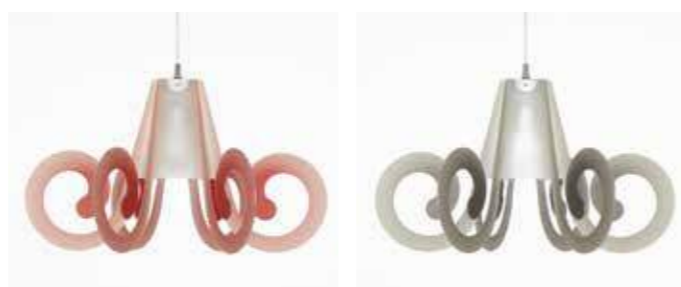

Ø 75 cm



H 43 cm

Attacco E27. Filo L. 160 cm.
Lampadine : 1 x 70 W max - E27 HGS

E27 screw. Wire length cm 160.
Bulbs: 1 x 70 W max - E27 HGS

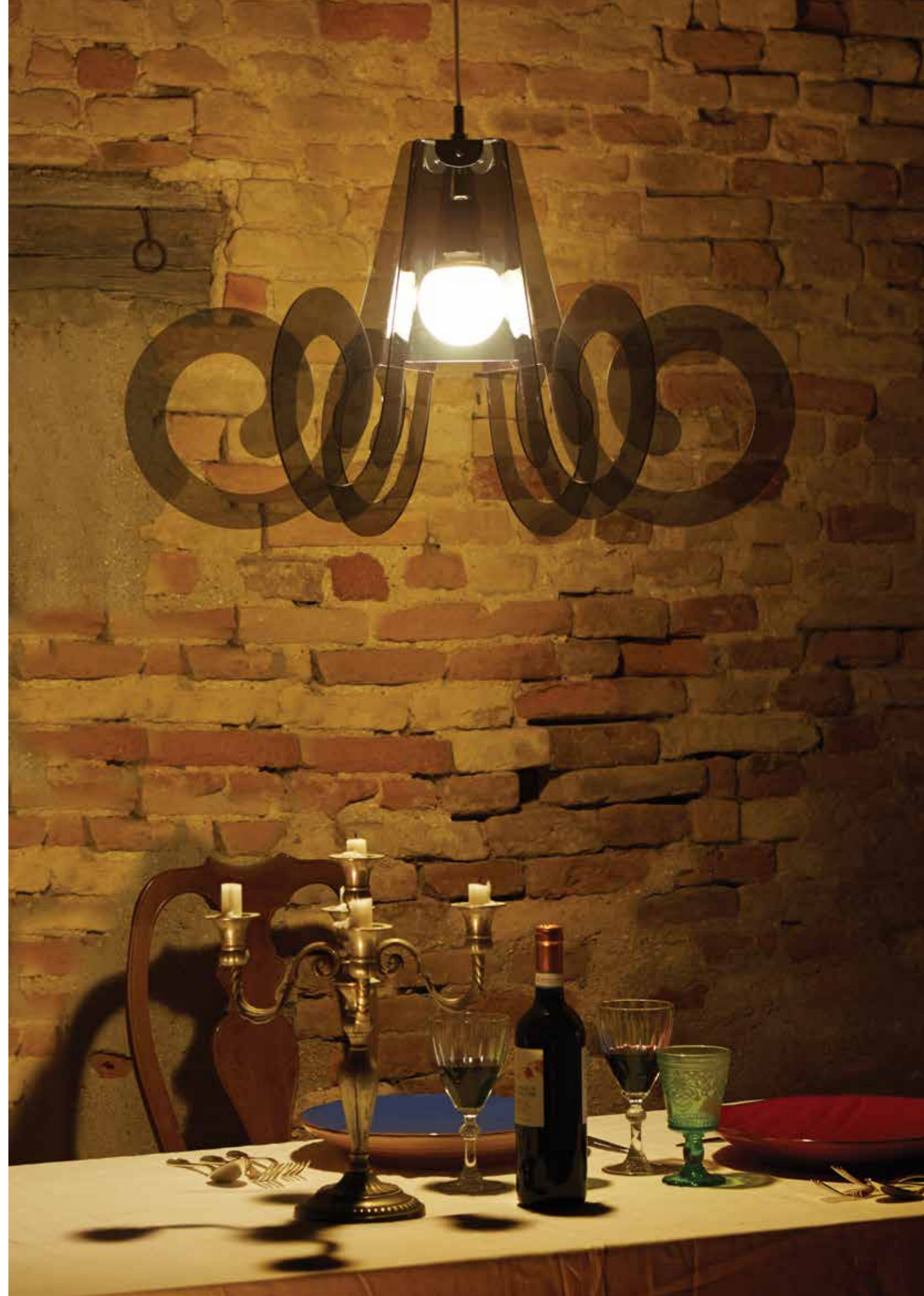

RICCIOLINO

design by **Roberto Giacomucci**

CL 908

Sospensione in metacrilato, disponibile nei colori: trasparente, satinato, fumé e spectrall.

Methacrylate suspension lamp available in: transparent, opaline white, smoked grey and spectrall.

11 12 98 88



CL 655

Sospensione in metacrilato, disponibile nel colore: cromolite.

Methacrylate suspension lamp available in: cromolite.

55



CL 925

Sospensione in metacrilato, disponibile nel colore: texturgold.

Methacrylate suspension lamp available in: texturgold.

58



CL 876

Sospensione in metacrilato, disponibile nella versione natural opal con decoro nuance nei colori: rosso e grigio.

Methacrylate suspension lamp. Natural opal version available in: red or grey.

53 91



Ø 55 cm



H 32 cm

Attacco E27. Filo L. 160 cm.
Lampadine : 1 x 70 W max - E27 HGS

E27 screw. Wire length cm 160.
Bulbs: 1 x 70 W max - E27 HGS



RIGATONE

design by Roberto Giacomucci

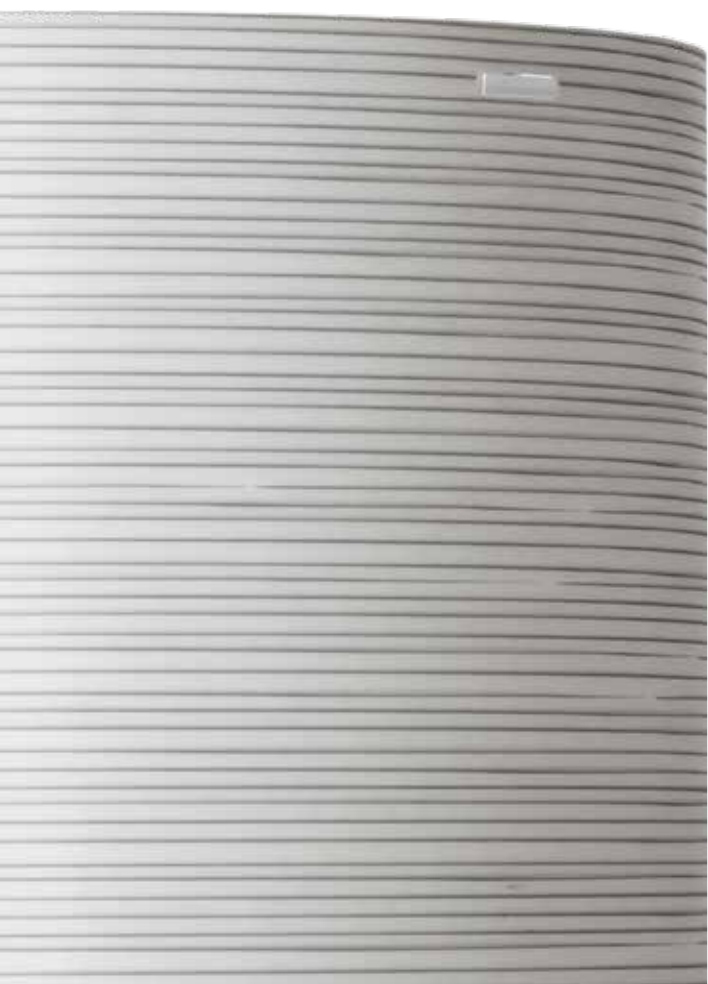

RIGATONE

design by **Roberto Giacomucci**

CL 885

Sospensione con paralume cilindrico in polipropilene bianco perla con decoro fili. Struttura in metacrilato finitura spectrall e satinato.

Suspension lamp. White pearl cylindrical polypropylene lampshade with thread texture. Methacrylate structure in spectrall and opaline white finish.

89



Ø 30 cm



H 19,6 cm

Attacco E27. Filo L 160 cm.
Lampadine: 1 x 70 W max - E27 HGS

E27 screw. Wire length 160 cm.
Bulbs: 1 x 70 W max - E27 HGS



CL 886

Sospensione con paralume cilindrico in polipropilene bianco perla con decoro fili. Struttura in metacrilato finitura spectrall e satinato.

Suspension lamp. White pearl cylindrical polypropylene lampshade with thread texture. Methacrylate structure in spectrall and opaline white finish.

89



Ø 45 cm

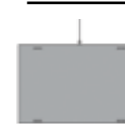

H 29 cm

Attacco E27. Filo L 160 cm.
Lampadine: 2 x 53 W max - E27 HGS

E27 screw. Wire length 160 cm.
Bulbs: 2 x 53 W max - E27 HGS



RIGATONE

design by **Roberto Giacomucci**

CL 887

Sospensione con paralume cilindrico in polipropilene bianco perla con decoro fili. Struttura in metacrilato finitura spectrall e satinato.

Suspension lamp. White pearl cylindrical polypropylene lampshade with thread texture. Methacrylate structure in spectrall and opaline white finish.

89



Ø 60 cm

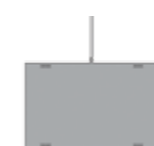

H 37,5 cm

Attacco E27. Filo L 160 cm.
Lampadine: 3 x 53 W max - E27 HGS

E27 screw. Wire length 160 cm.
Bulbs: 3 x 53 W max - E27 HGS



CL 888

Sospensione con paralume cilindrico in polipropilene bianco perla con decoro fili. Struttura in metacrilato finitura spectrall e satinato.

Suspension lamp. White pearl cylindrical polypropylene lampshade with thread texture. Methacrylate structure in spectrall and opaline white finish.

89



Ø 17 cm



H 38 cm

Attacco E27. Filo L 160 cm.
Lampadine: 1 x 70 W max - E27 HGS

E27 screw. Wire length 160 cm.
Bulbs: 1 x 70 W max - E27 HGS



TRACK

design by **Roberto Giacomucci**

TRACK 9 - CL 382

Sospensione in metacrilato effetto satinato. Spessore 15 mm.

Methacrylate suspension lamp in opaline white effect color.
Thickness: 15 mm.

12

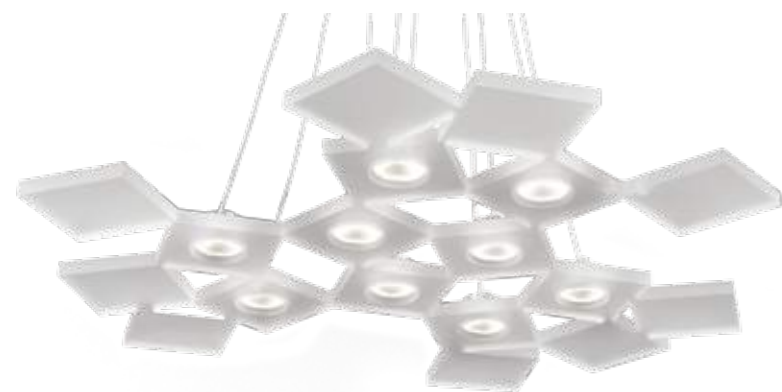

L 67 cm

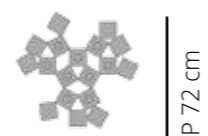

Fili L.200 cm.
Cablaggio LED 36W - 220 V
Lumen 3.780 °K LED 3000

Wire length 200 cm.
Wiring LED 36W - 220 V
Lumen 3.780 °K LED 3000



TRACK 8 - CL 380

Sospensione in metacrilato effetto satinato. Spessore 15 mm.

Methacrylate suspension lamp in opaline white effect color.
Thickness: 15 mm.

12



L 91 cm



Fili L.200 cm.
Cablaggio LED 32W - 220 V
Lumen 3.360 °K LED 3000

Wire length 200 cm.
Wiring LED 32W - 220 V
Lumen 3.360 °K LED 3000



TRACK 3 - CL 364

Sospensione in metacrilato effetto satinato. Spessore 15 mm.

Methacrylate suspension lamp in opaline white effect color.
Thickness: 15 mm.

12



L 27 cm



Fili L.200 cm.
Cablaggio LED 12W - 220 V
Lumen 1.260 °K LED 3000

Wire length 200 cm.
Wiring LED 12W - 220 V
Lumen 1.260 °K LED 3000



LELLE

design by **Roberto Giacomucci**

CL 384

Sospensione in metacrilato effetto satinato. Spessore 15mm.

Methacrylate suspension lamp in opaline white. Thickness 15 mm.

12

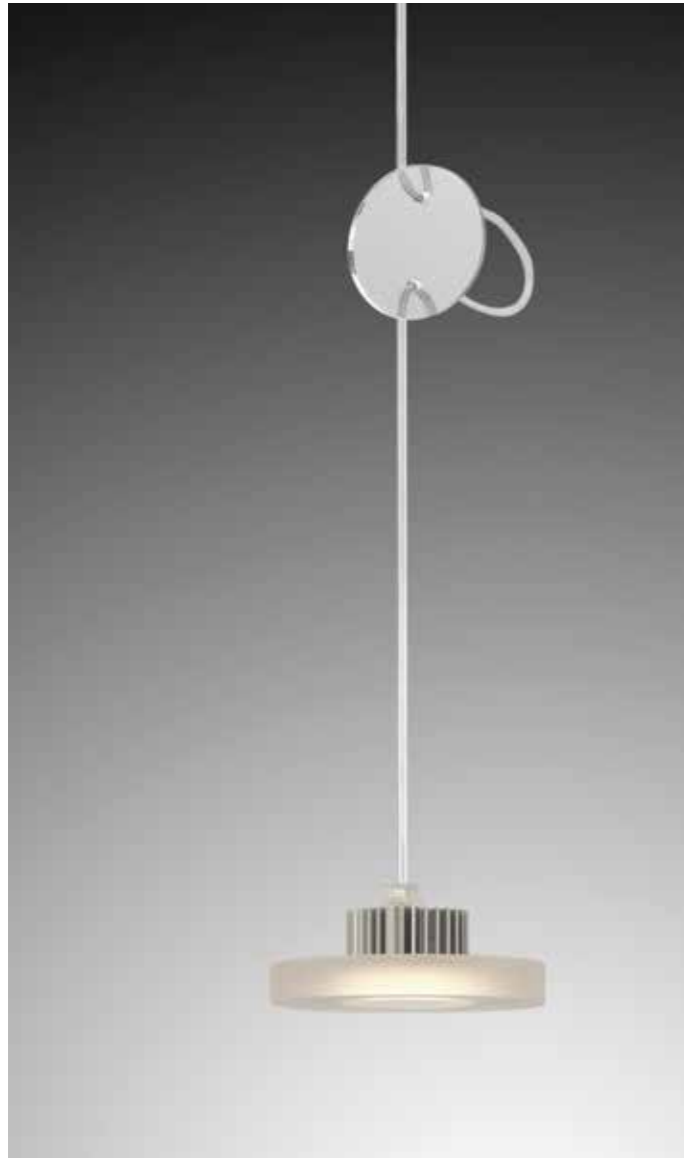

Filo L. 200 cm.
Cablaggio LED 4W - 220 V
Lumen 420 °K LED 3000

Wire length 200cm.
Wiring LED 4W - 220 V
Lumen 420 °K LED 3000

∅ 10 cm



H 4,5 cm



CANDY

design by **UTE**

CL 143

Sospensione di grandi dimensioni a 3 luci. semisfera in metacrilato opal diffusore spessore 8 mm.

3 light suspension lamp. Opal diffuser methacrylate dome 8mm thickness.

10



CL 144

Sospensione di grandi dimensioni a 3 luci. semisfera in metacrilato opal diffusore spessore 8 mm.
Colori a scelta

3 light suspension lamp. Opal diffuser methacrylate dome 8mm thickness.

10



∅ 143 cm

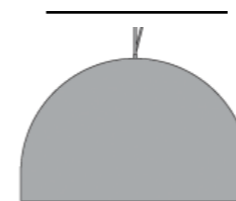

H 70 cm

Attacco E27
Filo e cavi di sospensione in acciaio cm 200.
Lampadine: 3 x 53 W max - E27 HGS

E27 screw
Wire and steel suspension cables length 200 cm.
Bulbs: 3 x 53 W max - E27 HGS

BRUNELLA

design by **Roberto Giacomucci**

CL 395

Sospensione 3 luci. Cupola in metacrilato diffusore, disco in metacrilato satinato.

3 light suspension lamp. Methacrylate lampshade with opaline white methacrylate disc.

12



Ø 62 cm

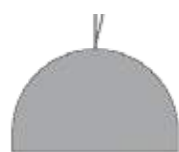

H 42 cm

Attacco E27. Filo L.160 cm.
Lampadine: 3 x 53 W max - E27 HGS

E27 screw. Wire length 200cm.
Bulbs: 3 x 53 W max - E27 HGS



UBI

design by **Roberto Giacomucci**

CL 391 - FIORI

Sospensione con cilindro in metacrilato rasterizzato. Supporto in acciaio con trattamento galvanico. Disponibile nelle versioni: cromo, oro e rame.

Suspension lamp with raster methacrylate cylinder. Steel fitting. Texture available in: chrome, gold and copper.

34 35 36



CL 392 - FILI

Sospensione con cilindro in metacrilato rasterizzato. Supporto in acciaio con trattamento galvanico. Disponibile nelle versioni: cromo, oro e rame.

Suspension lamp with raster methacrylate cylinder. Steel fitting. Texture available in: chrome, gold and copper.

34 35 36



Ø 10 cm



H 36 cm

Attacco : GX53-1
Lampadine 1 X 9 W - GX 53 - 1 LED
Lampadine 1 X 7 W - GX 53 - 1 FB
(1 lampadina inclusa.)

GX53-1 screw
Bulbs 1 X 9 W - GX 53 - 1 LED
Bulbs 1 X 7 W - GX 53 - 1 FB D
(1 Bulb included.)



TRILLY

design by **Roberto Giacomucci**

CL 551

Sospensione realizzata in materiale acrilico disponibile nei colori: trasparente, verde, rosso, blu, fumé.

Suspension lamp in acrylic material available in: transparent, green, red, blue and smoked grey.



∅ 20 cm

Attacco E27. Filo L.160 cm.
Lampadine: 1 x 70 W max - E27 HGS



H 21 cm

E27 screw. Wire L 160 cm.
Bulbs: 1 x 70 W max - E27 HGS



CL 552

Sospensione realizzata in materiale acrilico disponibile nei colori: trasparente, verde, rosso, blu, fumé.

Suspension lamp in acrylic material available in: transparent, green, red, blue and smoked grey.



∅ 20 cm

Attacco E27. Filo L.160 cm.
Lampadine: 1 x 70 W max - E27 HGS



H 21 cm

E27 screw. Wire L 160 cm.
Bulbs: 2 x 53 W max - E27 HGS



CL 553

Sospensione realizzata in materiale acrilico disponibile nei colori: trasparente, verde, rosso, blu, fumé.

Suspension lamp in acrylic material available in: transparent, green, red, blue and smoked grey.



∅ 20 cm

Attacco E27. Filo L.160 cm.
Lampadine: 1 x 70 W max - E27 HGS



H 21 cm

E27 screw. Wire L 160 cm.
Bulbs: 3 x 53 W max - E27 HGS



CUPOLA

design by Brian Rasmussen

CL 1460

Lampada da terra per esterni in sandylex colore bianco pearl.

Outdoor floor lamp in white pearl sandylex.

15

Ø 30
H 45 cm
IP 44
Attacco E27.
Lampadine: 1 x 70 W max - E27 HGS



CL 1459

Lampada da terra per esterni in sandylex colore bianco pearl.

Outdoor floor lamp in white pearl sandylex.

15

Ø 60
H 100 cm
IP 44
Attacco E27.
Lampadine: 2 x 70 W max - E27 HGS



RELOAD

design by **Roberto Giacomucci**

CL 443

Lampada da terra per esterni con paralume in materiale plastico termofuso di cui una parte derivante dal processo di riciclo. Disponibile nei colori bianco o multicolor.

Outdoor floor lamp . Lampshade partially made from recycled plastic. Available in white or multicolour.

10 99

Ø 48



H 52 cm

IP 44. Attacco E27.
Lampadine: 1 x 70 W max - E27 HGS

IP 44. E27 screw.
Bulbs: 1 x 70 W max - E27 HGS



Colori_Colours

- 05 Nero/Black
- 10 Bianco/White
- 11 Trasparente/Transparent
- 12 Bianco satinato/Opaline white
- 14 Bianco matt/Matt white • Natural opal
- 15 Bianco perla/Pearl white
- 16 Decoro righe bianco/White stripes decoration
- 20 Verde/Green
- 21 Giallo/Yellow
- 23 Verde Fluorescente/Fluorescent green
- 29 Viola/Violet
- 32 Oro/Gold
- 33 Argento/Silver
- 34 Cromato/Chromed
- 35 Dorato/Golden
- 36 Rame/Copper
- 41 Arancio/Orange
- 43 Arancio Fluorescente/Fluorescent orange
- 48 Rosa/Pink
- 49 Fucsia/Fuchsia
- 51 Rosso/Red
- 53 Nuance Rosso/Nuance Red
- 55 Cromolite
- 57 Oro/Gold
- 58 TexturGold
- 59 Bronzo/Bronze
- 61 Blu/Blue
- 63 Celeste/Light blue
- 67 Tessuto intrecciato
- 70 Frassino/Ash wood
- 71 Noce/Walnut
- 82 Trama nero/Texture black
- 83 Trama rosso/Texture red
- 88 Spectrall
- 89 Decoro fili/Thread-like decoation
- 91 Nuance grigio/Nuance gray
- 93 Macchie nero/Black spots
- 94 Grigio matt/Matt gray • Grigio opal/Gray opal
- 95 Bicolor bianco satinato/cromolite
Bicolor opaline white/cromolite
- 96 Quadri grigio/Grey checks
- 97 Bicolor bianco satinato/oro
Bicolor opaline white/gold
- 98 Fume'
- 99 Multicolor/Multicolour

DESIGNERS

UTE EMPORIUM
WALTER SBICCA
ROMEO GUARICCI
LETIZIA MAMMINI
VALERIA CANDIDO
ROBERTO GIACOMUCCI
MELISSA GIACCHI
BRIAN RASMUSSEN
ALBERTO VALLESI

AD WALTER SBICCA

PHOTO ANDREA BELLEZZA - GIULIA LOCCIONI

GRAPHIC DESIGN UFFICIO TECNICO EMPORIUM - GABRIELE PIERINI - ANDREA BELLEZZA

Tutti i prodotti sono **MADE IN ITALY**
*All products are **MADE IN ITALY***



EMPORIUM

Emporium srl - C/da Marolino - S.S. Regina Km 6,5 - 62018 Potenza Picena (MC) ITALY
Tel. (+39) 0733 671747 - Fax. (+39) 0733 870081
emporium@emporium.it - www.emporium.it



PIXI

design by **Roberto Giacomucci**

CL 205

Sospensione con paralume conico in policarbonato trasparente con decoro nei colori: nero, bianco, oro e argento.

Polycarbonate suspension lamp with transparent conical lampshade. Printed texture available in: white, black, gold and silver.

05 10 32 33

Ø 42 cm

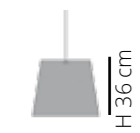

Attacco E27 Filo L.160 cm.
Bulbs: 1 x 70 W max - E27 HGS

E27 screw. Wire length 160 cm.
Bulbs: 1 x 70 W max - E27 HGS

