



YOUR LIGHT



INTERIOR LIGHTING
4 – 185















BATHROOM
186 – 247



SYSTEMS
248 – 273



LIGHT IS OUTSIDE
274 – 349

-  eingebaute LED
built-in LED
-  Fassung für austauschbare Leuchtmittel
socket for exchangeable bulbs
-  dimmbar
dimmable
-  inklusive Dimmer
dimmer included
-  inklusive Fernbedienung
remote control included
-  Smart Home Steuerung optional
smart home control optionally
-  inklusive Schalter
switch on/off included
-  Höhe einstellbar
Height adjustable
-  stufenlose Höhenverstellung
height infinitely adjustable
-  EASY-LIFT Höhenverstellung
EASY-LIFT height adjustment
-  inklusive Bewegungsmelder
motion sensor included
-  Schutzart
protective rating
-  Y.L.
Plus



INTERIOR LIGHTING

INSIDE

Leuchtenübersicht Innenleuchten
Overview interior lighting

NEW

INDEX

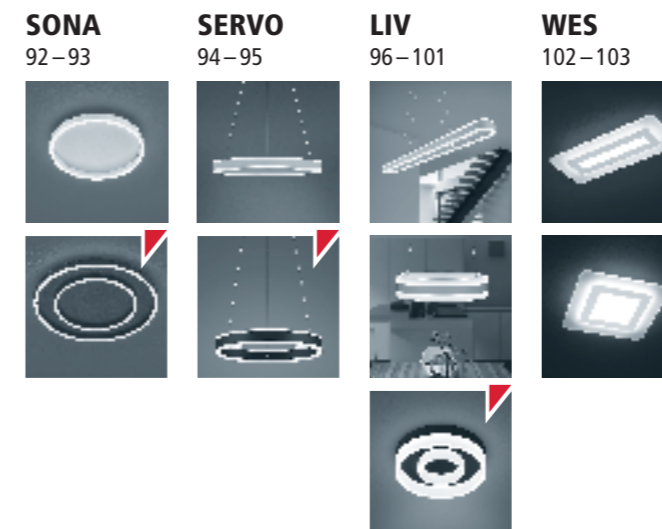
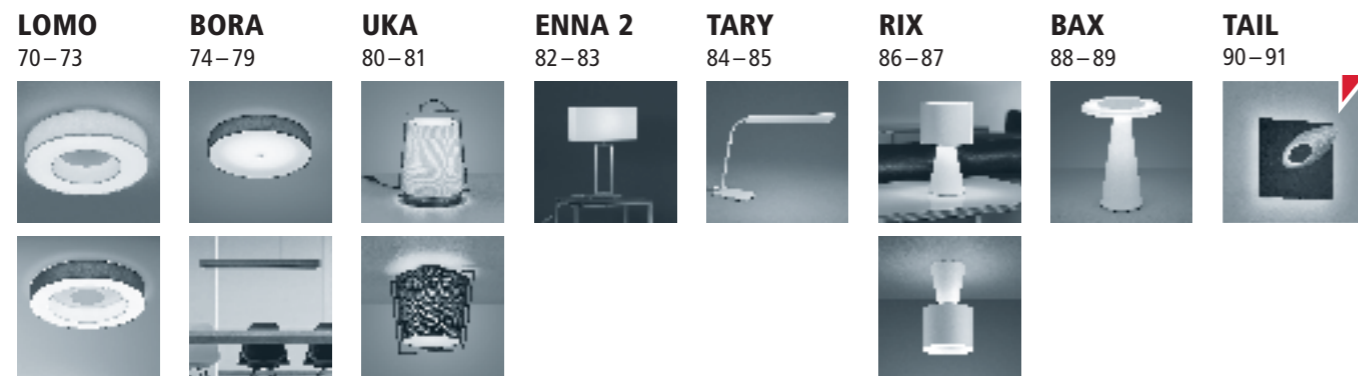
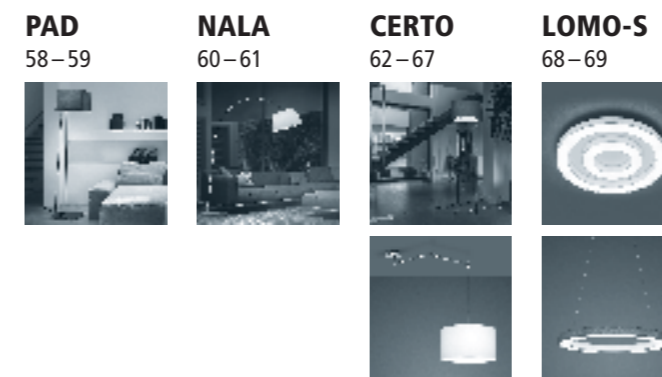
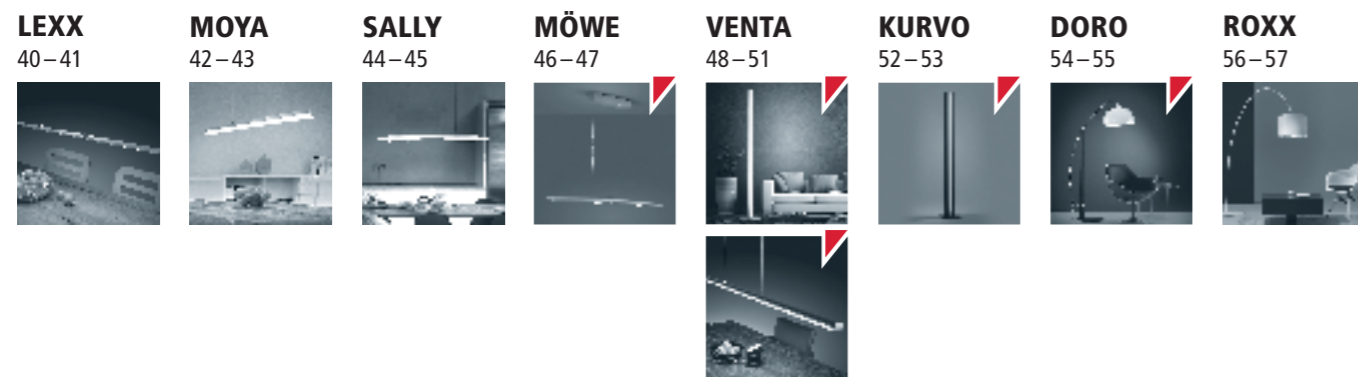
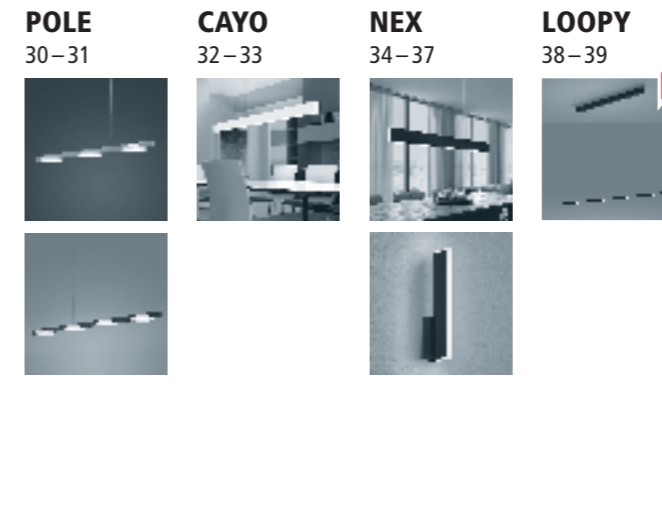
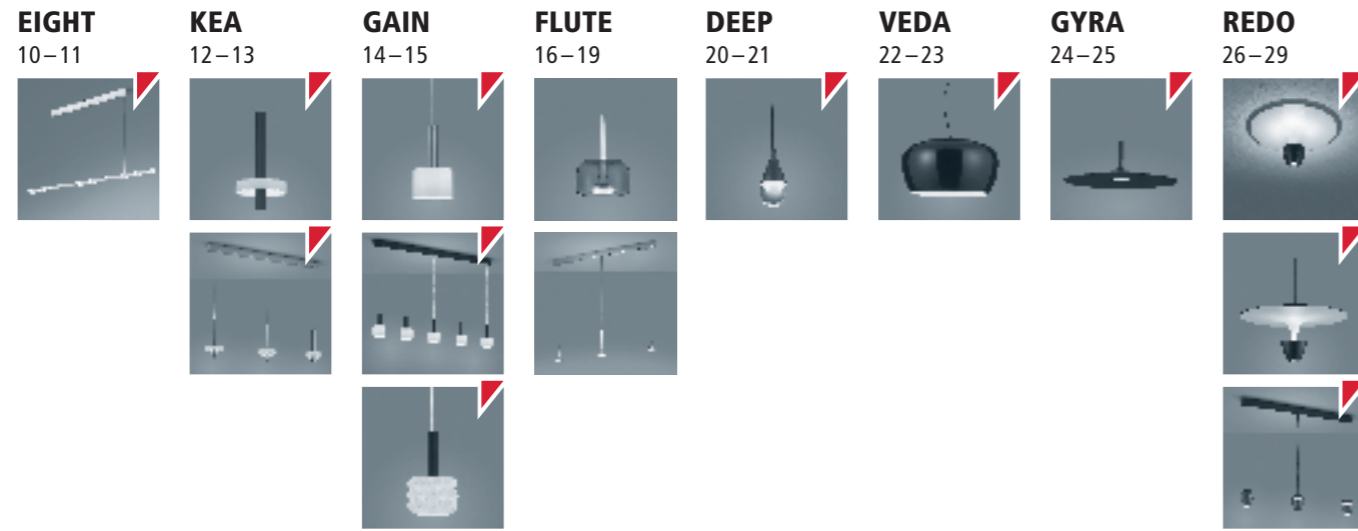

ADEO	130-131
ALLY	144-145
BAX	88-89
BORA	74-79
CANIO	120-121
CAS	164-165
CAYO	32-33
CERTO	62-67
COR	128-129
COSI	108-111
DEEP	20-21
DEX	126-127
DORA	146-147
DORO	54-55
EIGHT	10-11
ENIO	152-153
ENNA 2	82-83
FLUTE	16-19
FOSCA	136-137
GAIN	14-15
GOTO	162-163
GYRA	24-25
JENNA	104-105
KARI	148-151
KEA	12-13
KURVO	52-53
LEXX	40-41
LICA	116-117
LIV	96-101
LOMO	70-73
LOMO-S	68-69
LOOPY	38-39
LUG	178-179
MÖWE	46-47
MOYA	42-43
NALA	60-61
NEX	34-37
NOG	156-157
NUT	160-161
ONNO	134-135
ONTO	180-181
PAD	58-59
PAIR	154-155
PAX	166-167
PIC	174-175
POLE	30-31
PONT	138-139 / 168-169
RACK	112-115
REDO	26-29
RIWA	158-159
RIX	86-87
ROTA	170-173
ROXX	56-57
SALLY	44-45
SENT	182-183
SERVO	94-95
SIMO	122-123
SIRI	140-141
SIRI LED	142-143
SKA	176-177
SONA	92-93
STAY	124-125
TAIL	90-91
TANA	118-119
TARY	84-85
UKA	80-81
VADA	106-107
VEDA	22-23
VENTA	48-51
WES	102-103
YONA	132-133

Leuchtenübersicht Innenleuchten
Overview interior lighting

NEW

INDEX

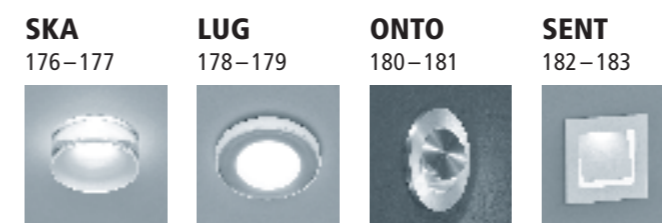
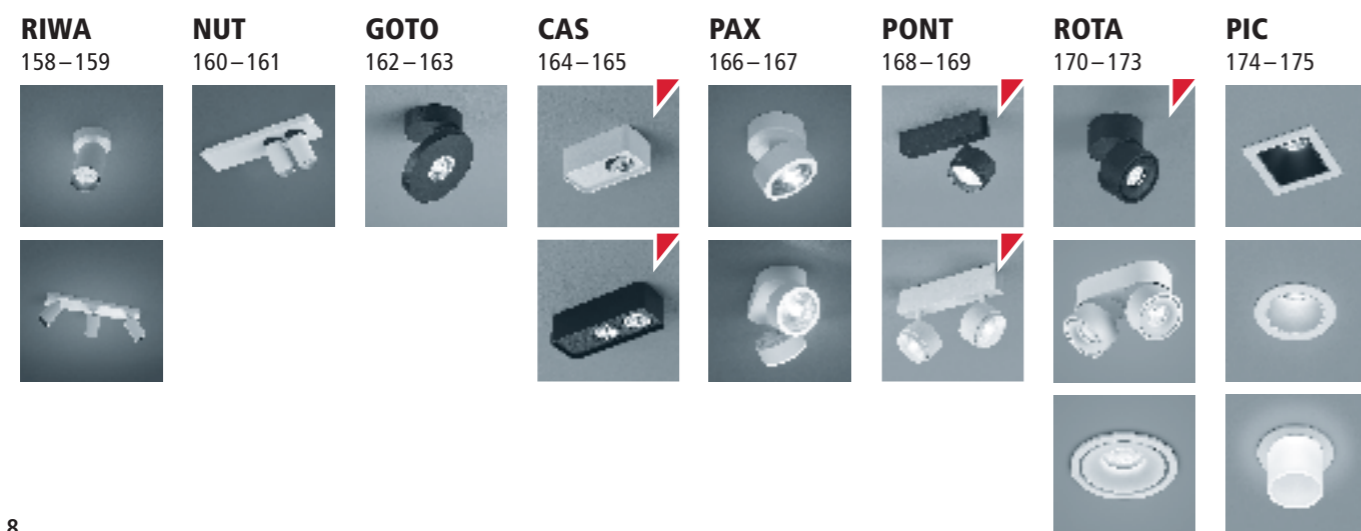
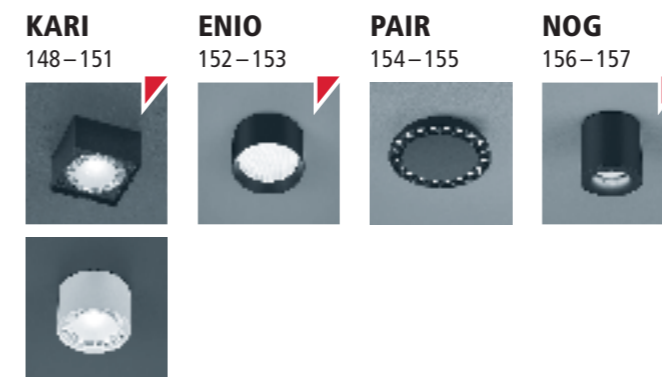
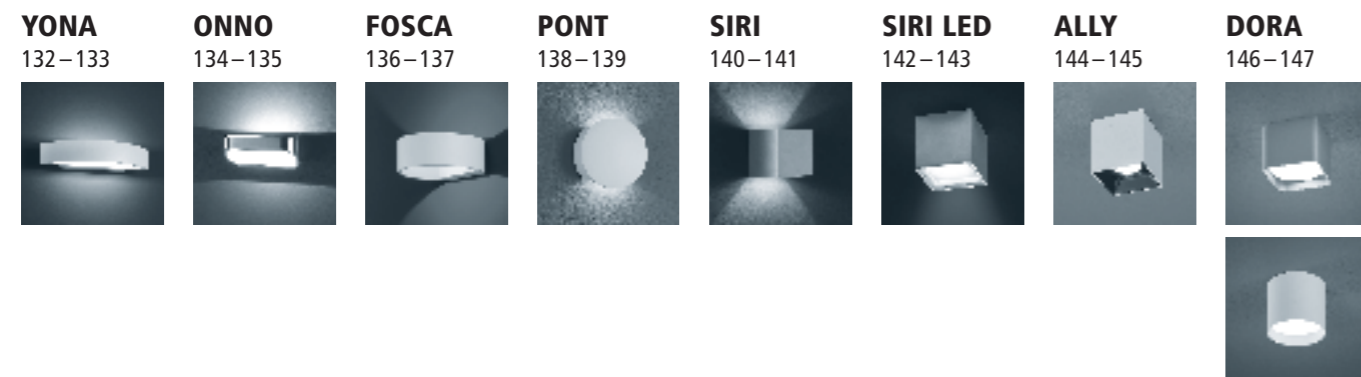
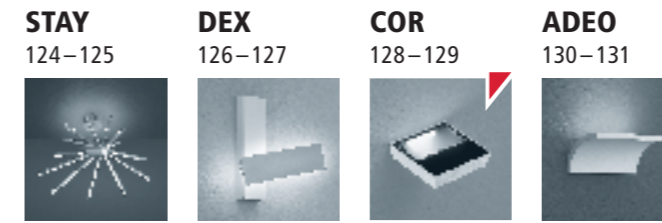
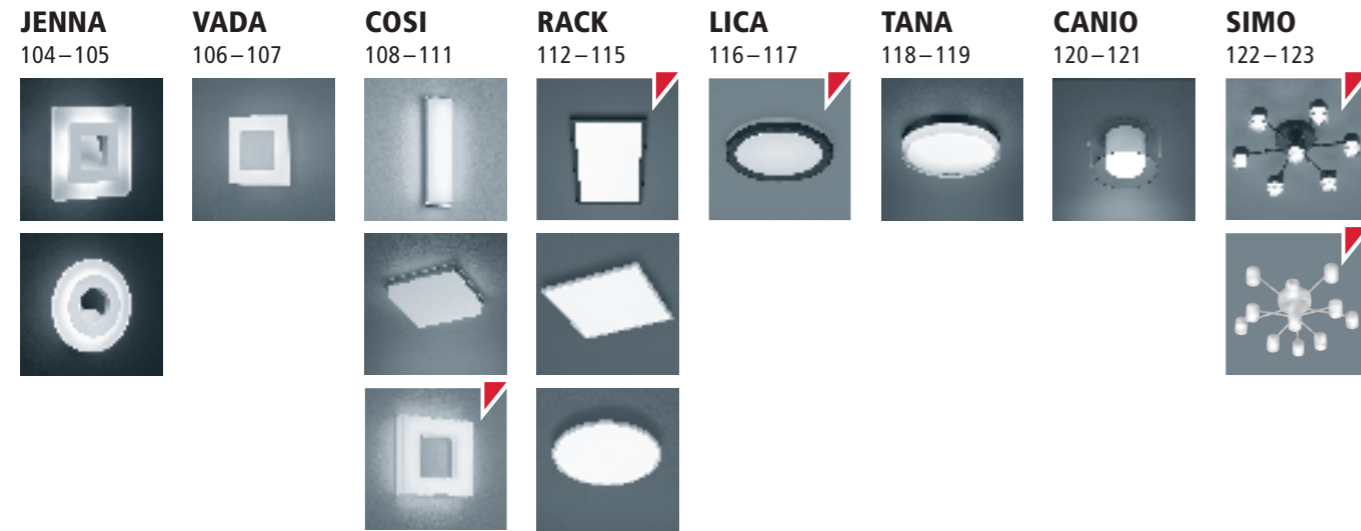



EIGHT

LED    

Acrylglas satiniert
acrylic diffuser satinised

28 W, 2700 K, B 3490 / N 1850 lm, CRI > 90



mattweiß / white mat

16/2214.07

mattschwarz / black mat

16/2214.22

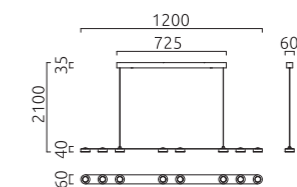

KEA

LED   IP20

Glas opal weiß
Abstrahlwinkel 50°
glass opal white
beam angle 50°



10 W, 2700 K, B 1060 / N 570 lm, CRI > 90

mattnickel / nickel mat
26/2108.06/5303

mattschwarz / black mat
26/2108.22/5303

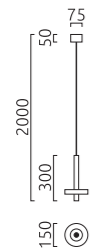

32 W, 2700 K, B 3450 / N 1710 lm, CRI > 90

mattnickel / nickel mat
66/2108.06/5303

mattschwarz / black mat
66/2108.22/5303

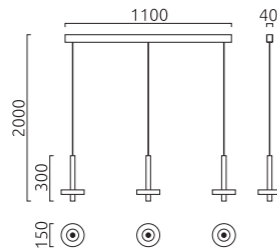



GAIN

E14 ↑ IP20

Glas opal weiß
glass opal white

Leuchtmittel nicht im Lieferumfang
bulb not included



1 x E14
mattnickel / nickel mat
16/2104.06/5306
mattschwarz / black mat
16/2104.22/5306



3 x E14
mattnickel / nickel mat
36/2104.06/5306
mattschwarz / black mat
36/2104.22/5306

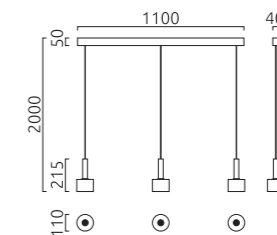

5 x E14
mattnickel / nickel mat
56/2104.06/5306
mattschwarz / black mat
56/2104.22/5306

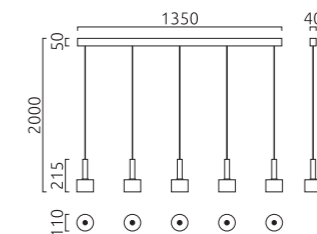

FLUTE

LED   IP20

chrom
Acryldiffusor satiniert
optional Glas klar oder grau
chrome
acrylic diffuser satinised
optional glass clear or grey

Gläser bitte separat bestellen /
please order glasses separately
5284 Glas klar / glass clear
5285 Glas grau / glass grey



8 W, 2800 K, B 880 / N 570 lm, CRI > 90
16/2001.04

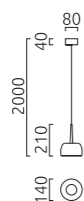

19 W, 2800 K, B 2140 / N 1320 lm, CRI > 90
36/2002.04

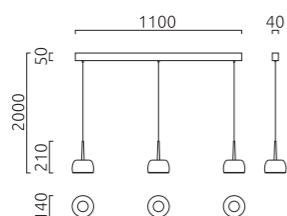



FLUTE

LED   IP20

chrom
Acryldiffusor satiniert
chrome
acrylic diffuser satinised



8 W, 2800 K, B 880 / N 570 lm, CRI > 90
16/2001.04

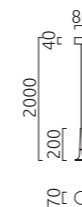

19 W, 2800 K, B 2140 / N 1320 lm, CRI > 90
36/2002.04

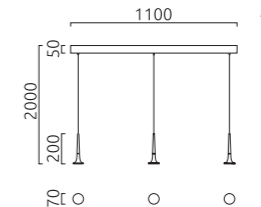



mattgold / gold mat
16/2110.09
 mattschwarz / black mat
16/2110.22



DEEP

LED ↑ IP20

Glas teilsatiniert
 glass partially satinised

5,5 W, 2700 K, B 570 / N 450 lm, CRI > 95



www.helestra.de/deep

VEDA

E27 ↑ IP20

mattschwarz eloxiert
black mat anodised

1 x E27



Opalglas weiß / glass opal white

16/2107.22/5300

Opalglas schwarz lackiert / glass opal black lacquered

16/2107.22/5301

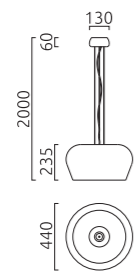

Leuchtmittel nicht im Lieferumfang
bulb not included





GYRA

LED   IP20

mattschwarz
Acryldiffusor satiniert
black mat
acrylic diffuser satinised

13 W, 2700 K, B 1380 / N 910 lm, CRI > 85



16/2127.22

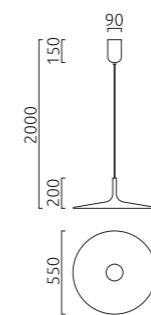



REDO

LED  IP20

schwarz - weiß
Abstrahlwinkel 60°
black - white
beam angle 60°



7,5 W, 2700 K, B 820 / N 540 lm, CRI > 90
25/2117.62



12 W, 2700 K, B 1320 / N 830 lm, CRI > 90
25/2118.62

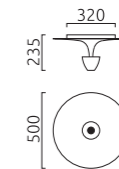

12 W, 2700 K, B 1320 / N 830 lm, CRI > 90
26/2118.62

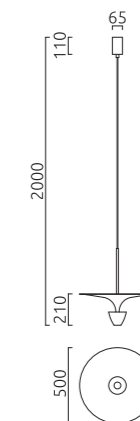

REDO

LED   IP20

schwarz - weiß
Abstrahlwinkel 60°
black - white
beam angle 60°

11 W, 2700 K, B 1220 / N 650 lm, CRI > 90
26/2119.62

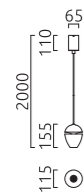

32 W, 2700 K, B 3660 / N 1950 lm, CRI > 90
66/2119.62

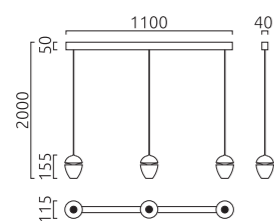

POLE

LED    IP20

Glas satiniert
glass satinised



28 W, 2700 K, B 3940 / N 2160 lm, CRI > 90
mattnickel eloxiert / nickel mat anodised
36/1901.18
mattschwarz eloxiert / black mat anodised
36/1901.22

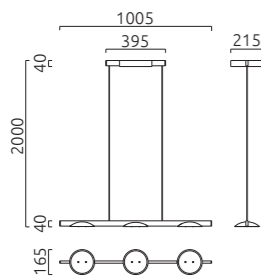

41 W, 2700 K, B 5250 / N 2880 lm, CRI > 90
mattnickel eloxiert / nickel mat anodised
46/1901.18
mattschwarz eloxiert / black mat anodised
46/1901.22

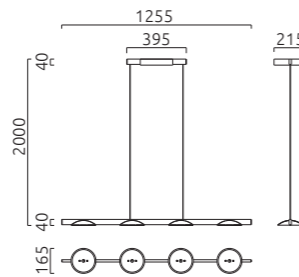

CAYO

LED   IP20 

inkl. Sensordimmer (Gestensteuerung)
Up- und Downlight getrennt schalt- und dimmbar
dimmable with gesture control
Up- and Downlight separatly controllable

50 W, 2700 K, B 5780 / N 2250 lm, CRI > 90



mattweiß / white mat
26/2009.07

mattschwarz / black mat
26/2009.22

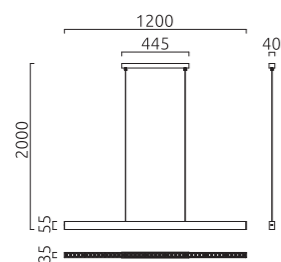

NEX

LED    IP20

mattschwarz
Acryldiffusor satiniert
black mat
acrylic diffuser satinised

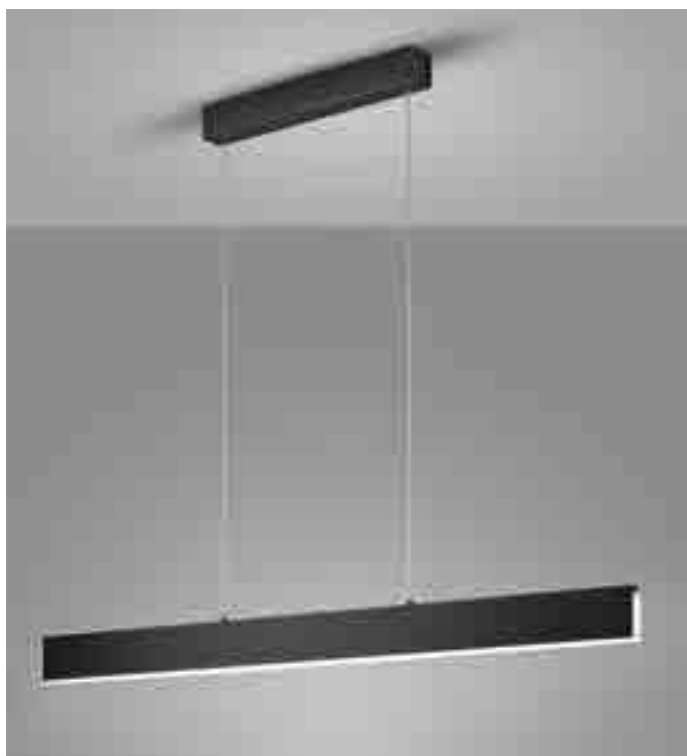

45 W, 2700 K, B 5900 / N 2820 lm, CRI > 90
16/2007.22

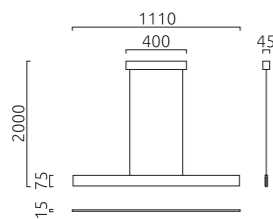



NEX

LED IP20

mattschwarz
Acryldiffusor satiniert
black mat
acrylic diffuser satinised



12 W, 2700 K, B 1620 / N 1150, CRI > 90
18/2007.22

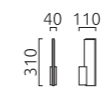



LOOPY

LED    IP20

mattschwarz
Acryldiffusor satiniert
black mat
acrylic diffuser satinised



22 W, 2700 K, B 2370 / N 970 lm, CRI > 90
16/2109.22

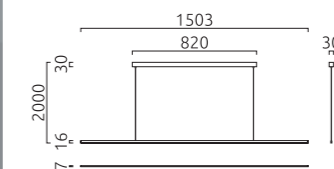

LEXX



mattnickel eloxiert - chrom
Acryldiffusor satiniert
nickel mat anodised - chrome
acrylic diffuser satinised

23 W, 2700 K, B 2630 / N 1820 lm, CRI > 85



16/1504.19

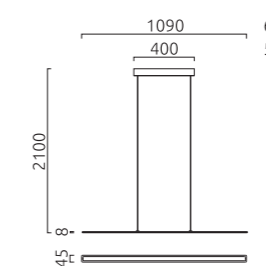

16/1644.19

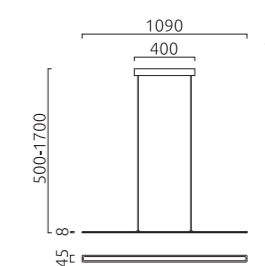

MOYA

LED   IP30



aluminium matt
Acrylglas satiniert
aluminium mat
acrylic glass satinised

29 W, 2800 K, B 3110 / N 1740 lm, CRI > 90
16/1722.26

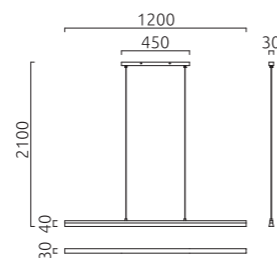



SALLY

LED    IP20



mattnickel - chrom
Glas satiniert
nickel mat - chrome
glass satinised

22 W, 2800 K, B 2460 / N 1890 lm, CRI > 90
26/1641.27/5210

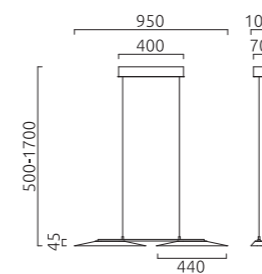

MÖWE

LED    IP20

Acryldiffusor satiniert
acrylic diffuser satinised



22 W, 1800-3000 K (dim-to-warm), B 2140 / N 1690 lm, CRI > 90

mattnickel - chrom / nickel mat - chrome
16/2101.18

mattschwarz / black mat
16/2101.22

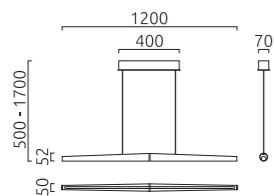

VENTA

LED incl. EASY LIFT IP30

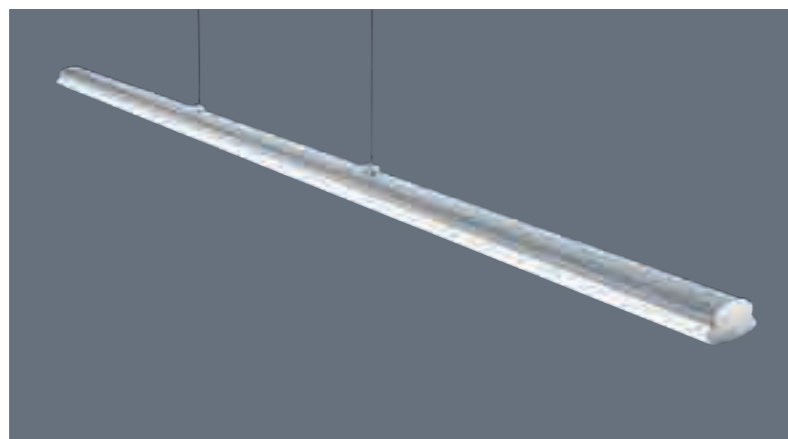

mattnickel - chrom / nickel mat - chrome
16/1645.19
mattschwarz - chrom / black mat - chrome
16/1645.22

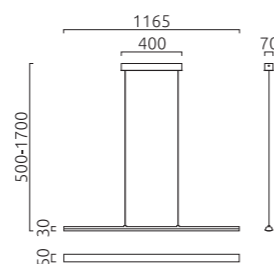

Acryldiffusor satiniert
acrylic diffuser satinised

24 W, 2700 K, B 3340 / N 1910 lm, CRI > 90



VENTA

LED  IP30



Acryldiffusor satiniert
acrylic diffuser satinised

31 W, 2700 K, B 4790 / N 2690 lm, CRI > 90



mattnickel - chrom / nickel mat - chrome
17/1505.19
mattschwarz / black mat
17/1505.22

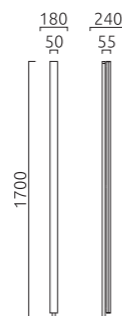



KURVO

LED  IP30

Acryldiffusor satiniert
acrylic diffuser satinised



47 W, 2700 K, B 5390 / N 1620 lm, CRI > 85

mattnickel - chrom / nickel mat - chrome

27/1502.19

mattschwarz - chrom / black mat - chrome

271502.22

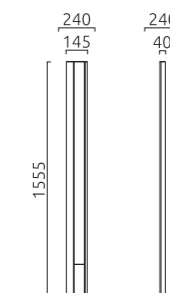

DORO

E27   IP20

Schirm Acryl satiniert
shade acrylic satinised

1 x E27



weiß - chrom / white - chrome
17/1240.84/5045

schwarz - chrom / black - chrome
17/1240.34/5045

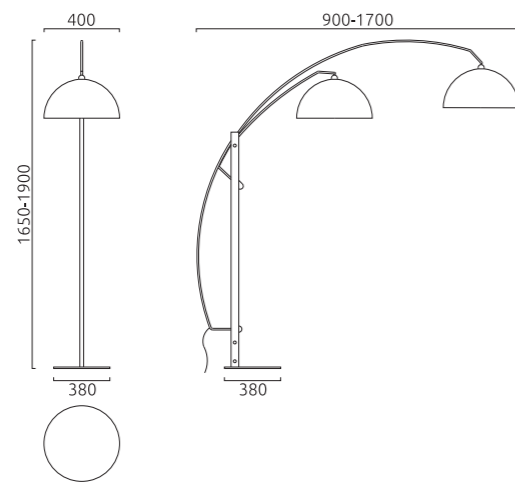

Leuchtmittel nicht im Lieferumfang
bulb not included



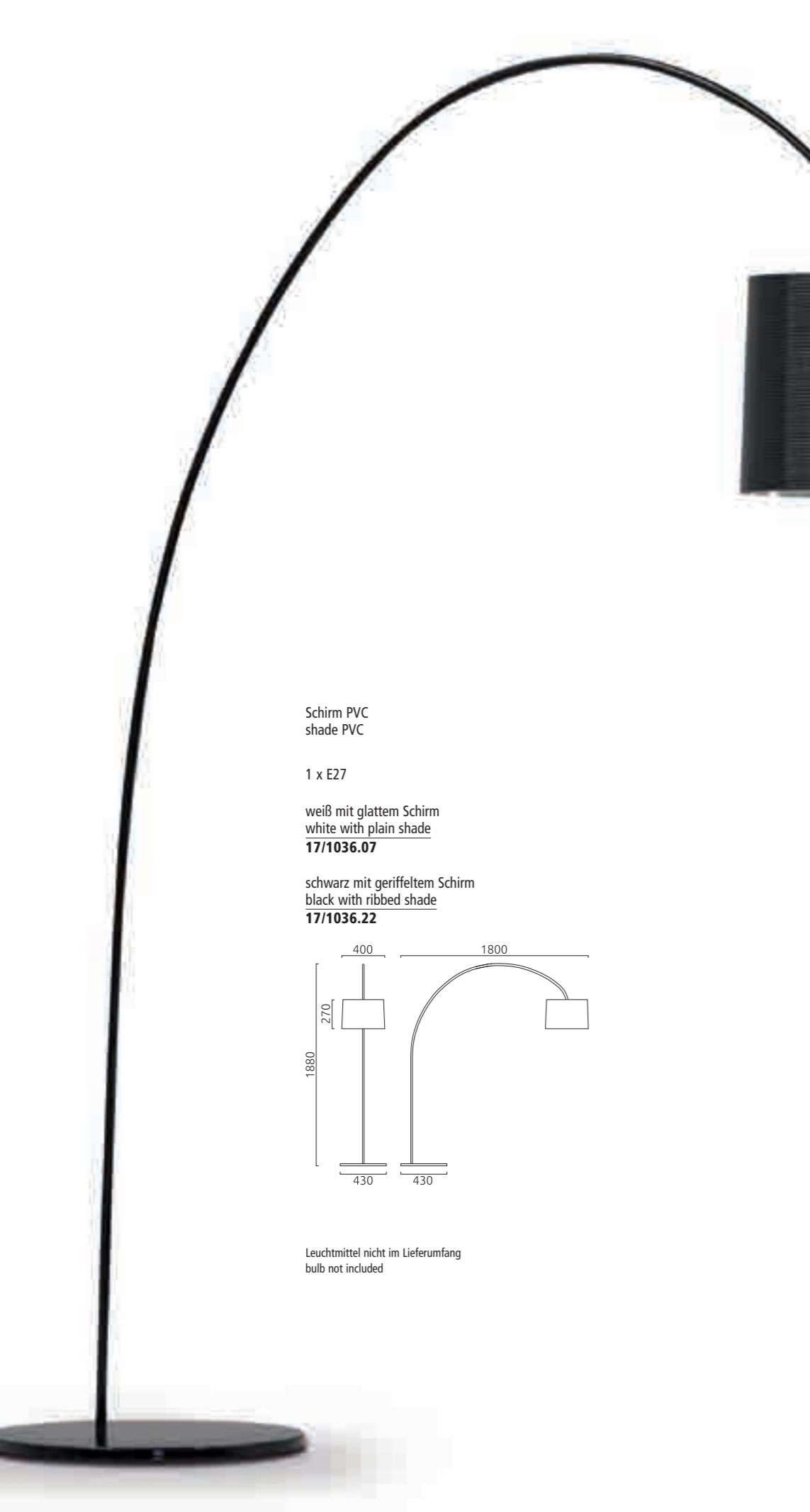

Schirm PVC
shade PVC

1 x E27

weiß mit glattem Schirm
white with plain shade
17/1036.07

schwarz mit geriffeltem Schirm
black with ribbed shade
17/1036.22

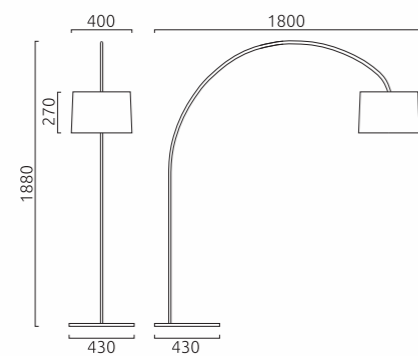

Leuchtmittel nicht im Lieferumfang
bulb not included



ROXX

E27  IP20





PAD

E27  IP20 

mattschwarz
Marmorfuß schwarz
black mat
black marble base

1 x E27

Leuchtmittel nicht im Lieferumfang
bulb not included



Textilschirm weiß / fabric shade white
17/2008.22/9319

Textilschirm schwarz / fabric shade black
17/2008.22/9320

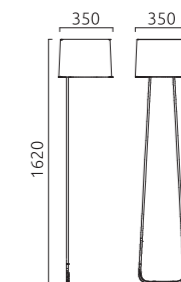



NALA

E27  IP20



mattnickel - chrom
nickel mat - chrome

1 x E27

Schirm Chintz weiß / shade chintz white
17/1845.27/9276

Schirm Chintz anthrazit / shade chintz anthracite
17/1845.27/9283

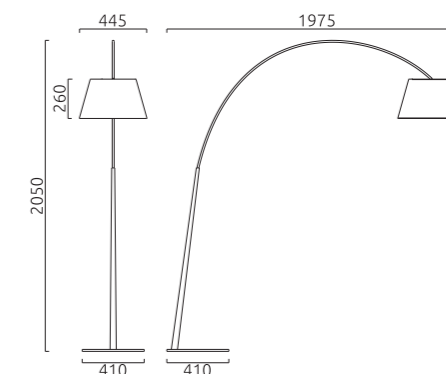

Leuchtmittel nicht im Lieferumfang
bulb not included



CERTO

E27  IP20

mattschwarz - chrom
black mat - chrome

1 x E27



Schirm Chintz weiß / shade chintz white
17/1849.34/9290

Schirm Chintz anthrazit / shade chintz anthracite
17/1849.34/9289

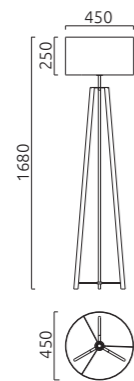

Leuchtmittel nicht im Lieferumfang
bulb not included



CERTO

E27 ↑ IP20

chrom
dreh- und schwenkbar
chrome
rotatable and tiltable

1 x E27



Schirm Chintz weiß / shade chintz white
16/1847.04/9290



Schirm Chintz anthrazit / shade chintz anthracite
16/1847.04/9289



Schirm Chintz mocca / shade chintz mocca
16/1847.04/9288

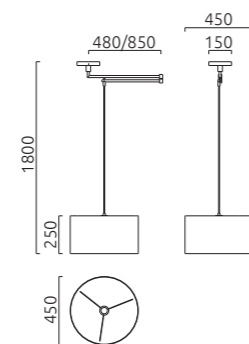

Schirm Chintz weiß / shade chintz white
16/1847.04/9276



Schirm Chintz anthrazit / shade chintz anthracite
16/1847.04/9283

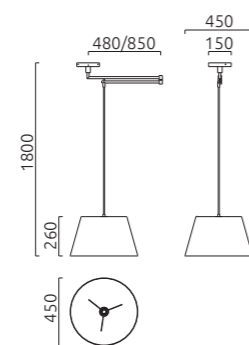

Leuchtmittel nicht im Lieferumfang
bulb not included





CERTO

E27 ↑ IP20

chrom
dreh- und schwenkbar
chrome
rotatable and tiltable

2 x E27



Schirm Chintz weiß / shade chintz white
26/1847.04/9290

Schirm Chintz anthrazit / shade chintz anthracite
26/1847.04/9289

Schirm Chintz mocca / shade chintz mocca
26/1847.04/9288

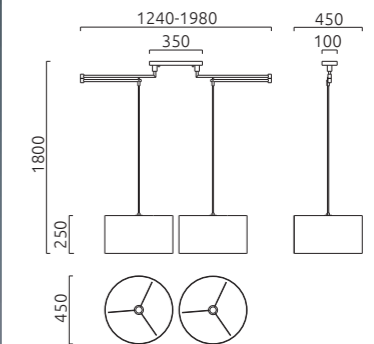

Schirm Chintz weiß / shade chintz white
26/1847.04/9276

Schirm Chintz anthrazit / shade chintz anthracite
26/1847.04/9283

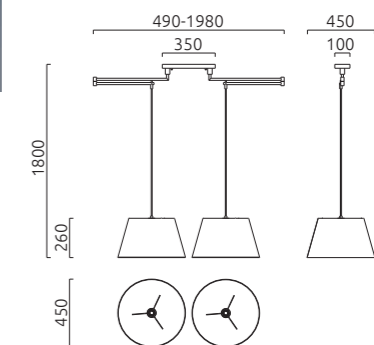

Leuchtmittel nicht im Lieferumfang
bulb not included



LOMO-S

LED   IP20



mattweiß
white mat

88 W, 2800 K, B 10380 / N 5040 lm, CRI > 90

Schirm Chintz weiß / shade chintz white
25/2000.07/9324

Schirm Chintz anthrazit / shade chintz anthracite
25/2000.07/9325

Schirm Chintz mocca / shade chintz mocca
25/2000.07/9326

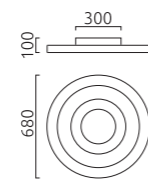

mattnickel
nickel mat



50 W, 2800 K, B 5870 / N 3400 lm, CRI > 90

Schirm Chintz weiß / shade chintz white
16/2000.19/9324

Schirm Chintz anthrazit / shade chintz anthracite
16/2000.19/9325

Schirm Chintz mocca / shade chintz mocca
16/2000.19/9326

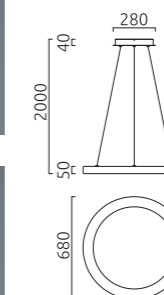

LOMO

LED   IP20

mattweiß
white mat

34 W, 2800 K, B 4030 / N 2500 lm, CRI > 90



Schirm Chintz weiß / shade chintz white
15/1800.07/9277

Schirm Chintz mocca / shade chintz mocca
15/1800.07/9278

Schirm Chintz anthrazit / shade chintz anthracite
15/1800.07/9281

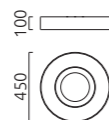

LOMO

LED   IP20

mattweiß
white mat

45 W, 2800 K, B 5220 / N 2840 lm, CRI > 90

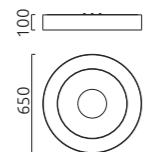

Schirm Chintz weiß
shade chintz white
15/1900.07/9304



Schirm Chintz anthrazit
shade chintz anthracite
15/1900.07/9305



Schirm Chintz mocca
shade chintz mocca
15/1900.07/9306





BORA

LED   IP20

mattnickel eloxiert - chrom
Acryldiffusor satiniert
nickel mat anodised - chrome
acrylic diffuser satinised

31 W, 2800 K, B 3510 / N 2280 lm, CRI > 90



Schirm Chintz weiß / shade chintz white
15/1745.19/9258

Schirm Chintz mocca / shade chintz mocca
15/1745.19/9259

Schirm Chintz anthrazit / shade chintz anthracite
15/1745.19/9292

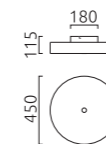

BORA

LED    IP20

mattmessing eloxiert
Acryldiffusor satiniert
brass mat anodised
acrylic diffuser satinised



29 W, 2800 K, B 3280 / N 1930 lm, CRI > 90

Schirm Chintz weiß / shade chintz white
16/1704.02/9256

Schirm Chintz mocca / shade chintz mocca
16/1704.02/9257

Schirm Chintz anthrazit / shade chintz anthracite
16/1704.02/9255

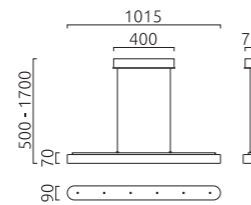

40 W, 2800 K, B 4520 / N 2650 lm, CRI > 90

Schirm Chintz weiß / shade chintz white
16/1904.02/9296

Schirm Chintz mocca / shade chintz mocca
16/1904.02/9297

Schirm Chintz anthrazit / shade chintz anthracite
16/1904.02/9295

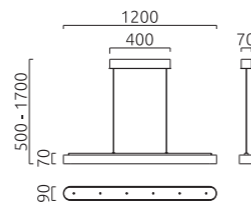



BORA

LED    IP20

mattnickel eloxiert
 Acryldiffusor satiniert
 nickel mat anodised
 acrylic diffuser satinised



29 W, 2800 K, B 3280 / N 1930 lm, CRI > 90
 Schirm Chintz weiß / shade chintz white
16/1704.19/9256
 Schirm Chintz mocca / shade chintz mocca
16/1704.19/9257
 Schirm Chintz anthrazit / shade chintz anthracite
16/1704.19/9255

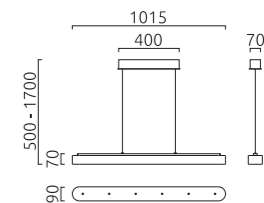

40 W, 2800 K, B 4520 / N 2650 lm, CRI > 90
 Schirm Chintz weiß / shade chintz white
16/1904.19/9296
 Schirm Chintz mocca / shade chintz mocca
16/1904.19/9297
 Schirm Chintz anthrazit / shade chintz anthracite
16/1904.19/9295

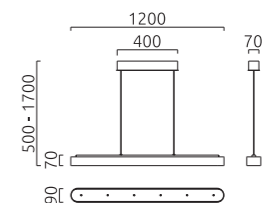



UKA

E27 IP20

mattschwarz
black mat

1 x E27



Textilschirm weiß / fabric shade white
19/2043.22

Textilschirm schwarz / fabric shade black
19/2042.22

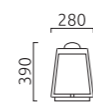

Leuchtmittel nicht im Lieferumfang
bulb not included



Textilschirm weiß / fabric shade white
15/2043.22

Textilschirm schwarz / fabric shade black
15/2042.22

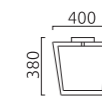



ENNA 2

E14 E27  IP20

blanknickel
Schirm, Chintz weiß
nickel polished
shade, chintz white



1 x E14
19/1138.10

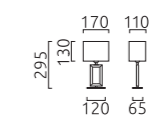

1 x E27
19/1139.10

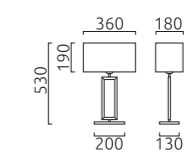

Leuchtmittel nicht im Lieferumfang
bulb not included



TARY

LED  IP20 **YL**
Plus

mattweiß
schwenkbar
inkl. 5-Stufen Touchdimmer
white mat
tiltable
incl. 5-step touch dimmer

13 W, 3000 K, B 1370 / N 640 lm, CRI > 95



19/1970.07

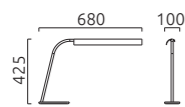





RIX

LED IP20 **YL**
Plus

mattweiß
Acryldiffusor satiniert
white mat
acrylic diffuser satinised



7,5 W, 2700 K, B 760 / N 460 lm, CRI > 90
15/1944.07

190 
110 



10 W, 2700 K, B 1120 / N 670 lm, CRI > 90
inkl. 3-Stufen Touchdimmer /
incl. 3-step touch dimmer
29/1844.07

200 
110 



www.helestra.de/rix



mattweiß / white mat
19/1943.07
mattmessing-schwarz / brass mat-black
19/1943.28

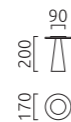

BAX

LED  IP20

Acryldiffusor satiniert
acrylic diffuser satinised

10 W, 2700 K, B 1220 / N 780 lm, CRI > 85



www.helestra.de/bax

TAIL

LED  IP54



13 W, 2700 K, B 1480 / N 530 lm, CRI > 90

mattweiß / white mat

28/2114.07

mattschwarz - gold / black mat - gold

28/2114.28

55 200
210 





SONA

LED   IP20

Acryldiffusor satiniert
acrylic diffuser satinised



24 W, 2900 K, B 2900 / N 2040 lm, CRI > 85

mattschwarz / black mat

15/1993.22

mattweiß / white mat

15/1993.07

blatgold / gold leaf

15/1993.09

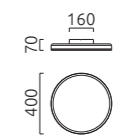

60 W, 2900 K, B 6700 / N 4690 lm, CRI > 85

mattschwarz / black mat

25/1994.22

mattweiß / white mat

25/1994.07

blatgold / gold leaf

25/1994.09

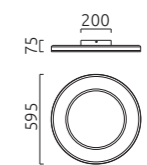



SERVO

LED   IP20 **YL**
Plus

Acryldiffusor satiniert
acrylic diffuser satinised

49 W, 2900 K, B 5780 / N 3840 lm, CRI > 90



mattweiß / white mat
26/1893.07

mattschwarz / black mat
26/1893.22

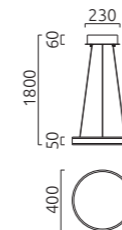



LIV

LED   IP20



mattweiß
Acryldiffusor satiniert
white mat
acrylic diffuser satinised

55 W, 2900 K, B 6480 / N 3910 lm, CRI > 90
26/1892.07

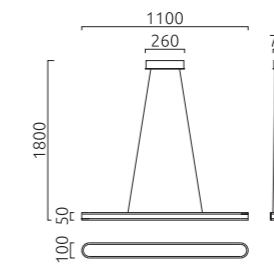



LIV

LED    IP20

Acryldiffusor satiniert
acrylic diffuser satinised



49 W, 2900 K, B 5310 / N 3650 lm, CRI > 90

mattweiß / white mat

26/1692.07

mattschwarz / black mat

26/1692.22

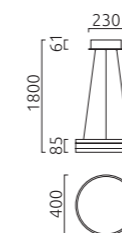

70 W, 2900 K, B 7710 / N 5070 lm, CRI > 90

mattweiß / white mat

26/1792.07

mattschwarz / black mat

26/1792.22

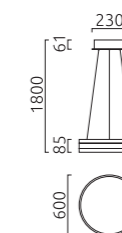

LIV

LED   IP30

Acryldiffusor satiniert
acrylic diffuser satinised



10 W, 2900 K, B 1260 / N 460 lm, CRI > 90

mattweiß / white mat
15/1732.07

mattschwarz / black mat
15/1732.22



17 W, 2900 K, B 2090 / N 740 lm, CRI > 90

mattweiß / white mat
15/1632.07

mattschwarz / black mat
15/1632.22



36 W, 2900 K, B 4630 / N 2340 lm, CRI > 90

mattweiß / white mat
25/1734.07

mattschwarz / black mat
25/1734.22



WES

LED   IP20

mattweiß
Acrylglas satiniert
white mat
acrylic glass satinised



37 W, 3000 K, B 4260 / N 2780 lm, CRI > 90
25/1665.07



29 W, 3000 K, B 3590 / N 2350 lm, CRI > 90
25/1563.07

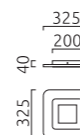

JENNA

LED IP30

mattweiß
Acrylglas satiniert
white mat
acrylic glass satinised



12 W, 3000 K, B 1360 / N 860 lm, CRI > 85
18/1533.07

65
15 170
170 [S] [M] [R]



7 W, 3000 K, B 810 / N 540 lm, CRI > 85
18/1532.07

45
15 180
180 80 [S] [M] [R]



VADA

LED IP40



Acrylglas teilsatiniert
acrylic glass partially satinised

9 W, 2900 K, B 920 / N 620 lm, CRI > 90

mattnickel / nickel mat
15/1728.06

mattweiß / white mat
15/1728.07

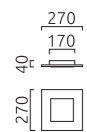

COSI

LED   IP30

mattnickel
Glas satiniert - Kanten poliert
nickel mat
glass satinised - edges polished

22 W, 2900 K, B 2490 / N 1420 lm, CRI > 90



15/2105.06

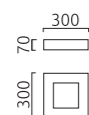



COSI

LED  IP30

mattnickel
 Glas satiniert - Kanten poliert
 nickel mat
 glass satinised - edges polished



7 W, 2900 K, B 1070 / N 610 lm, CRI > 90
15/1905.06



 12 W, 2900 K, B 1780 / N 1020 lm, CRI > 90
15/1906.06

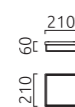

 26 W, 2900 K, B 3220 / N 1840 lm, CRI > 90
15/1907.06



10 W, 2900 K, B 1150 / N 660 lm, CRI > 90
18/2005.06



20 W, 2900 K, B 2660 / N 1520 lm, CRI > 90
18/2006.06





RACK

LED   IP20

Acryldiffusor satiniert
acrylic diffuser satinised

22 W, 2900 K, B 2460 / N 1730 lm, CRI > 90



mattweiß / white mat
15/2254.07

blattgold / gold leaf
15/2254.09

mattschwarz / black mat
15/2254.22

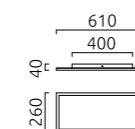

RACK

LED   IP20

Acryldiffusor satiniert
acrylic diffuser satinised

21 W, 2900 K, B 2550 / N 1800 lm, CRI > 90



mattweiß / white mat
15/1954.07

blattgold / gold leaf
15/1954.09

mattschwarz / black mat
15/1954.22

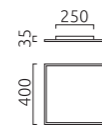

mattweiß / white mat
15/1956.07

blattgold / gold leaf
15/1956.09

mattschwarz / black mat
15/1956.22

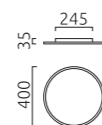



LICA



mattschwarz
Acryldiffusor satiniert
Lichtverteilung direkt / indirekt
Abstrahlwinkel 120°

black mat
acrylic duffuser satinised
light distribution direct / indirect
beam angle 120°



30 W, B 3280 / N 2590/2680/2740 lm, CRI > 90
15/2210.22

50 W, B 5480 / N 4190/4510/4790 lm, CRI > 90
15/2211.22

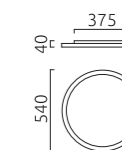

cct 2700 / 3500 / 4000 K
fix einstellbar an der Leuchte oder
variabel über Wandschalter (BS)
constantly adjustable on luminaire or
variable by
wall switch (BS)



TANA

LED IP44

mattschwarz
Glas teilsatiniert
black mat
glass partially satinised



18 W, 2900 K, B 2220 / N 870 lm, CRI > 90
15/1933.22



22 W, 2900 K, B 2640 / N 1050 lm, CRI > 90
15/1934.22





CANIO

E27 IP30



mattweiß
Innenglas opal weiß
white mat
inside glass opal white

1 x E27

Glas klar / glass clear
15/1735.07/5239

Glas grau / glass grey
15/1735.07/5240

Glas amber / glass amber
15/1735.07/5241

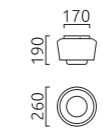

Leuchtmittel nicht im Lieferumfang
bulb not included





SIMO

LED   IP20 

Acrylglas teilsatiniert
acrylic glass partially satinised



25 W, 2700 K, B 2690 / N 1850 lm, CRI > 90

mattweiß / white mat
75/2212.07

mattschwarz / black mat
75/2212.22

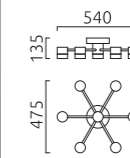

40 W, 2700 K, B 4360 / N 3350 lm, CRI > 90

mattweiß / white mat
115/2212.07

mattschwarz / black mat
115/2212.22

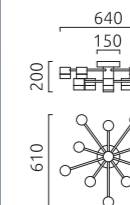

STAY

LED   IP20

30 W, 2800 K, B 3600 / N 2120 lm, CRI > 90



mattweiß / white mat
165/1903.07

aluminium matt / aluminium mat
165/1903.26

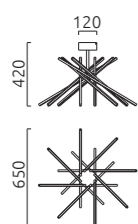



DEX

LED   IP20

aluminium poliert - mattweiß
drehbar
aluminium polished - white mat
rotatable



13 W, 3000 K, B 1480 / N 890 lm, CRI > 90
18/2035.25

270°  80°
70°  4°
80°  4°





COR

LED  IP20

Glas schwarz - klar
Abstrahlwinkel horizontal 136°, vertikal 74°
glass black - clear
beam angle horizontal 136°, vertical 74°

22 W, 2700 K, B 2450 / N 1370 lm, CRI > 90



mattweiß / white mat

18/2116.07

mattschwarz / black mat

18/2116.22

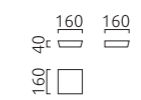

ADEO

LED  IP20



8 W, 2800 K, B 740 / N 490 lm, CRI > 90

mattnickel / nickel mat
18/1807.06

mattweiß / white mat
18/1807.07

75 200 65

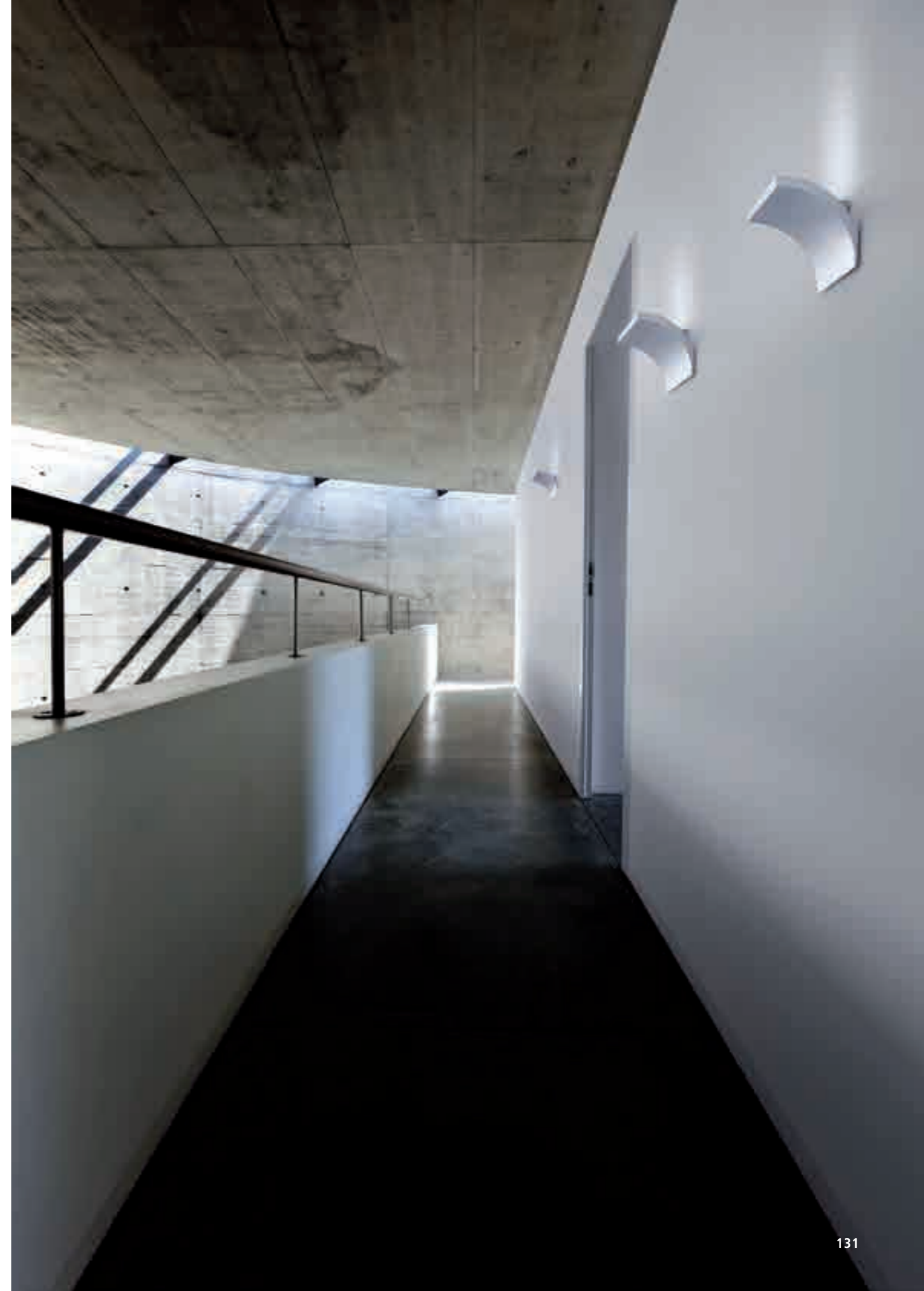

YONA

LED IP20



15 W, 3000 K, B 1650 / N 1310 lm, CRI > 90

18 W, 3000 K, B 1980 / N 1430 lm, CRI > 90

mattweiß / white mat
28/1427.07

aluminium poliert - mattweiß
aluminium polished - white mat
28/1427.25



mattweiß / white mat
38/1427.07

aluminium poliert - mattweiß
aluminium polished - white mat
38/1427.25

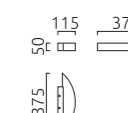



ONNO

LED IP20



6 W, 3000 K, B 730 / N 310 lm, CRI > 90

mattweiß
white mat
18/1225.07

aluminium poliert - mattweiß
aluminium polished - white mat
18/1225.25

70 180 90
□ □ □

12 W, 3000 K, B 1460 / N 620 lm, CRI > 90

mattweiß
white mat
28/1225.07

aluminium poliert - mattweiß
aluminium polished - white mat
28/1225.25

70 90 300
□ □ □



FOSCA

LED IP20



9 W, 3000 K, B 960 / N 580 lm, CRI > 90

mattweiß / white mat

18/1328.07

aluminium matt / aluminium mat

18/1328.26





PONT

LED IP20

6,5 W, 2900 K, B 580 / N 540 lm, CRI > 90



Gips weiß / gypsum white
18/1947.07

60 155
E14 ○





SIRI

G9 IP20

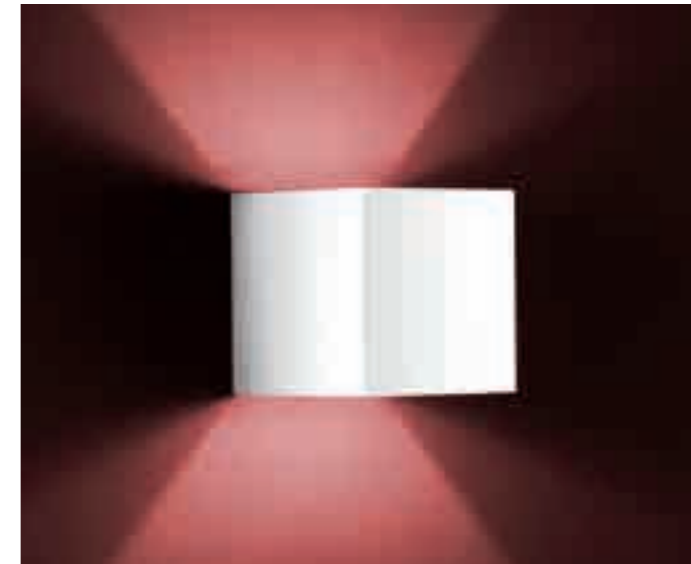

1 x G9

mattweiß
white mat
18/1175.07

aluminium matt
aluminium mat
18/1175.26

100 100
80 □ □

Optionales Zubehör:
Optional Accessories:



Streuscheibe aluminium matt, Glas satiniert
diffuser aluminium mat, glass satinised
5017

Streuscheibe matt weiß, Glas satiniert
diffuser white mat, glass satinised
5056



Metallscheibe aluminium matt (Schlitz)
slotted metal plate aluminium mat
5019

Metallscheibe matt weiß (Schlitz)
slotted metal plate white mat
5057

Leuchtmittel nicht im Lieferumfang
bulb not included





SIRI LED

LED IP30

18 W, 3000 K, B 1860 / N 1340 lm, CRI > 90



mit satinierter Diffusorscheibe /
with satinised diffuser

mattweiß / white mat
15/1558.07

100
□
100
□



ALLY



mattweiß
40° Abstrahlwinkel
white mat
beam angle 40°

16 W, 2700 K, B 1730 / N 1520 lm, CRI > 90



chrom / chrome
15/1960.07-04

weiß / white
15/1960.07-07

schwarz / black
15/1960.07-22

95
100 □
95 ■



DORA

LED IP20

Glas satiniert
glass satinised



7,5 W, 2900 K, B 880 / N 510 lm, CRI > 85

mattweiß / white mat

15/1804.07

mattsilber/ silver mat

15/1804.10

100
85 □
100 ○



7,5 W, 2900 K, B 880 / N 540 lm, CRI > 85

mattweiß / white mat

15/1805.07

mattsilber/ silver mat

15/1805.10

100
85 □
100 □



KARI

LED  IP30

12 W, 2700 K, B 1180 / N 1030 lm, CRI > 90



mattschwarz / black mat

15/1945.22

mattnickel / nickel mat

15/1945.06

mattweiß / white mat

15/1945.07

70

120





KARI

LED  IP30

12 W, 2700 K, B 1180 / N 1030 lm, CRI > 90



mattschwarz / black mat

15/1946.22

mattnickel / nickel mat

15/1946.06

mattweiß / white mat

15/1946.07

115
75 □
115 ○



ENIO



Acryldiffusor satiniert
acrylic diffuser satinised



12 W, 2700 K, B 1310 / N 940 lm, CRI > 90

mattweiß / white mat

	Reflektor / reflector
15/2215.07-07	weiß / white
15/2215.07-09	gold / gold
15/2215.07-22	schwarz / black

mattschwarz / black mat

	Reflektor / reflector
15/2215.22-07	weiß / white
15/2215.22-09	gold / gold
15/2215.22-22	schwarz / black



16 W, 2700 K, B 1670 / N 1390 lm, CRI > 90

mattweiß / white mat

	Reflektor / reflector
15/2216.07-07	weiß / white
15/2216.07-09	gold / gold
15/2216.07-22	schwarz / black

mattschwarz / black mat

	Reflektor / reflector
15/2216.22-07	weiß / white
15/2216.22-09	gold / gold
15/2216.22-22	schwarz / black



PAIR

LED   IP20

Abstrahlwinkel 36°
beam angle 36°

20 W, 2700 K, B 2220 / N 1750 lm, CRI > 90



mattweiß / white mat
15/2027.07

mattschwarz / black mat
15/2027.22



NOG

IP65 **YL**
Plus



GU10-LED max. 6W (Länge/length max. 58 mm)

mattweiß / white mat
15/2129.07

mattschwarz / black mat
15/2129.22

80
85 □
80 ©

Leuchtmittel nicht im Lieferumfang
bulb not included

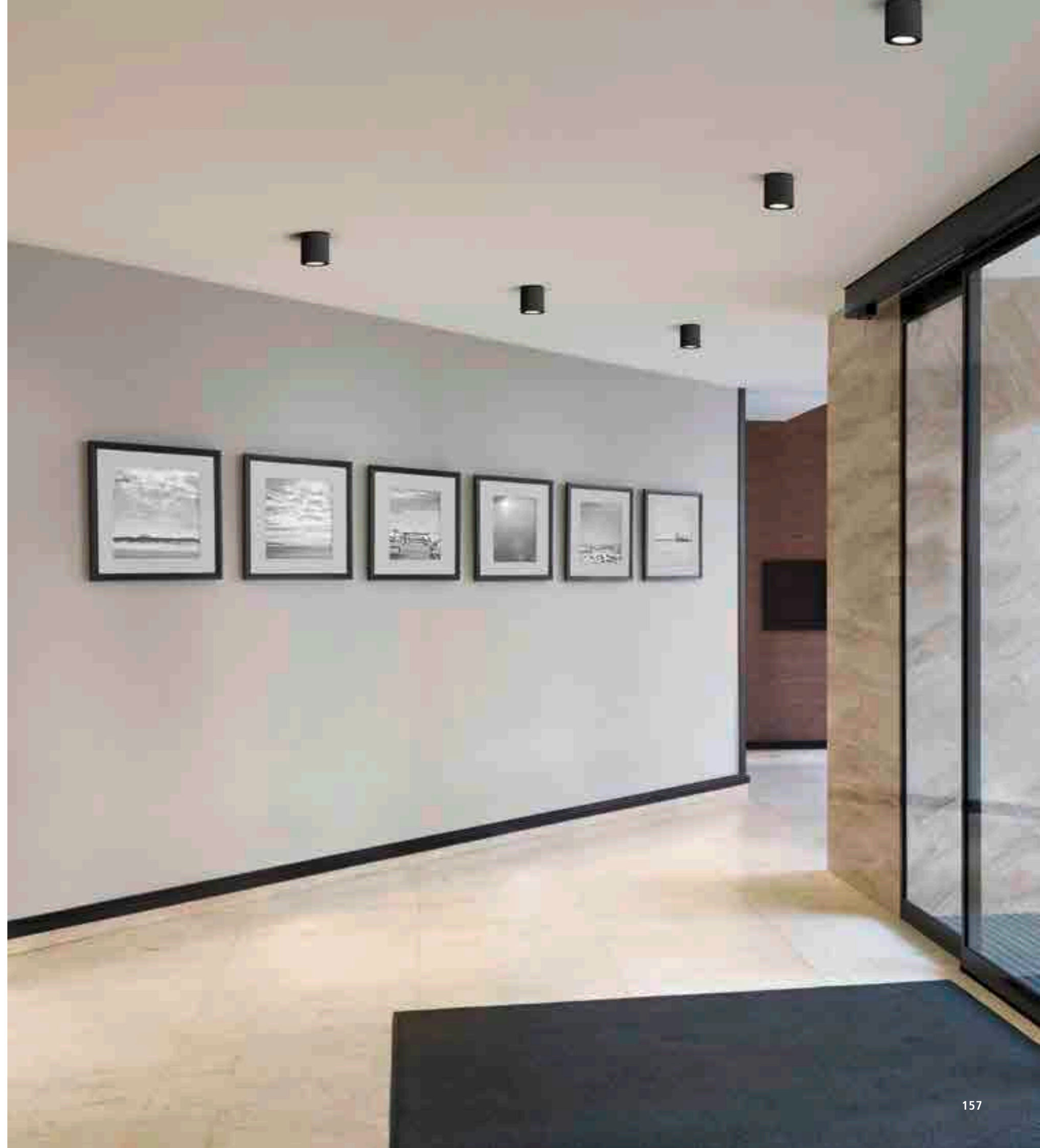



RIWA

LED  IP20

mattweiß
Abstrahlwinkel 30°
dreh- und schwenkbar
white mat
beam angle 30°
rotatable and tiltable



8 W, 2700 K, B 820 / N 480 lm, CRI > 90
15/1806.07

120
20
50  70



 Casambi

24 W, 2700 K, B 2460 / N 1440 lm, CRI > 90
35/1806.07

120
20
65  390



NUT

LED IP20

mattweiß
inkl. wechselbare Reflektoren schwarz, gold, silber
dreh- und schwenkbar
Abstrahlwinkel 24°
white mat
incl. exchangeable reflector black, gold, silver
rotatable and tiltable
beam angle 24°



22 W, 2800 K, B 2320 / N 1640 lm, CRI > 90
25/1915.07



GOTO

LED  IP54

Glaslinse klar
dreh- und kipubar
glass lens clear
rotatable and tiltable

8,5 W, 2700 K, B 780 / N 570 lm, CRI > 90



mattweiß / white mat

15/2013.07

mattschwarz / black mat

15/2013.22

70
120
15
15
15
15





CAS

LED  IP20

Strahler dreh- und kippbar
 Abstrahlwinkel 36°
 spotlights rotatable and tiltable
 beam angle 36°



4,5 W, 2700 K, B 520 / N 410 lm, CRI > 95
 mattweiß / white mat
15/2115.07
 mattschwarz / black mat
15/2115.22

130



10 W, 2700 K, B 1040 / N 820 lm, CRI > 95
 mattweiß / white mat
25/2115.07
 mattschwarz / black mat
25/2115.22

180



PAX

LED  IP20

mattweiß
Glas klar
dreh- und schwenkbar
Abstrahlwinkel 12°
white mat
glass clear
rotatable and tiltable
beam angle 12°



230 V - 7,5 W, 2900 K, B 780 / N 560 lm, CRI > 90
15/1808.07

70° 
80° 



230 V - 15 W, 2900 K, B 1560 / N 1120 lm, CRI > 90
25/1808.07

180° 
70° 
80° 



PONT

LED   IP20

Glaslinse klar mit herausnehmbarer matter Filterscheibe
 dreh-(355°) und kippar (80°)
 Abstrahlwinkel verstellbar 15°-45°
 glass lens clear with removable mat diffuser
 rotatable (355°) and tiltable (80°)
 beam angle adjustable 15°-45°



9,5 W, 2700 K, B 980 / N 590 lm, CRI > 90

mattweiß / white mat

15/2080.07

mattschwarz / black mat

15/2080.22

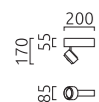

19 W, 2700 K, B 1960 / N 1140 lm, CRI > 90

mattweiß / white mat

25/2080.07

mattschwarz / black mat

25/2080.22

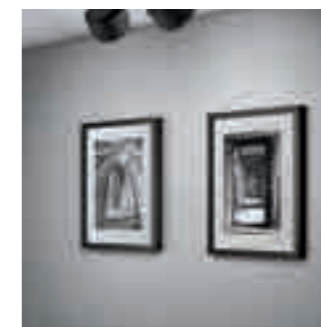
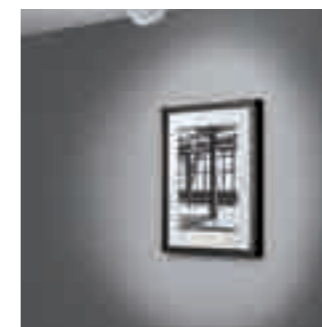
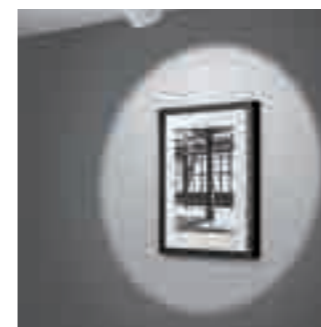
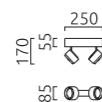



ROTA

LED  IP20  **YL**
Plus

dreh- und schwenkbar
rotatable and tiltable



15 W, 2800 K, B 1580 / N 1170 lm, CRI > 95, 40°

mattweiß / white mat
15/1964.07

mattschwarz / black mat
15/1964.22

100 
105 
100 



9 W, 2800 K, B 890 / N 620 lm, CRI > 95, 36°

mattweiß / white mat
15/2164.07

mattschwarz / black mat
15/2164.22



80 
85 
80 



30 W, 2800 K, B 3160 / N 2340 lm, CRI > 95, 40°

mattweiß / white mat
25/1964.07

mattschwarz / black mat
25/1964.22

205 
105 
100 



ROTA

LED  IP20  YL Plus

40° Abstrahlwinkel
beam angle 40°

11 W, 2800 K, B 1080 / N 690 lm, CRI > 95, 40°



mattweiß / white mat
15/1965.07

mattschwarz / black mat
15/1965.22

105   



PIC

LED IP20

Einbaurahmen mattweiß
Abstrahlwinkel 50°
recessed frame white mat
beam angle 50°



Quadratisch / square

	Reflektor / reflector	
15/2050.07-07/27	weiß / white	10 W, 2700 K, B 1030 / N 460 lm, CRI > 90
15/2050.07-22/27	schwarz / black	10 W, 2700 K, B 1030 / N 460 lm, CRI > 90
15/2050.07-07/30	weiß / white	10 W, 3000 K, B 1030 / N 480 lm, CRI > 90
15/2050.07-22/30	schwarz / black	10 W, 3000 K, B 1030 / N 480 lm, CRI > 90
15/2050.07-07/40	weiß / white	10 W, 4000 K, B 1030 / N 550 lm, CRI > 90
15/2050.07-22/40	schwarz / black	10 W, 4000 K, B 1030 / N 550 lm, CRI > 90

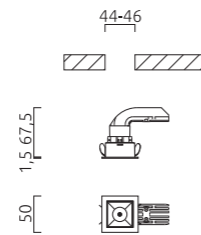

Rund / round

	Reflektor / reflector	
15/2060.07-07/27	weiß / white	10 W, 2700 K, B 1030 / N 460 lm, CRI > 90
15/2060.07-22/27	schwarz / black	10 W, 2700 K, B 1030 / N 460 lm, CRI > 90
15/2060.07-07/30	weiß / white	10 W, 3000 K, B 1030 / N 480 lm, CRI > 90
15/2060.07-22/30	schwarz / black	10 W, 3000 K, B 1030 / N 480 lm, CRI > 90
15/2060.07-07/40	weiß / white	10 W, 4000 K, B 1030 / N 550 lm, CRI > 90
15/2060.07-22/40	schwarz / black	10 W, 4000 K, B 1030 / N 550 lm, CRI > 90
15/2061.07/27	Acryl / acrylic	10 W, 2700 K, B 1030 / N 450 lm, CRI > 90
15/2061.07/30	Acryl / acrylic	10 W, 3000 K, B 1030 / N 460 lm, CRI > 90
15/2061.07/40	Acryl / acrylic	10 W, 4000 K, B 1030 / N 500 lm, CRI > 90

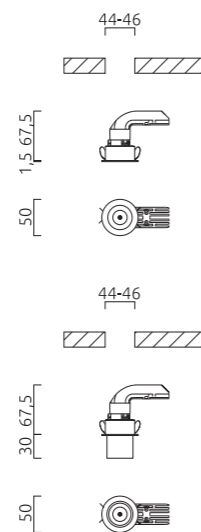

LED-Konverter bitte separat bestellen /
please order LED driver separately

9 W
6050



10 W
6051





SKA

LED   IP20

Glas teilsatiniert
glass partially satinised

10 W, 2700 K, B 1060 / N 510 lm, CRI > 90



15/2012.00

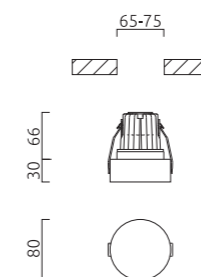

LUG

LED   IP20

mattweiß
Glaslinse klar
white mat
glass lens clear



9 W, 2700 K, B 960 / N 600 lm, CRI > 90
15/2014.07

16 W, 2700 K, B 1640 / N 1020 lm, CRI > 90
15/2015.07

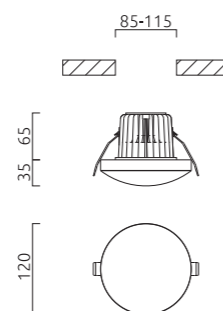
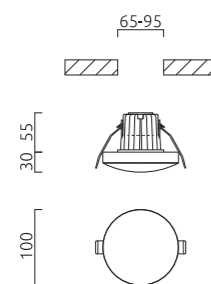

ONTO

LED IP20

Einbauleuchte
drehbar
recessed luminaire
rotatable

4 W, 2900 K, B 420 / N 310 lm, CRI > 90
indirekt / uplight

62,15 80



mattweiß / white mat
15/1938.07



aluminium matt / aluminium mat
15/1938.26



Einbau in Unterputz- oder
Hohlwandboxen möglich
mount in flushmounted or
cavity wall box



SENT

LED IP54







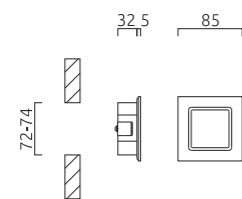





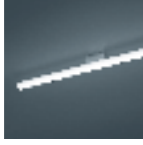









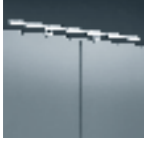
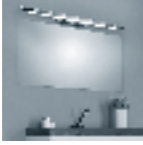



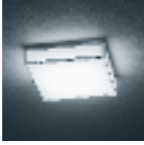





mattweiß
Einbauleuchte
Lichtaustritt verstellbar
white mat
recessed mounted
light beam adjustable

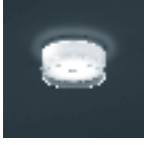

3 W, 3000 K, B 350 / N 170 lm, CRI > 90
18/2016.07





ONTA 188-189	LOOM 190-193	SLATE 194-197	VIS 198-199	THEIA 200-203	NOK 204-205	LADO 206-207	PONTO 208-209
	 	 		 		 	
GAIA 210-213	ARGO 214-215	COSI 216-221	ZELO 222-225	KYMO 226-227	KETO 228-229	LIS 230-231	OLVI 232-233
 		  	 	 	 	 	
YUMA 234-235	TANA 236-237	PALA 238-239	OSO 240-243	IVA 244-245	SID 246-247		
	 		  				

INDEX

ARGO	214-215
COSI	216-221
GAIA	210-213
IVA	244-245
KETO	228-229
KYMO	226-227
LADO	206-207
LIS	230-231
LOOM	190-193
NOK	204-205
OLVI	232-233
ONTA	188-189
OSO	240-243
PALA	238-239
PONTO	208-209
SID	246-247
SLATE	194-197
TANA	236-237
THEIA	200-203
VIS	198-199
YUMA	234-235
ZELO	222-225





ONTA

LED IP44

chrom
Acrylglas satiniert
nur zur Spiegelmontage
chrome
acrylic glass satinised
mirror mounted only



13 W, 2900 K, B 1290 / N 950 lm, CRI > 90
18/2120.04

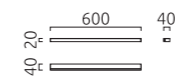

18 W, 2900 K, B 1890 / N 1430 lm, CRI > 90
18/2121.04

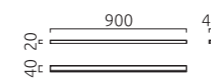

24 W, 2900 K, B 2540 / N 1850 lm, CRI > 90
18/2122.04

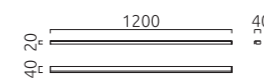

LOOM

LED IP44

chrom
Acrylglas satiniert
chrome
acrylic glass satinised



5,5 W, 2900 K, B 625 / N 500 lm, CRI > 90
18/2020.04



12 W, 2900 K, B 1500 / N 1130 lm, CRI > 90
18/2021.04



18 W, 2900 K, B 2250 / N 1710 lm, CRI > 90
18/2022.04

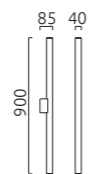

20 W, 2900 K, B 2750 / N 1990 lm, CRI > 90
18/2023.04

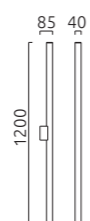



LOOM

LED IP44

mattschwarz
Acrylglas satiniert
black mat
acrylic glass satinised



5,5 W, 2900 K, B 625 / N 500 lm, CRI > 90
18/2020.22



12 W, 2900 K, B 1500 / N 1130 lm, CRI > 90
18/2021.22



18 W, 2900 K, B 2250 / N 1710 lm, CRI > 90
18/2022.22

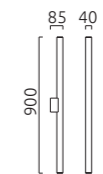

20 W, 2900 K, B 2750 / N 1990 lm, CRI > 90
18/2023.22

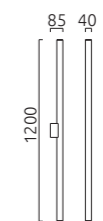

SLATE

LED IP44

mattschwarz
Acrylglas satiniert
black mat
acrylic glass satinised



6,5 W, 2900 K, B 710 / N 360 lm, CRI > 90
18/2037.22



15 W, 2900 K, B 1570 / N 960 lm, CRI > 90
18/2038.22



20 W, 2900 K, B 2130 / N 1260 lm, CRI > 90
18/2039.22

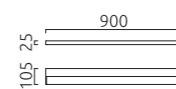

29 W, 2900 K, B 3120 / N 1740 lm, CRI > 90
18/2040.22

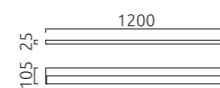



SLATE

LED IP44

chrom
Acrylglas satiniert
chrome
acrylic glass satinised



6,5 W, 2900 K, B 710 / N 360 lm, CRI > 90
18/2037.04



15 W, 2900 K, B 1570 / N 960 lm, CRI > 90
18/2038.04

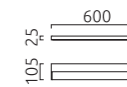

20 W, 2900 K, B 2130 / N 1260 lm, CRI > 90
18/2039.04

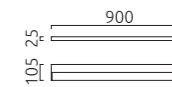

29 W, 2900 K, B 3120 / N 1740 lm, CRI > 90
18/2040.04

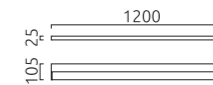

VIS

LED IP44

chrom
Acrylglas satiniert
chrome
acrylic glass satinised



23 W, 2900 K, B 2490 / N 1540 lm, CRI > 90
18/2024.04

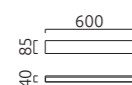

34 W, 2900 K, B 3680 / N 2260 lm, CRI > 90
18/2025.04

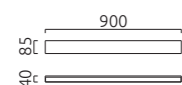

46 W, 2900 K, B 5040 / N 3090 lm, CRI > 90
18/2026.04

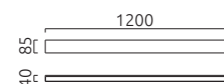

inkl. Zubehör für Wand- oder Spiegelmontage
incl. fixing for wall or mirror mounting



THEIA

LED IP44

mattschwarz
Glas satiniert
Acrylglas satiniert
black matt
glass satinised
acrylic glass satinised



13 W, 2900 K, B 1380 / N 495 lm, CRI > 90
18/1825.22



19 W, 2900 K, B 2110 / N 980 lm, CRI > 90
18/1826.22

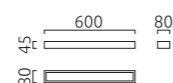

25 W, 2900 K, B 2820 / N 1410 lm, CRI > 90
18/1827.22

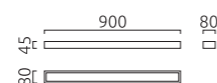

31 W, 2900 K, B 3540 / N 1800 lm, CRI > 90
18/1828.22

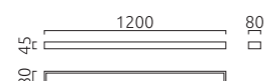



THEIA

LED IP44

chrom
 Glas satiniert
 Acrylglas satiniert
 chrome
 glass satinised
 acrylic glass satinised

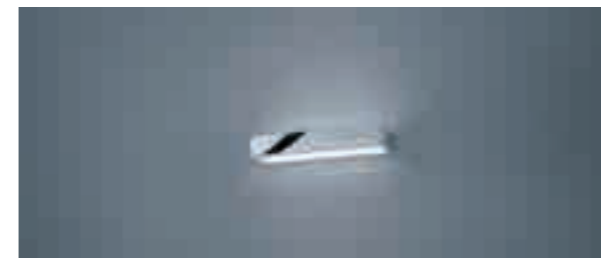

13 W, 2900 K, B 1380 / N 495 lm, CRI > 90
18/1825.04

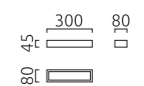

19 W, 2900 K, B 2110 / N 980 lm, CRI > 90
18/1826.04

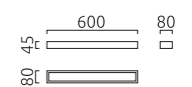

25 W, 2900 K, B 2820 / N 1410 lm, CRI > 90
18/1827.04

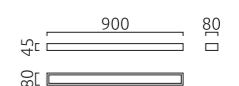

31 W, 2900 K, B 3540 / N 1800 lm, CRI > 90
18/1828.04

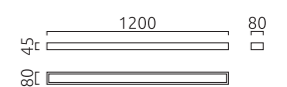



NOK

LED IP44

chrom
Acrylglas satiniert
chrome
acrylic glass satinised

inkl. Zubehör für Wand- oder Spiegelmontage
incl. fixing for wall or mirror mounting



16 W, 2900 K, B 1730 / N 1250 lm, CRI > 90
18/2031.04

600 60
⊗ □



25 W, 2900 K, B 2720 / N 2050 lm, CRI > 90
18/2032.04

900 60
⊗ □



32 W, 2900 K, B 3460 / N 2590 lm, CRI > 90
18/2033.04

1200 60
⊗ □



LADO

LED IP44

Acrylglas satiniert
acrylic glass satinised



12 W, 2900 K, B 1260 / N 1040 lm,
CRI > 90

chrom / chrome
18/1812.04

mattschwarz / black mat
18/1812.22

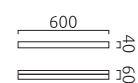

18 W, 2900 K, B 1890 / N 1560 lm,
CRI > 90

chrom / chrome
18/1813.04

mattschwarz / black mat
18/1813.22

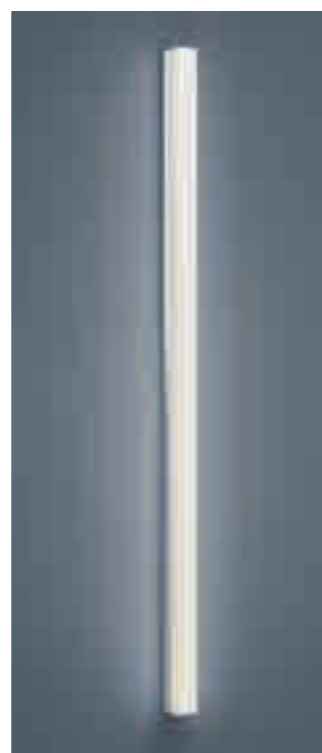
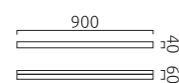

24 W, 2900 K, B 2520 / N 2080 lm,
CRI > 90

chrom / chrome
18/1814.04

mattschwarz / black mat
18/1814.22

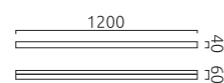

inkl. Zubehör für Wand-
oder Spiegelmontage
incl. fixing for wall or mirror
mounting



www.helestra.de/lado

207

PONTO

LED IP44

chrom
Acrylglas satiniert
chrome
acrylic glass satinised



12 W, 2900 K, B 1280 / N 980 lm, CRI > 90
18/1833.04

70
D 600



18 W, 2900 K, B 1920 / N 1460 lm, CRI > 90
18/1834.04

70
D 900



24 W, 2900 K, B 2560 / N 1940 lm, CRI > 90
18/1835.04

70
D 1200





GAIA

LED IP44



chrom
Acrylglas satiniert
inkl. LED-Konverter extern (130x52x13 mm)
Tuneable white 2700 K - 6000 K
chrome
acrylic glass satinised
incl. LED-converter external (130x52x13 mm)
Tuneable white 2700 K - 6000 K



12 W, 2700-6000 K, B 1080 / N 650 lm, CRI > 90
18/1815.04

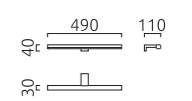

16 W, 2700-6000 K, B 1520 / N 830 lm, CRI > 90
18/1816.04

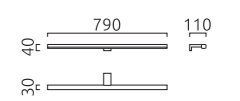

18 W, 2700-6000 K, B 1760 / N 1070 lm, CRI > 90
18/1817.04

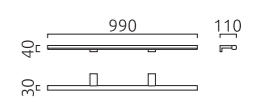

inkl. Zubehör für Wand-, Spiegel- oder Möbelmontage
incl. fixing for wall, mirror or surface mounting



GAIA

LED    IP44

chrom
Acrylglas satiniert
inkl. LED-Konverter extern (130x52x13 mm)
Tuneable white 2700 K - 6000 K

chrome
acrylic glass satinised
incl. LED-converter external (130x52x13 mm)
Tuneable white 2700 K - 6000 K

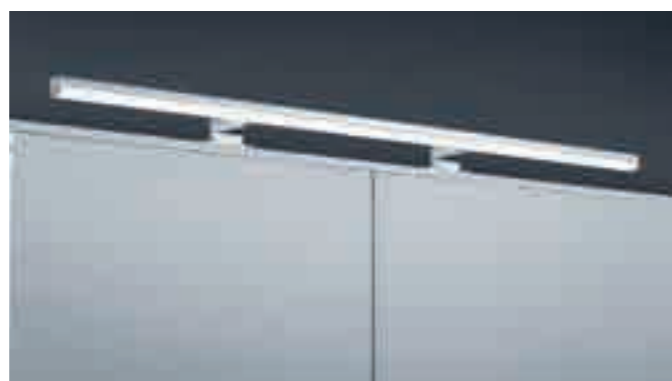

12 W, 2700-6000 K, B 1080 / N 650 lm, CRI > 90
18/1815.04

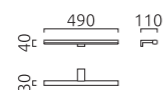

16 W, 2700-6000 K, B 1520 / N 830 lm, CRI > 90
18/1816.04

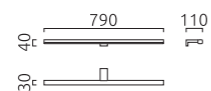

18 W, 2700-6000 K, B 1760 / N 1070 lm, CRI > 90
18/1817.04

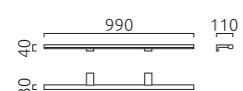

inkl. Zubehör für Wand-, Spiegel- oder Möbelmontage
incl. fixing for wall, mirror or surface mounting





ARGO

LED IP44

chrom
Acrylglas satiniert
chrome
acrylic glass satinised



10 W, 2900 K, B 980 / N 660 lm, CRI > 90
18/1935.04

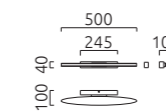

12 W, 2900 K, B 1270 / N 850 lm, CRI > 90
18/1936.04

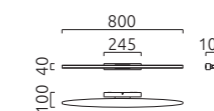

COSI

LED  IP30

Glas satiniert - Kanten poliert
glass satinised - edges polished



7 W, 2900 K, B 1070 / N 610 lm, CRI > 90

chrom / chrome
15/1905.04

mattnickel / nickel mat
15/1905.06



12 W, 2900 K, B 1780 / N 1020 lm, CRI > 90

chrom / chrome
15/1906.04

mattnickel / nickel mat
15/1906.06

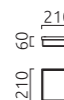

26 W, 2900 K, B 3220 / N 1840 lm, CRI > 90

chrom / chrome
15/1907.04

mattnickel / nickel mat
15/1907.06





COSI

LED  IP30

Glas satiniert - Kanten poliert
 glass satinised - edges polished



10 W, 2900 K, B 1150 / N 660 lm,
 CRI > 90

chrom / chrome
18/2005.04

mattnickel / nickel mat
18/2005.06

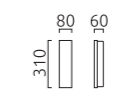

20 W, 2900 K, B 2660 / N1520 lm,
 CRI > 90

chrom / chrome
18/2006.04

mattnickel / nickel mat
18/2006.06

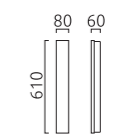

COSI

LED   IP30

Glas satiniert - Kanten poliert
glass satinised - edges polished

22 W, 2900 K, B 2490 / N 1420 lm, CRI > 90



mattnickel / nickel mat
15/2105.06

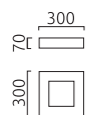

chrom / chrome
15/2105.04





ZELO

LED IP44

chrom
Acrylglas satiniert
chrome
acrylic glass satinised



12 W, 2900 K, B 1320 / N 820 lm, CRI > 90
15/1950.04



19 W, 2900 K, B 2180 / N 1310 lm, CRI > 90
15/1951.04

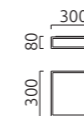



ZELO

LED IP44

chrom
Opalglas satiniert
chrome
opal glass satinised



12 W, 2900 K, B 1460 / N 940 lm, CRI > 90
15/1820.04



18 W, 2900 K, B 2210 / N 1420 lm, CRI > 90
15/1821.04



KYMO

LED IP44

chrom
Glas opal weiß
chrome
glass opal white



12 W, 2900 K, B 1360 / N 940 lm, CRI > 90
15/2124.04

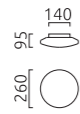

21 W, 2900 K, B 2040 / N 1420 lm, CRI > 90
15/2125.04

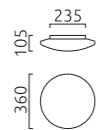



KETO

LED IP44

Opalglas satiniert
opal glass satinised

6 W, 2900 K, B 630 / N 410 lm, CRI > 90



chrom / chrome
15/1822.04

100
125
100



chrom / chrome
15/1823.04

100
125
100



mattschwarz / black mat
15/1822.22

100
125
100



mattschwarz / black mat
15/1823.22

100
125
100



LIS

LED IP44

chrom
Opalglas satiniert
chrome
glass opal satinised



3,5 W, 2900 K, B 490 / N 340 lm, CRI > 90
18/2123.04

145 140 120
○ ○ ○



12 W, 2900 K, B 1680 / N 1010 lm, CRI > 90
48/2029.04

120 600
○ ○ ○ ○ ○ ○ ○ ○ ○ ○

18 W, 2900 K, B 2520 / N 1490 lm, CRI > 90
68/2029.04

120 900
○ ○ ○ ○ ○ ○ ○ ○ ○ ○



OLVI

LED IP44

chrom
Innenglas Opal weiß
Aussenglas klar
chrome
Internal glass opal white
external glass clear



12 W, 2900 K, B 1320 / N 840 lm, CRI > 90
15/1930.04



12 W, 2900 K, B 1320 / N 1020 lm, CRI > 90
15/1931.04



YUMA

LED IP30

Opalglas mit klarem Dekorrand
opal glass with clear decorative edge



12 W, 2700 K, B 1260 / N 820 lm, CRI > 90
18/1442.08/5152



23 W, 2700 K, B 2740 / N 2150 lm, CRI > 90
15/1441.08/5149



36 W, 2700 K, B 4140 / N 3240 lm, CRI > 90
15/1440.08/5146

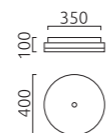

TANA

LED IP44

Glas teilsatiniert
glass partially satinised



18 W, 2900 K, B 2220 / N 870 lm, CRI > 90

chrom / chrome

15/1933.04

mattschwarz / black mat

15/1933.22



22 W, 2900 K, B 2640 / N 1050 lm, CRI > 90

chrom / chrome

15/1934.04

mattschwarz / black mat

15/1934.22





PALA

LED  IP30

Acryldiffusor satiniert
acrylic diffuser satinised

9 W, 2900 K, B 900 / N 725 lm, CRI > 90



mattweiß / white mat
15/1629.07

aluminium matt / aluminium mat
15/1629.26

100
R □
Ø O



OSO

LED  IP44

Abstrahlwinkel 40°
beam angle 40°

7,5 W, 2700 K, B 710 / N 370 lm, CRI > 90



Glas klar-schwarz / glass clear-black
mattschwarz / black mat
15/1553.22

65
55
□
●



Glas klar - opal / glass clear - opal
mattweiß / white mat
15/1553.07
aluminium matt / aluminium mat
15/1553.26



Glas klar - opal / glass clear - opal
mattweiß / white mat
15/1552.07
aluminium matt / aluminium mat
15/1552.26



Glas klar-schwarz / glass clear-black
mattschwarz / black mat
15/1552.22

65
55
□
●





OSO

LED  IP54

mattweiß
 Glas teilsatiniert
 Abstrahlwinkel 30°
 white mat
 glass partially satinised
 beam angle 30°

8 W, 2900 K, B 780 / N 570 lm, CRI > 90



15/2018.07

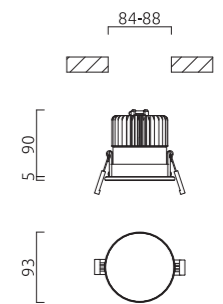

15/2019.07

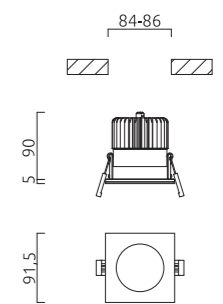

IVA

LED   IP44

Acryling satiniert
acrylic ring satinised

5 W, 2900 K, B 560 / N 480 lm, CRI > 90



15/2041.00

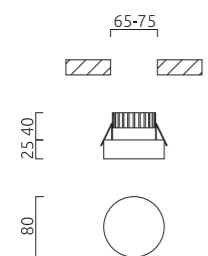

SID



schwenkbar 20°
Abstrahlwinkel 60°
tiltable 20°
beam angle 60°

11 W, 3000 K, B 1150 / N 890 lm, CRI > 90



chrom / chrome
15/2034.04



mattweiß / white mat
15/2034.07



mattschwarz / black mat
15/2034.22

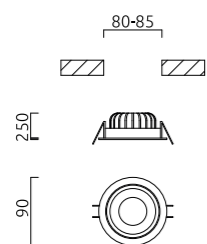



add-it

Das modulare Schienensystem
mit unzähligen Möglichkeiten.

The modular track system with
countless possibilities.

Add-it Schienensystem

Mit unserem neu entwickelten modularen Schienensystem bringen wir Licht ins Dunkel! Dekorativ – innovativ – intuitiv! Dekoratives Licht lässt sich mit dem Add-it System individuell an fast jede Situation anpassen. Eine große Auswahl an Strahlern, Pendelleuchten und Lichtelementen, sowie vielfältige Konfigurationsmöglichkeiten machen es möglich. Innovative Technik ermöglicht die einfache Installation als reines Aufbausystem (Treiber in der Schiene integriert) und die Dimmung über Funk. Auch eine App-Steuerung ist möglich.

Add-it track system

With our newly developed modular track system, we bring light into the dark! Decorative – innovative – intuitive! Decorative light is easy to adapt to almost any situation with the Add-it system. A great choice of spots, pendant luminaires and light elements as well as numerous configuration options make it possible. Innovative technology allows for surface-only installation (driver integrated in the track) and wireless dimming, dramatically simplifying the installation. Optional app control is also available.

Bei der Planung hilft Ihnen auch unser Konfigurator auf unserer Website:

Our configurator on our website will also help you with planning:

www.helestra.de/add-it



ADD-IT

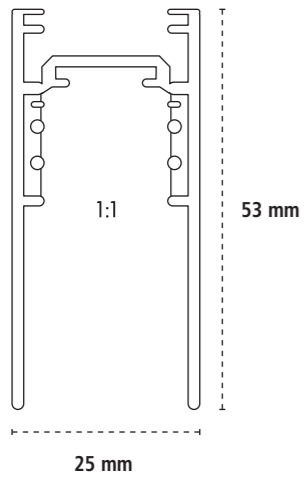

Lichtelemente
light elements



ADD-IT

Technische Daten / Technical specifications

Querschnitt / Profile

Obere Länge / Upper length (A)

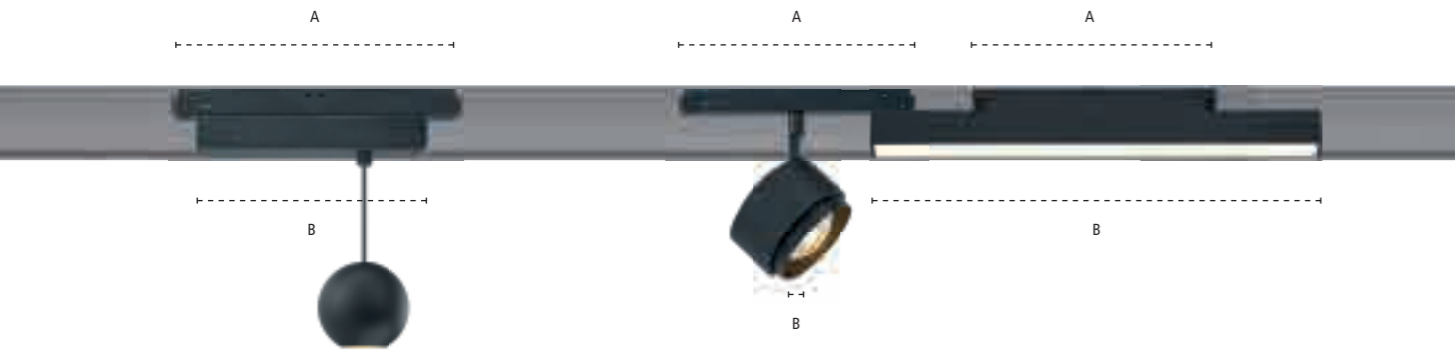

Untere Länge / Bottom length (B)



Magnetschienen-System, Profil 25 x 53 mm / 24 V
Magnetic track system, profile 25 x 53 mm / 24 V

			A	B
6600	Schiene 750 mm / Track 750 mm	mattschwarz / matt black	750 mm	750 mm
6601	Schiene 1150 mm / Track 1150 mm	mattschwarz / matt black	1150 mm	1150 mm
6602	Schiene 1650 mm / Track 1650 mm	mattschwarz / matt black	1650 mm	1650 mm
	inkl. Endkappen, 2-er Pack / including end caps, 2 pack	mattschwarz / matt black		
6608	Abdeckung für Schiene / Cover for track	mattschwarz / matt black		1000 mm



80 0,5
0 8

6606	Abdeckung für Deckendosen / Cover for ceiling outlet	mattweiß / matt white	80 x 80 mm
6607	Abdeckung für Deckendosen / Cover for ceiling outlet	mattschwarz / matt black	80 x 80 mm





ADD-IT

Technische Daten / Technical specifications



			A	B
6604	Linienverbinder / Line connector	mattschwarz / matt black	270 mm	0 mm
6603	90°-Verbinder / 90° connector	mattschwarz / matt black	185/185 mm	0/0 mm
	inkl. elektr. Verbinder / incl. electrical connector			



			A	B
6620	Konverter 60 W int / Converter 60 W int	systemintegriert / system-integrated	300 mm	300 mm
	inkl. Abdeckung / including cover			



			A	B
6622	Konverter 60 W ext / Converter 60 W ext	für externe Einspeisung / for external feed	150 mm	0 mm
6623	Konverter 100 W ext / Converter 100 W ext	für externe Einspeisung / for external feed	150 mm	0 mm

 Smart-Home Einbindung möglich. Alle Informationen dazu unter www.helestra.de/add-it
 Smart-home integration is available. All information at www.helestra.de/add-it

6605	Fernbedienung / remote control	schwarz / black
Dimmung nur über Fernbedienung möglich / Dimming only possible via remote control		



mit Memoryfunktion
with memory function



ADD-IT

Alle Leuchten / All luminaires:

2700 K, CRI > 90

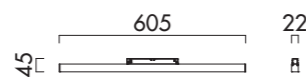
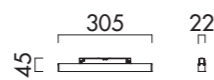

				A	B
15/2155.22	Lichtelement / Light element, 305 mm	Acryldiffusor satiniert / Satinised acrylic diffuser	7,2 W, B 730 / N 380 lm	170 mm	305 mm
15/2156.22	Lichtelement / Light element, 605 mm	Acryldiffusor satiniert / Satinised acrylic diffuser	14,4 W, B 1470 / N 760 lm	170 mm	605 mm

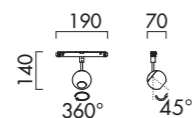
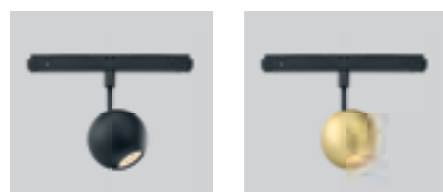

				A	B
15/2150.22	BALL Strahler / BALL spot, Ø 70 mm	mattschwarz / matt black	8,5 W, B 880 / N 550 lm, 36°	190 mm	25 mm
15/2150.28	BALL Strahler / BALL spot, Ø 70 mm	mattschwarz-mattgold / matt black-matt gold	8,5 W, B 880 / N 550 lm, 36°	190 mm	25 mm

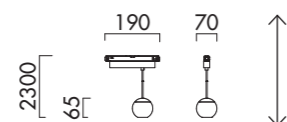

höhenverstellbar / adjustable height

				A	B
16/2150.22	BALL Pendel / BALL pendant, Ø 70 mm	mattschwarz / matt black	8,5 W, B 880 / N 550 lm, 36°	190 mm	160 mm
16/2150.28	BALL Pendel / BALL pendant, Ø 70 mm	mattschwarz-mattgold / matt black-matt gold	8,5 W, B 880 / N 550 lm, 36°	190 mm	160 mm

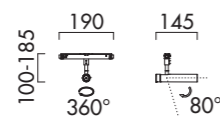

				A	B
15/2151.22	TUBE Strahler / TUBE spot	mattschwarz / matt black	4,5 W, B 520 / N 270 lm, 38°	190 mm	25 mm
15/2151.28	TUBE Strahler / TUBE spot	mattschwarz-mattgold / matt black-matt gold	4,5 W, B 520 / N 270 lm, 38°	190 mm	25 mm

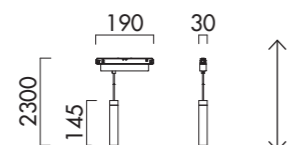

höhenverstellbar / adjustable height

				A	B
16/2151.22	TUBE Pendel / TUBE pendant	mattschwarz / matt black	4,5 W, B 520 / N 270 lm, 38°	190 mm	160 mm
16/2151.28	TUBE Pendel / TUBE pendant	mattschwarz-mattgold / matt black-matt gold	4,5 W, B 520 / N 270 lm, 38°	190 mm	160 mm

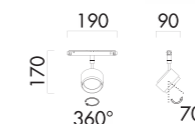

Ausstrahlwinkel verstellbar 15-45° / adjustable beam angle 15-45°

				A	B
15/2152.22	PONT Strahler / PONT spot	mattschwarz / matt black	10 W, B 960 / N 405 lm	190 mm	25 mm
15/2152.28	PONT Strahler / PONT spot	mattschwarz-mattgold / matt black-matt gold	10 W, B 960 / N 405 lm	190 mm	25 mm

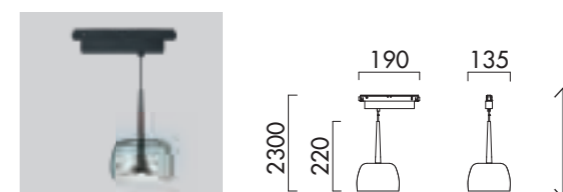

höhenverstellbar / adjustable height

				A	B
16/2153.22	FLUTE Pendel / FLUTE pendant	mattschwarz / matt black	6 W, B 680 / N 440 lm	190 mm	160 mm
16/2153.22/5284	FLUTE Pendel / FLUTE pendant	Glas klar / Glass clear	6 W, B 680 / N 440 lm	190 mm	160 mm
16/2153.22/5285	FLUTE Pendel / FLUTE pendant	Glas grau / Glass gray	6 W, B 680 / N 440 lm	190 mm	160 mm

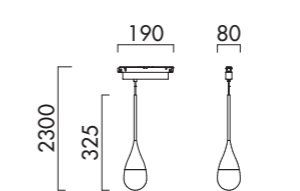

höhenverstellbar / adjustable height

				A	B
16/2154.22	DEEP Pendel / DEEP pendant, Ø 80 mm	mattschwarz / matt black	5 W, B 560 / N 450 lm	190 mm	160 mm
16/2154.28	DEEP Pendel / DEEP pendant, Ø 80 mm	mattschwarz-mattgold / matt black-matt gold	5 W, B 560 / N 450 lm	190 mm	160 mm

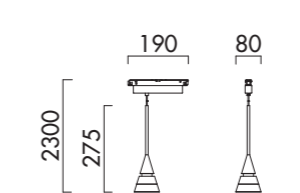

höhenverstellbar / adjustable height

				A	B
16/2158.22	CONE Pendel / CONE pendant, Ø 80 mm	mattschwarz / matt black	5 W, B 560 / N 440 lm	190 mm	160 mm
16/2158.28	CONE Pendel / CONE pendant, Ø 80 mm	mattschwarz-mattgold / matt black-matt gold	5 W, B 560 / N 440 lm	190 mm	160 mm





VIGO

THE MODULAR LED SYSTEM

VIGO ist ein modular erweiterbares System, das insbesondere mit seiner minimalistischen Aufbauhöhe, hoher Flexibilität, einfacher Planbarkeit und Montagefreundlichkeit überzeugt. VIGO-Konverter können wahlweise im System integriert oder in Wand bzw. Decken verbaut werden. VIGO ist über die mitgelieferte Fernbedienung komfortabel schalt- und dimmbar.

VIGO is an impressive modular system, capable of being expanded easily and notable for its minimal installation height, high degree of flexibility, and ease of planning and assembly. VIGO drivers can be integrated into your system or built into walls or ceilings. With VIGO you can easily dim the lights or switch them on or off using the remote control device that comes with this product.



VIGO

Systemleistung 86,4 W / system wattage 86,4 W - 11430 lm
Systemlänge 4680 mm / system length 4680 mm
externe Einspeisung / external power supply



- 1 3 x 15/1602.18 LED-Modul 28,8 W / LED-module 28,8 W
- 2 1 x 6021 Konverter 100 W / converter 100 W
- 3 1 x 6010.18 Endeinspeisung / end feeder
- 4 1 x 6001.18 Linienverbinder / line connector
- 5 1 x 6002.18 Verbinder 90° / 90°-connector
- 6 1 x 6000.18 Endstück / end fitting





VIGO

Systemleistung 93,6 W / system wattage 93,6 W - 10860 lm

Systemlänge 4020 mm / system length 4020 mm

systemintegrierte Einspeisung / intergrated power supply



- 1 2 x 15/1602.18 LED-Modul 28,8 W / LED-module 28,8 W
- 2 2 x 35/1730.18 End-LED-Strahlermodul 12 W / End-Spotlight 12 W
- 3 1 x 35/1731.18 Mittel-LED-Strahlermodul 12 W / Middle-LED-Spotlight 12 W
- 4 1 x 6021 Konverter 100 W / converter 100 W





VIGO

Systemleistung 96 W / system wattage 96 W - 12700 lm
 Systemlänge 5520 mm / system length 5520 mm
 systemintegrierte Einspeisung / intergrated power supply

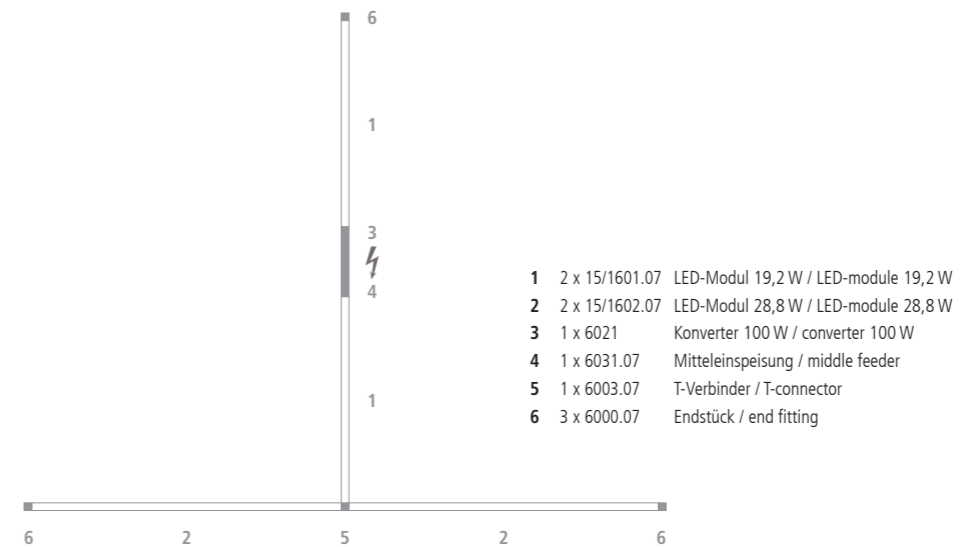



VIGO

Systemleistung 97,9 W / system wattage 97,9 W - 12950 lm
 Systemlänge 5325 mm / system length 5325 mm
 externe Einspeisung / externe power supply



- 1 3 x 15/1602.18 LED-Modul 28,8 W / LED-module 28,8 W
- 2 1 x 15/1600.18 LED-Modul 11,5 W / LED-module 11,5 W
- 3 1 x 6021 Konverter 100 W / converter 100 W
- 4 1 x 6011.18 Linieneinspeisung / line feeder
- 5 2 x 6002.18 Verbinder 90° / 90°-connector
- 6 2 x 6000.18 Endstück / end fitting





- System stufenlos dimmbar mit Memory-Funktion
- Steuerung wahlweise über Fernbedienung oder Wandsender
- bis zu 5 Fernbedienungen/Wandsender je System möglich
- eine Fernbedienung/Wandsender für mehrere Systeme möglich
- System infinitely dimmable with memory capacity
- control optional by remote control or wall-mounted transmitter
- up to 5 remote control/wall-mounted transmitter for each system
- run multiple systems by one remote control or wall-mounted transmitter



VIGO

Aufbausystem für Decken
oder Wandmontage
surface mounted ceiling
or wall system
3000 K, CRI > 85



Bestellschritte für Ihr VIGO System.
How to configure your VIGO system.

Bitte max. mögliche Gesamtsystemleistung von 100 W beachten.
Please be aware of max. system wattage of 100 W.

Einspeisung power supply		Lichtmodule / Verbinder Light modules / connectors		
1	+	2 extern external oder/or 3 intern internally	+	4 + 5

Bitte den Farbschlüssel der gewünschten Oberfläche zu
den Artikelnummern ergänzen:

Please complete the item number with colour code:

- .07 - mattweiß / white mat**
- .18 - mattnickel eloxiert / nickel mat anodised**

1 Konverter inkl. Dimm-Modul und Fernbedienung converter incl. dim-module and remote control



60 W
6020

100 W
6021

Konverter inkl. Dimm-Modul und Wandsender converter incl. dim-module and wall transmitter



60 W
6020.1

100 W
6021.1



* inkl. Magnetbefestigung / * incl. magnetic mount

2 Verbinder* inkl. Kabeleinspeisung (L 900 mm) für extern verbaute Konverter connectors* incl. cable feeder (L 900 mm) for external converters



Endstück / end fitting
6010...



Linienverbinder / line connector
6011...

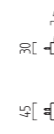

90°-Verbinder / 90°-connector
6012...



T-Verbinder / T-connector
6013...



3 Deckengehäuse für Konverter housing for converter



Endeinspeisung / end feeder
6030...

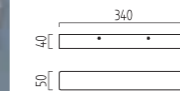

Mitteinspeisung / middle feeder
6031...

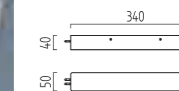

8,2 W, B 940 / N 720 lm



Endeinspeisung / end feeder
25/1730...



12,2 W, B 1410 / N 1080 lm



Endeinspeisung / end feeder
35/1730...



Mitteinspeisung / middle feeder
25/1731...



Mitteinspeisung / middle feeder
35/1731...



**4 Lineare LED-Module*
linear LED-modules***

Acryldiffusor satiniert
acrylic diffuser satinised

11,5 W, B 1600 / N 1310 lm
15/1600...



18 W, B 2760 / N 2180 lm
15/1601...

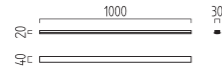

26,5 W, B 4210 / N 3270 lm
15/1602...

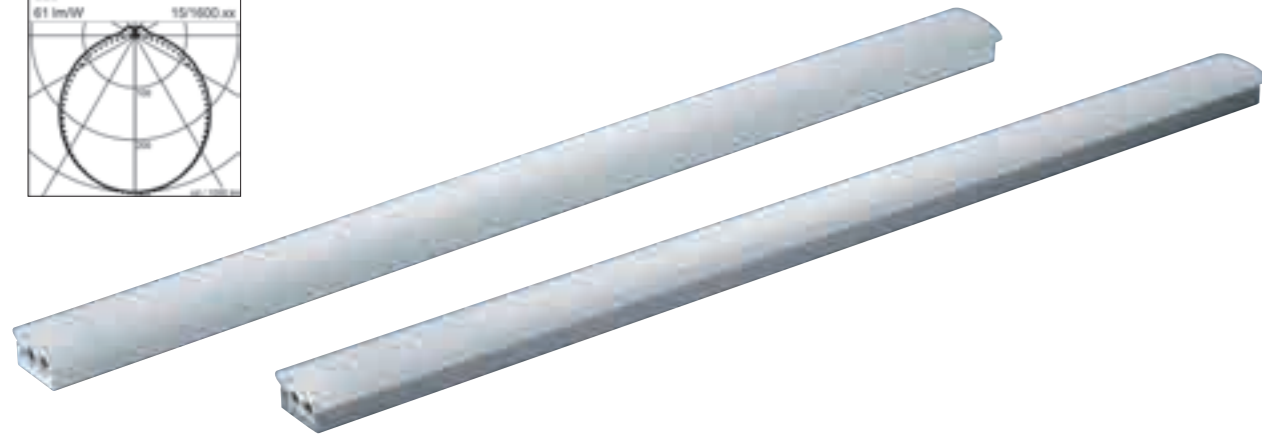
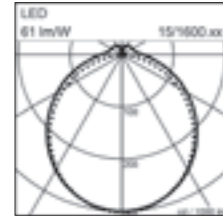
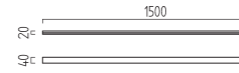

**5 LED-Strahlermodule
LED-spotlights**

4 W, B 470 / N 360 lm



Endstück / end fitting
15/1700...



Linienverbinder / line connector
15/1701...



90°-Verbinder / 90°-connector
15/1702...



T-Verbinder / T-connector
15/1703...



**5 Verbinder*
connectors***



Endstück / end fitting
6000...



Linienverbinder / line connector
6001...



90°-Verbinder / 90°-connector
6002...



T-Verbinder / T-connector
6003...



Verbinder 90° vertikal,
Decke-Wand / Wand-Wand
connector 90° vertical,
ceiling-wall / wall-wall
6004...



* inkl. Magnetbesfestigung / * incl. magnetic mount

8,2 W, B 940 / N 720 lm



Endelement / end element
25/1730...



12,2 W, B 1410 / N 1080 lm



Endelement / end element
35/1730...



Mittelement / middle element
25/1731...



Mittelement / middle element
35/1731...



LIGHT IS OUTSIDE®

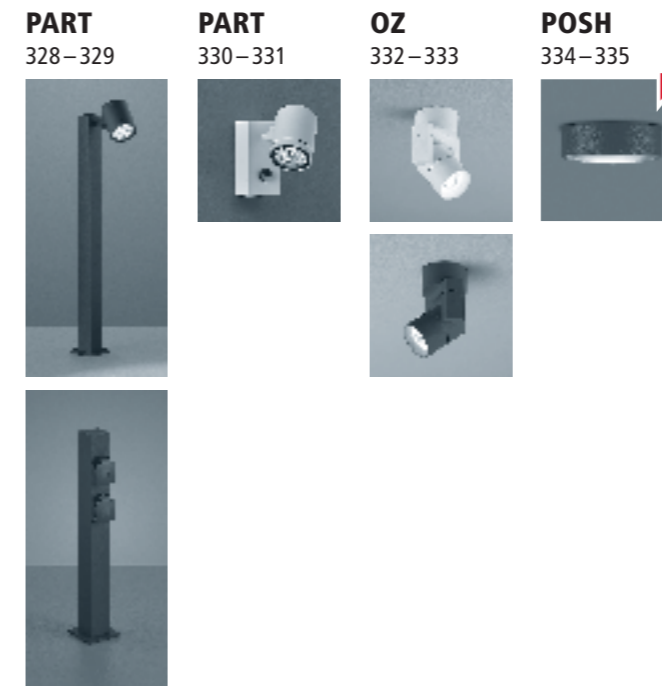
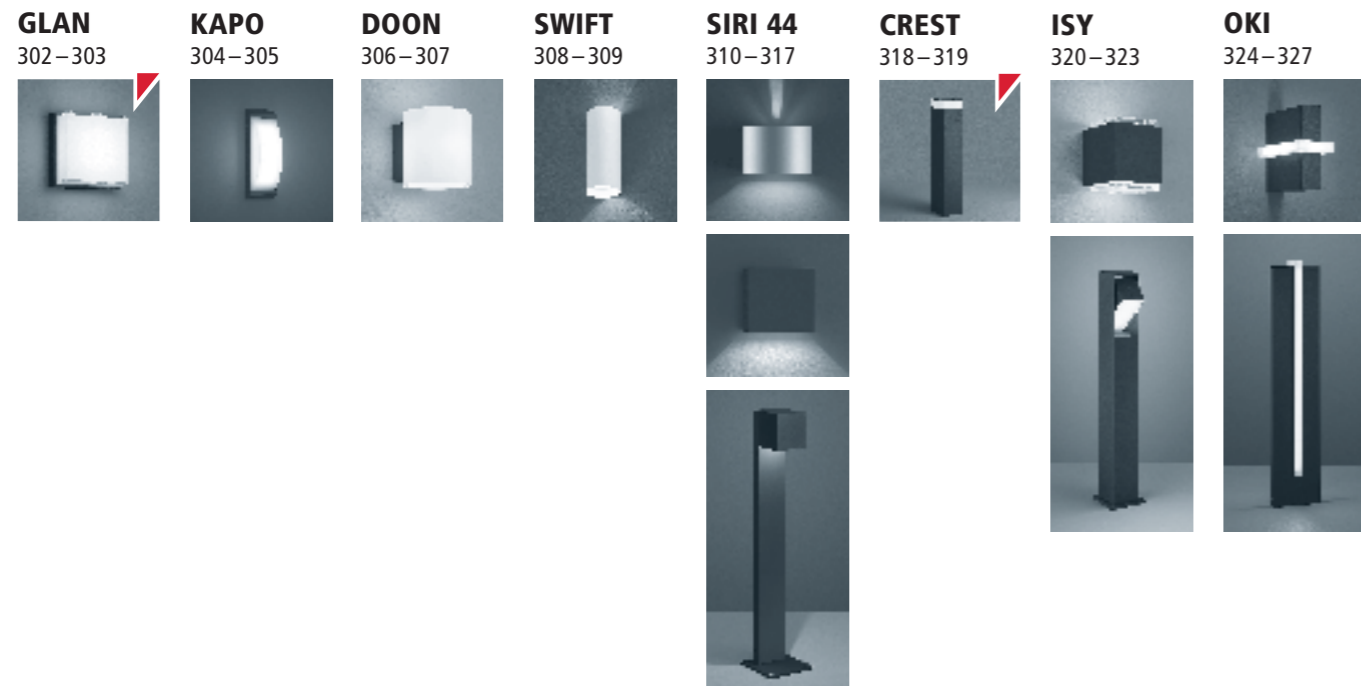
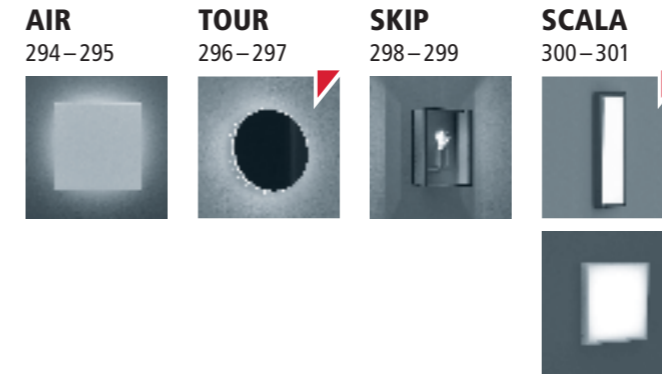
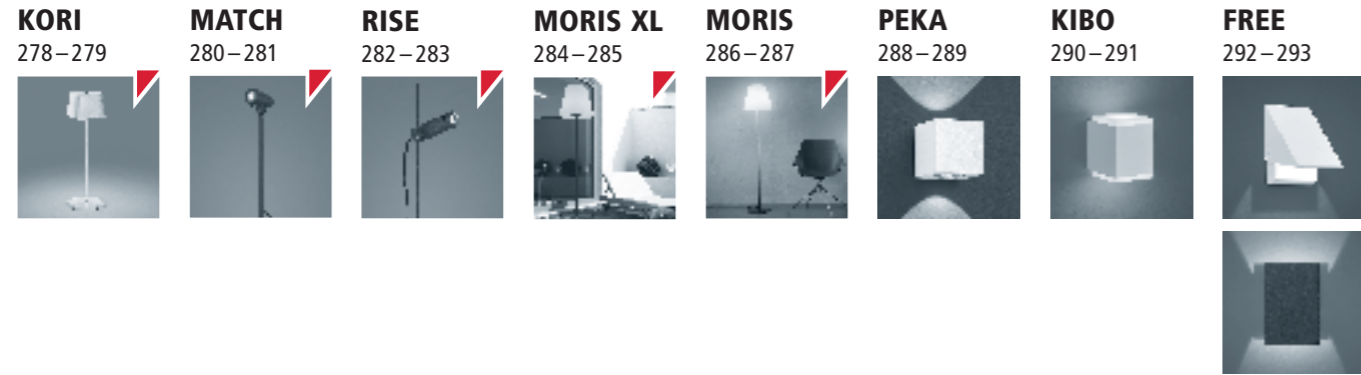

AIR	294–295
CREST	318–319
DOON	306–307
DRY	336–337
FREE	292–293
GLAN	302–303
ISY	320–323
KAPO	304–305
KIBO	290–291
KORI	278–279
MATCH	280–281
MONO	340–341
MORIS	286–287
MORIS XL	284–285
OKI	324–327
OZ	332–333
PART	328–329
PART	330–331
PEKA	288–289
PIER	342–343
PIER 2	344–345
POSH	334–335
RISE	282–283
SCALA	300–301
SIRI 44	310–317
SKIP	298–299
SKY	338–339
SWIFT	308–309
TENDO	346–347
TOUR	296–297
Zubehör / Accessories	349

KORI

LED  IP65

Mobile Akkuleuchte
wiederaufladbar, inkl. USB-Ladekabel
Akku-Laufzeit ca. 8 Std. (100% Lichtleistung)
portable battery light
rechargeable, incl. USB charging cable
battery operating time 8 hrs (100% light intensity)



2,2 W, 2700 K, B 210 / N 120 lm, CRI > 85



mattweiß / white mat
19/2100.07
mattschwarz / black mat
19/2100.98

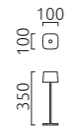



MATCH

LED IP65

Aluminium Druckguss
Sicherheitsglas klar
graphit
inkl. Steckerleitung ca. 2,5 m
Abstrahlwinkel verstellbar 15°-60°
die casting aluminium
tempered glass clear
graphite
incl. power supply line 2,5 m
beam angle adjustable 15°-60°

11 W, 3000 K, B 1140 / N 690 lm, CRI > 85



A192001.93

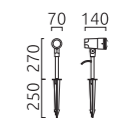

www.helestra.de/match 281

RISE

LED  IP65

Aluminium Druckguss
Glas klar
graphit
höhenverstellbar
inkl. Steckerleitung ca. 2,5 m
Abstrahlwinkel 36°
die-casting aluminium
glass clear
graphite
height adjustable
incl. Power supply line 2,5m
beam angle 36°

4,2 W, 3000 K, B 500 / N 210 lm, CRI > 90

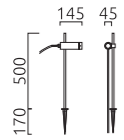

A192006.93



MORIS XL

E27  IP44

graphit
witterungsbeständiges Acryl weiß
Zuleitungslänge 3 m
graphite
weather resistant white acrylic
power supply line 3 m

1 x E27

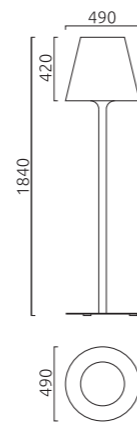

17/2166.93

Leuchtmittel nicht im Lieferumfang
bulb not included



MORIS

E27 IP65



witterungsbeständiges Acryl, weiß
Zuleitungslänge 4,5 m
weather resistant white acrylic
power supply line 4,5 m

1 x E27

silbergrau / silver grey
19/1266.46

graphit / graphite
19/1266.93

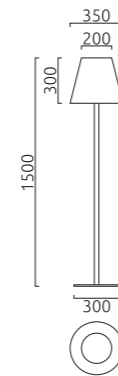

Leuchtmittel nicht im Lieferumfang
bulb not included



PEKA

LED IP54

Aluminium massiv
solid aluminium

5 W, 3000 K, B 540 / N 380 lm, CRI > 90

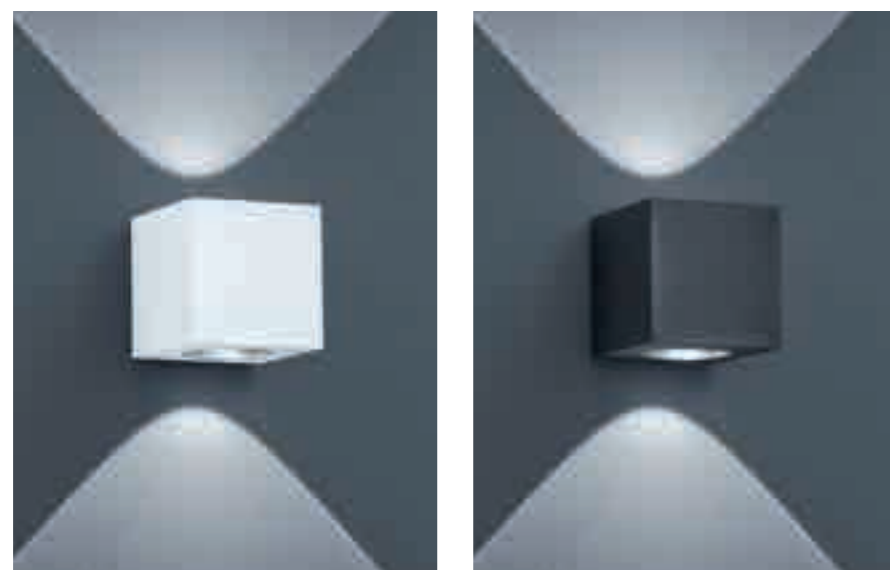

mattweiß / white mat
A28807.07

graphit / graphite
A28807.93

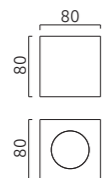



KIBO

LED IP54



Aluminium
Acryl weiß
aluminium
acrylic white

11 W, 3000 K, B 1140 / N 520 lm, CRI > 85

mattweiß / white mat
A28612.07

grahpit / graphite
A28612.93

90 80
90 80





FREE

LED IP54

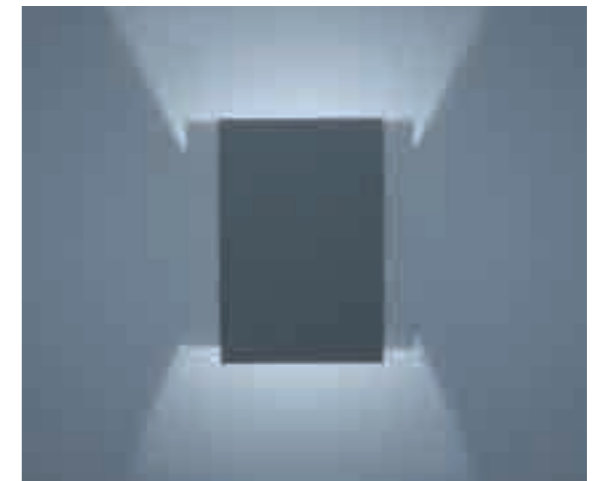

Aluminium massiv
Lichtaustritt verstellbar
solid aluminium
light beam adjustable

10 W, 3000 K, B 990 / N 520 lm, CRI > 90

mattweiß / white mat

A18605.07

graphit / graphite

A18605.93

150 70 100



AIR

LED IP65

Aluminium massiv
solid aluminium

15 W, 3000 K, B 1590 / N 410 lm, CRI > 90



mattweiß / white mat
A18607.07

graphit / graphite
A18607.93

45 150
150 





TOUR

LED IP65

Aluminium Druckguss
Sicherheitsglas
die-casting aluminium
tempered glass

13 W, 3000 K, B 1360 / N 350 lm, CRI > 90



Glas weiß - Rand klar / glass white - edge clear
A182004.07

Glas schwarz - Rand klar / glass black - edge clear
A182004.98

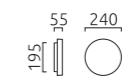



SKIP

E27  IP44

Aluminium massiv
graphit
Acrylglas klar
solid aluminium
graphite
acrylic glass clear

1 x E27



A18805.93

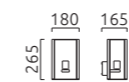

Leuchtmittel nicht im Lieferumfang
bulb not included



www.helestra.de/skip

SCALA

LED IP44

Acryldiffusor weiß
acrylic diffuser white



13 W, 3000 K, B 1400 / N 840 lm, CRI > 85

Edelstahl / stainless steel

A18454.86

graphit / graphite

A18454.93

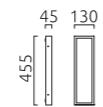

27 W, 3000 K, B 2990 / N 1790 lm, CRI > 85

Edelstahl / stainless steel

A18457.86

graphit / graphite

A18457.93

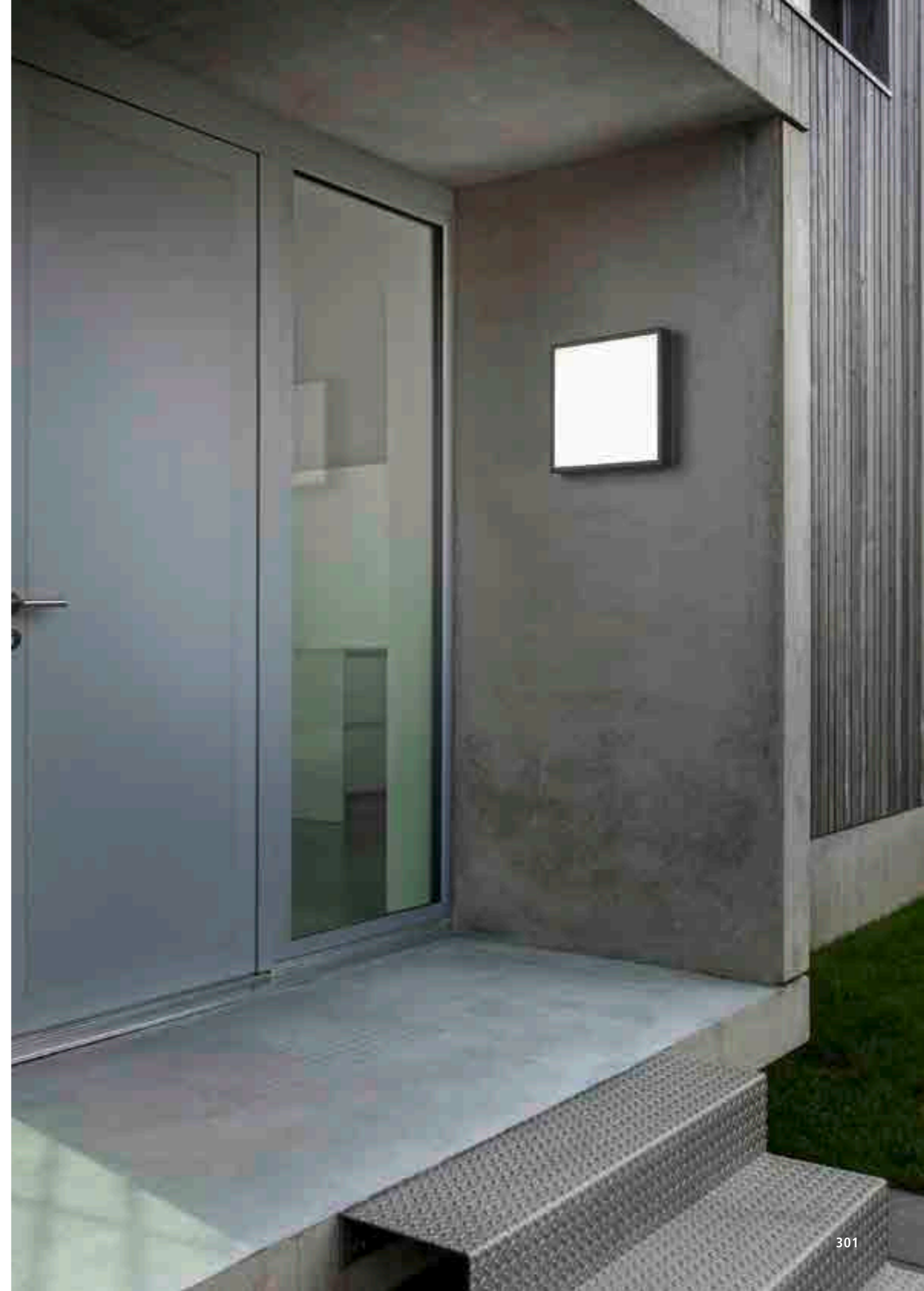
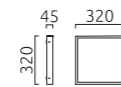



GLAN

LED IP65

Aluminium Druckguss
Sicherheitsglas satiniert, Kanten klar poliert
graphit
die-casting aluminium
tempered glass satinised, edges clear polished
graphite

10 W, 2900 K, B 990 / N 520 lm, CRI > 90



A182007.93

160 75
160 □ ▮

Beschriftung nicht im Lieferumfang enthalten!
Labelling not included in delivery!



KAPO

LED   IP54



Aluminium
graphit
Acryl satiniert
aluminium
graphite
acrylic satinised

8 W, 3000 K, B 820 / N 510 lm, CRI > 85

A18610.93



DOON

LED IP54

Aluminium massiv
graphit
Glas opal
solid aluminium
graphite
glass opal

230 V - 7,5 W, 3000 K, B 880 / N 410 lm, CRI > 85



A18907.93

150 120 175 140
85





SWIFT

LED  IP65



Aluminium massiv
solid aluminium

7 W, 3000 K, B 720 / N 590 lm, CRI > 90

mattweiß / white mat
A28704.07

graphit / graphite
A28704.93

75
180
75

•



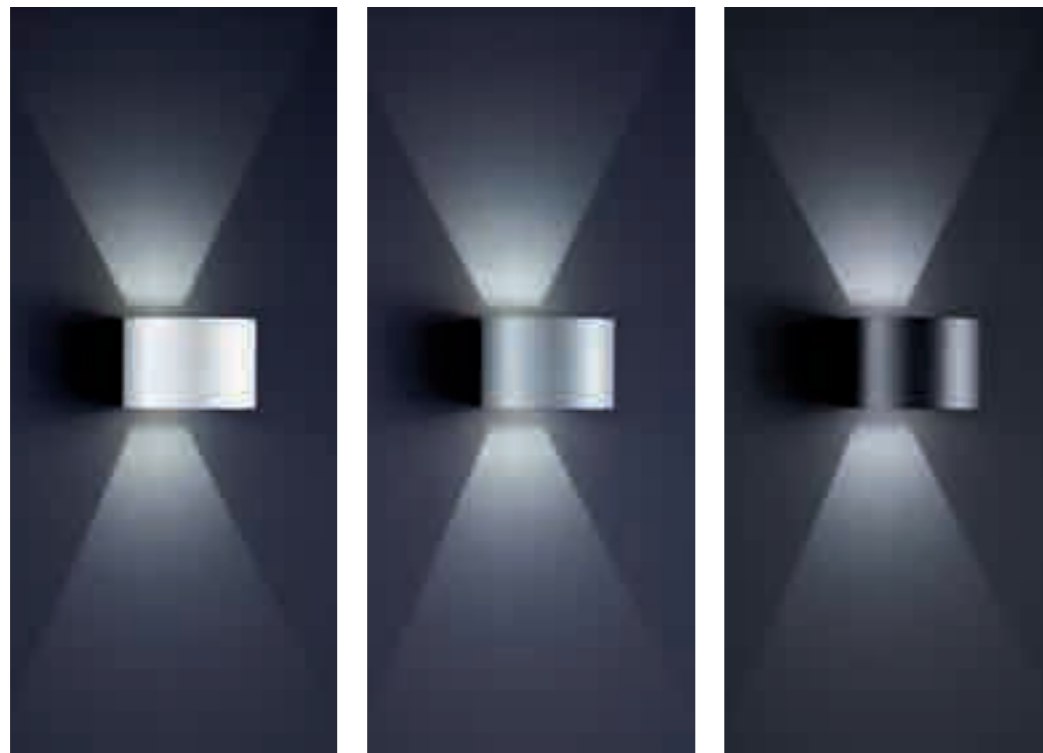

Aluminium massiv
solid aluminium

7 W, 3000 K, B 720 / N 390 lm, CRI > 90

mattweiß / white mat

A28342.07

silbergrau / silver grey

A28342.46

mattschwarz / black mat

A28342.93

150
100
125

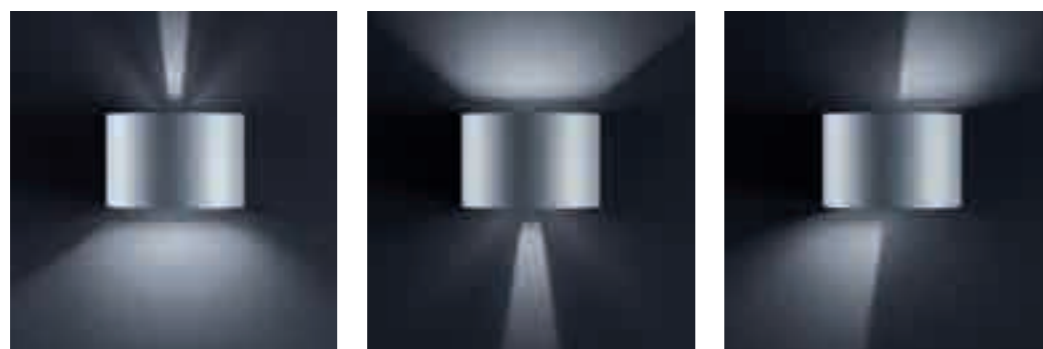

Lichtaustritt stufenlos verstellbar
light beam infinitely adjustable



SIRI 44-R

LED  IP54



SIRI 44

LED  IP54

Aluminium massiv
solid aluminium

7 W, 3000 K, B 720 / N 390 lm, CRI > 90

 ¹⁰⁰ ¹⁰⁰
□ □

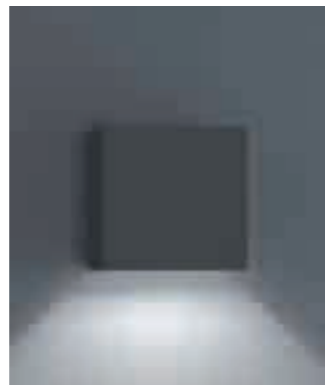
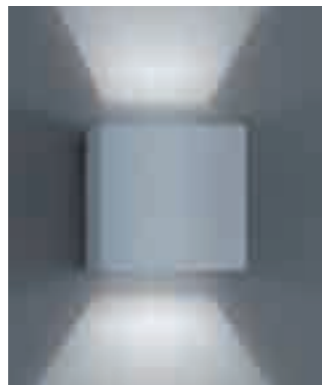
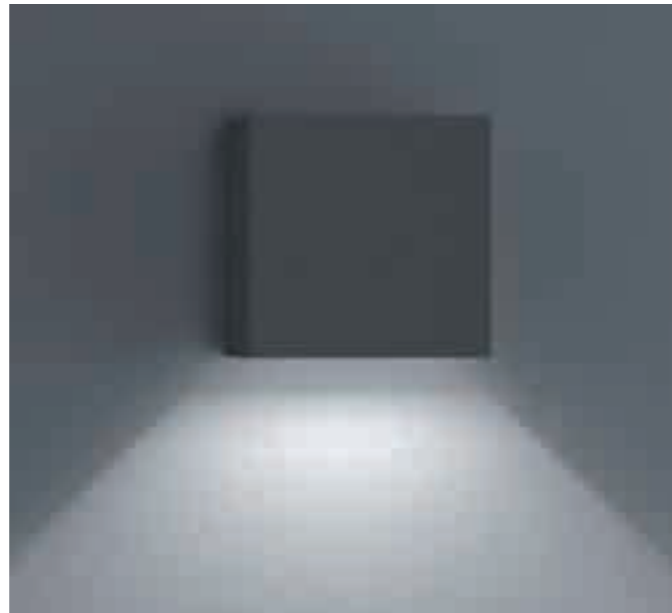
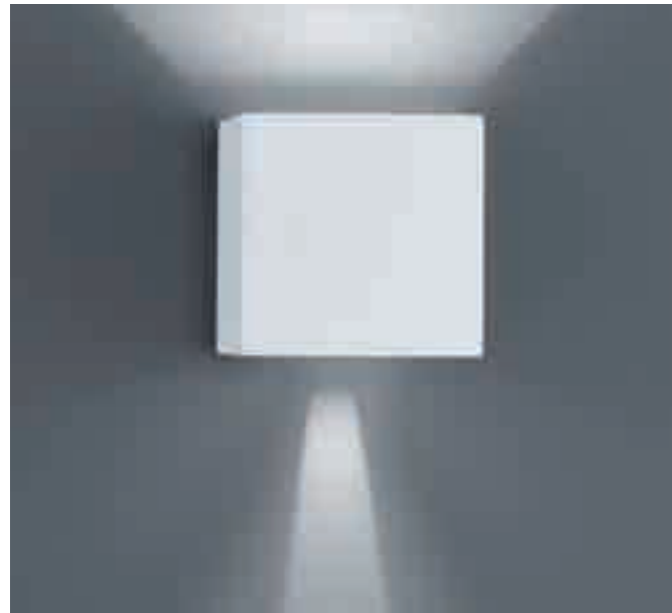

mattweiß / white mat

A28242.07

mattnickel eloxiert / nickel mat anodised

A28242.18

silbergrau / silver grey

A28242.46

graphit / graphite

A28242.73

mattschwarz / black mat

A28242.93



Lichtaustritt stufenlos verstellbar
light beam infinitely adjustable



SIRI 44-L

LED  IP54



Aluminium massiv
solid aluminium

150 150 150
150 150 150

15 W, 3000 K, B 1550 / N 850 lm, CRI > 90

mattweiß / white mat
A28442.07

mattnickel eloxiert / nickel mat anodised
A28442.18

silbergrau / silver grey
A28442.46

graphit / graphite
A28442.73

mattschwarz / black mat
A28442.93



SIRI 44

LED IP54

Aluminium massiv
graphit
solid aluminium
graphite

7 W, 3000 K, B 680 / N 320 lm, CRI > 90

A19802.73

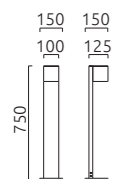



CREST

LED IP65

Aluminium Druckguss
 Glas satiniert
 graphit
 die-casting aluminium
 glass satinised
 graphite

14 W, 3000 K, B 1430 / N 510 lm, CRI > 90

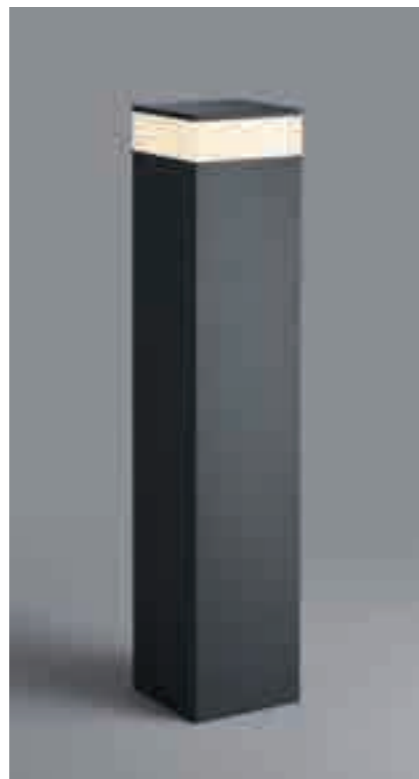

Zubehör für Bodenbefestigung
 accessories for floor assembly
 Seite / page 349

A192002.93



www.helestra.de/crest 319



ISY

LED IP54

Aluminium massiv
graphit
Glas satiniert
schwenkbar
solid aluminium
graphite
glass satinised
tiltable



13 W, 3000 K, B 1440 / N 810 lm, CRI > 85
A19901.93

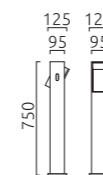

Zubehör für Bodenbefestigung
accessories for floor assembly
Seite / page 349



ISY

LED IP54

Aluminium massiv
graphit
Glas satiniert
solid aluminium
graphite
glass satinised



11 W, 3000 K, B 1120 / N 690 lm, CRI > 85
A15901.93

120
135
120



20 W, 3000 K, B 2150 / N 1090 lm, CRI > 85
A28901.93

120 120
145
120





OKI

LED  IP54

Aluminium massiv
Acrylglas satiniert
solid aluminium
acrylic glass satinised

8 W, 3000 K, B 880 / N 520 lm, CRI > 85



graphit / graphite
A18803.93

160 170



OKI

LED IP54

Aluminium massiv
Acrylglas satiniert
solid aluminium
acrylic glass satinised

25 W, 3000 K, B 2810 / N 1360 lm, CRI > 85



graphit / graphite
A19803.93

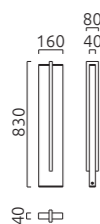

Zubehör für Bodenbefestigung
accessories for floor assembly
Seite / page 349



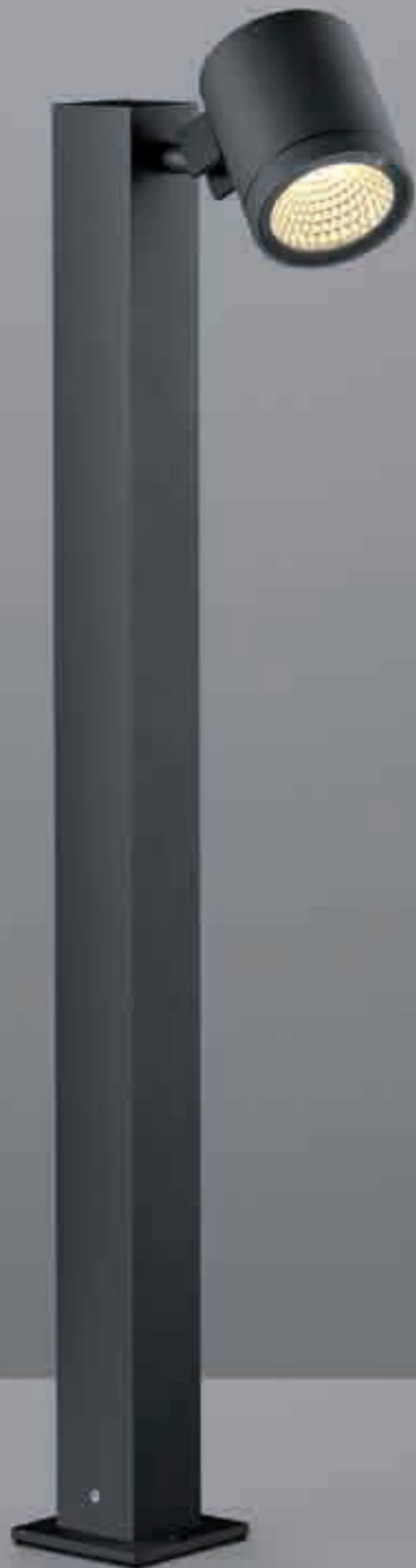

PART

LED IP55

Aluminium massiv
graphit
dreh- und schwenkbar
solid aluminium
graphite
rotatable and tiltable

230 V - 10 W, 3000 K, B 1080 / N 740 lm, CRI > 90
A19906.93

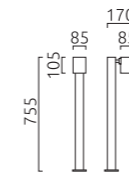

IP54

2 x Steckdose IP54 / 2 x sockets IP54
A19999.93

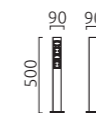

Zubehör für Bodenbefestigung
accessories for floor assembly
Seite / page 349



PART

LED  IP55

Aluminium massiv
dreh- und schwenkbar
inkl. PIR-Bewegungsmelder
solid aluminium
rotatable and tiltable
incl. PIR motion sensor

230 V - 10 W, 3000 K, B 1080 / N 740 lm, CRI > 90



mattweiß / white mat

A18806.07

graphit / graphite

A18806.93

150 105 85 155





OZ

LED  IP54

Aluminium massiv
dreh- und schwenkbar
solid aluminium
rotatable and tiltable

230 V - 3,5 W, 3000 K, B 360 / N 260 lm, CRI > 90







mattweiß / white mat

A18815.07

graphit / graphite

A18815.93

145  90 
70  70 



POSH

LED IP65

Aluminium Druckguss
Glaslinse klar
die-casting aluminium
glass lens clear

230 V - 6 W, 3000 K, B 520 / N 320 lm, CRI > 85



graphit / graphite
A152005.93

mattweiß / white mat
A152005.07

40
110

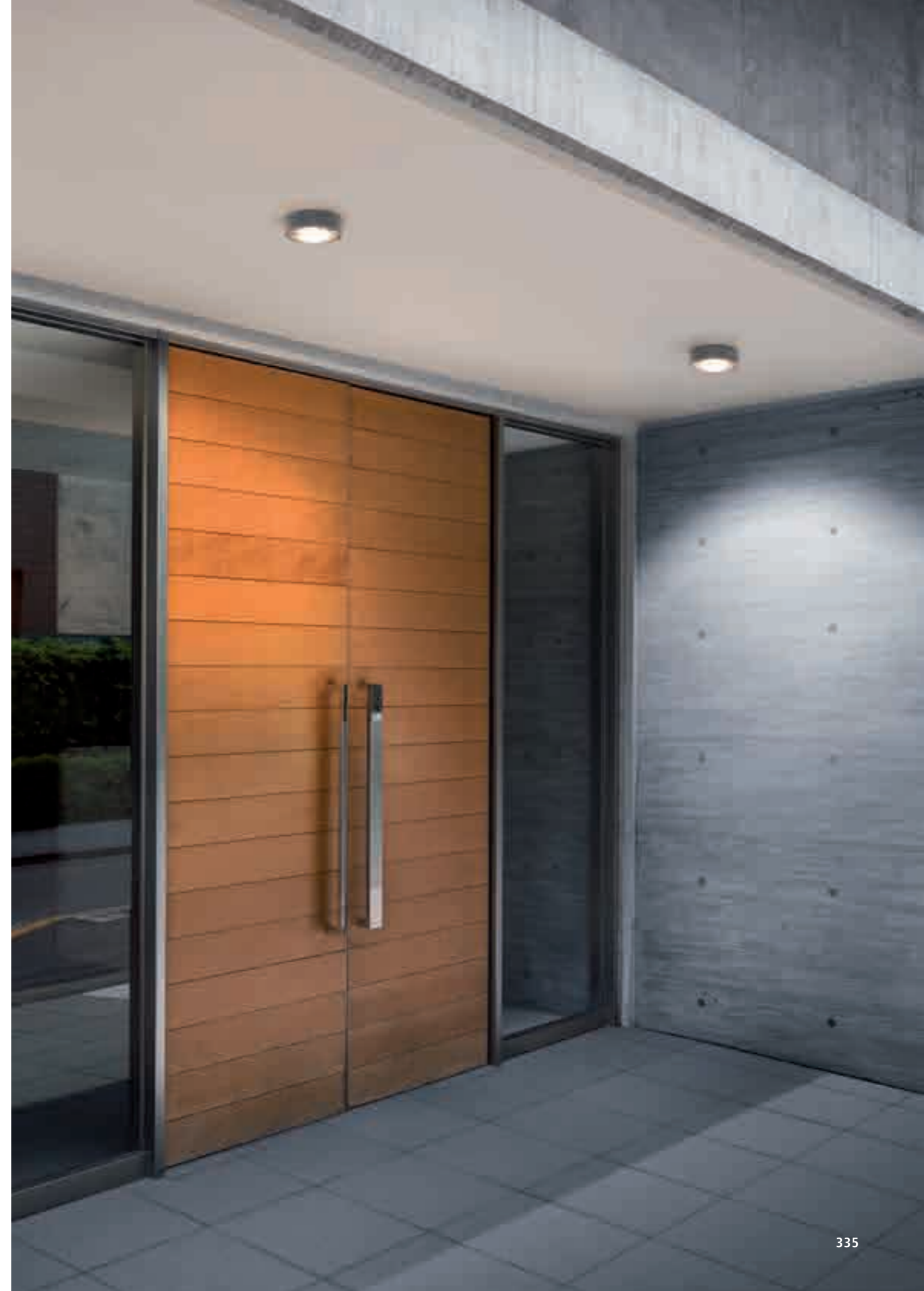



DRY

LED IP65



Aluminium massiv
inkl. Montagegehäuse
solid aluminium
incl. mounting box

8 W, 3000 K, B 820 / N 550 lm, CRI > 90

mattweiß / white mat

A19702.07

graphit / graphite

A19702.93

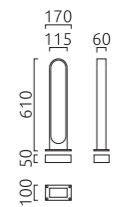

Zubehör für Bodenbefestigung
accessories for floor assembly
Seite / page 349



www.helestra.de/dry

SKY

LED IP54

Aluminium massiv
graphit
solid aluminium
graphite

8,5 W, 3000 K, B 840 / N 420 lm, CRI > 90
A19501.93

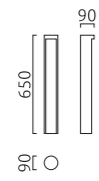

Zubehör für Bodenbefestigung
accessories for floor assembly
Seite / page 349





MONO

LED IP54



Aluminium massiv
solid aluminium

10 W, 3000 K, B 1090 / N 290 lm, CRI > 90

mattweiß / white mat
A19700.07

graphit / graphite
A19700.93

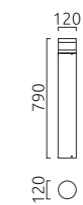

Zubehör für Bodenbefestigung
accessories for floor assembly
Seite / page 349





PIER

LED IP55

Aluminium massiv
graphit
Acryldiffusor satiniert
solid aluminium
graphite
acrylic diffuser satinised

52 W, 3000 K, B 6530 / N 1790 lm,
CRI > 85
A39500.93

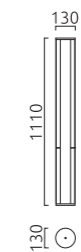

Zubehör für Bodenbefestigung
accessories for floor assembly
Seite / page 349



PIER 2

LED IP54

Aluminium massiv
graphit
Acryl satiniert
solid aluminium
graphite
acrylic satinised



18 W, 3000 K, B 2070 / N 810 lm, CRI > 85
A19902.93



Zubehör für Bodenbefestigung
accessories for floor assembly
Seite / page 349

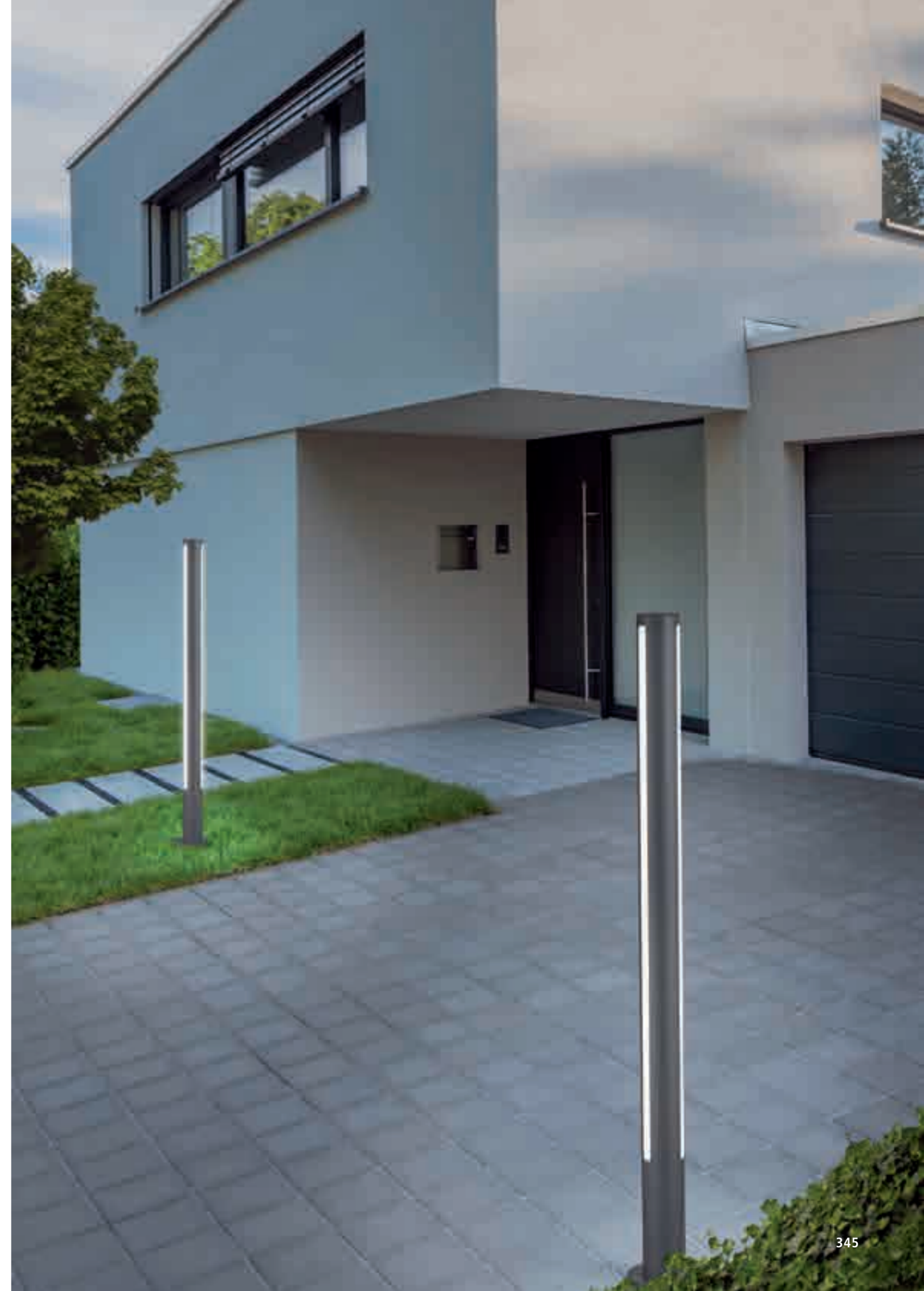



TENDO

LED IP55

Aluminium massiv
graphit
Acryldiffusor satiniert
solid aluminium
graphite
acrylic diffuser satinised



43 W, 3000 K, B 5800 / N 2030 lm, CRI > 80
A29412.93

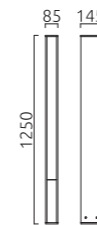

61 W, 3000 K, B 7540 / N 2640 lm, CRI > 80
A29912.93

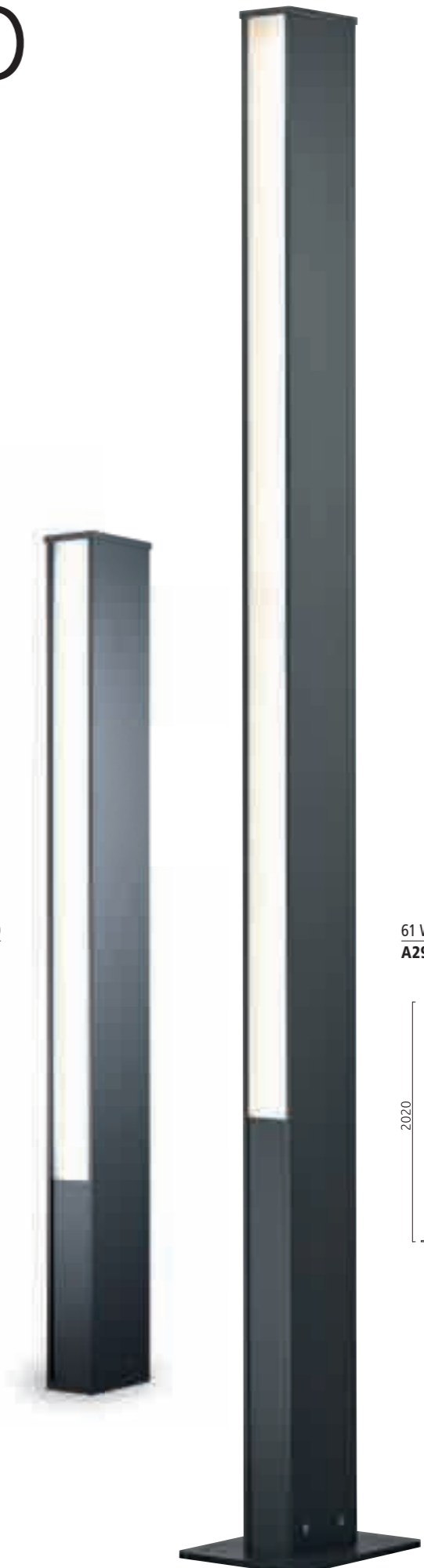
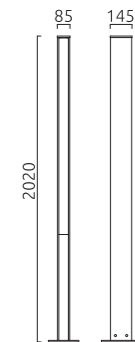

Auf Anfrage sind Sonderfarben nach RAL möglich.
Special colours (RAL) on request.

Zubehör für Bodenbefestigung
accessories for floor assembly
Seite / page 349



SIRI 44

Zubehör Außenleuchten Accessories outdoor lighting

Montage von Pollerleuchten

Alle Pollerleuchten können ohne Zubehör auf einem Fundament verschraubt oder alternativ mit einem Erdstück und einer Adapterplatte gemäß unten stehender Tabelle im Erdboden befestigt werden.

Mounting of bollards

All bollards can be bolted to a solid base without accessories or mounted in-ground with anchorage unit and adapter plate (see list below).

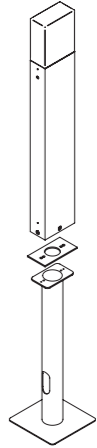

Serie	Erdstück - Stahl verzinkt anchorage unit - steel galvanised	Adapterplatte - Stahl verzinkt adapter plate - steel galvanised
CREST	A19900	9035
DRY	A19900	9028
ISY	A19900	9034
MONO	A19900	9029
OKI	A19900	9032
PART	A19900	9030
PIER	A19900	9024
PIER 2	A19900	9033
SIRI 44	A19900	9031
SKY	A19900	9019
TENDO A29412...	A19900	9018
TENDO A29912...	A19900	9007

A19900

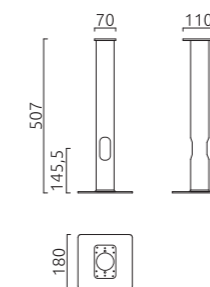

Art.-Nr./art. no.	Seite/page	Art.-Nr./art. no.	Seite/page	Art.-Nr./art. no.	Seite/page	Art.-Nr./art. no.	Seite/page	Art.-Nr./art. no.	Seite/page	Art.-Nr./art. no.	Seite/page	Art.-Nr./art. no.	Seite/page	Art.-Nr./art. no.	Seite/page
15...		15/1938.26	180	15/2151.28	256	16/2154.22	257	18/2024.04	198	26/1892.07	97	6013.07	271	A18607.93	294
15/1440.08/5146	234	15/1944.07	87	15/2152.22	257	16/2154.28	257	18/2025.04	198	26/1893.07	95	6013.18	271	A18610.93	304
15/1441.08/5149	234	15/1945.06	148	15/2152.28	257	16/2158.22	257	18/2026.04	198	26/1893.22	95	6020	270	A18803.93	325
15/1552.07	241	15/1945.07	148	15/2155.22	256	16/2158.28	257	18/2031.04	205	26/2009.07	32	6020.1	270	A18805.93	299
15/1552.22	241	15/1945.22	148	15/2156.22	256	16/2214.07	11	18/2032.04	205	26/2009.22	32	6021	270	A18806.07	330
15/1552.26	241	15/1946.06	151	15/2164.07	171	16/2214.22	11	18/2033.04	205	26/2108.06/5303	12	6021.1	270	A18806.93	330
15/1553.07	240	15/1946.07	151	15/2164.22	171	17...		18/2035.25	126	26/2108.22/5303	12	6030.07	271	A18815.07	333
15/1553.22	240	15/1946.22	151	15/2210.22	117	17/1036.07	56	18/2037.04	197	26/2118.62	27	6030.18	271	A18815.93	333
15/1553.26	240	15/1950.04	223	15/2211.22	117	17/1036.22	56	18/2037.22	194	26/2119.62	28	6031.07	271	A18907.93	306
15/1558.07	143	15/1951.04	223	15/2215.07-07	152	17/1240.34/5045	54	18/2038.04	197	27...		6031.18	271	A19...	
15/1600.07	272	15/1954.07	114	15/2215.07-09	152	17/1240.84/5045	54	18/2038.22	194	27/1502.19	53	6050	175	A192001.93	281
15/1600.18	272	15/1954.09	114	15/2215.07-22	152	17/1505.19	50	18/2039.04	197	27/1502.22	53	6051	175	A192002.93	318
15/1601.07	272	15/1954.22	114	15/2215.22-07	152	17/1505.22	50	18/2039.22	194	28...		61...		A192006.93	282
15/1601.18	272	15/1956.07	114	15/2215.22-09	152	17/1845.27/9276	61	18/2040.04	197	28/1225.07	135	6100	353	A19501.93	338
15/1602.07	272	15/1956.09	114	15/2215.22-22	152	17/1845.27/9283	61	18/2040.22	194	28/1225.25	135	66...		A19700.07	341
15/1602.18	272	15/1956.22	114	15/2216.07-07	152	17/1849.34/9289	62	18/2116.07	129	28/1427.07	133	6600	252	A19700.93	341
15/1629.07	239	15/1960.07-04	145	15/2216.07-09	152	17/1849.34/9290	62	18/2116.22	129	28/1427.25	133	6601	252	A19702.07	337
15/1629.26	239	15/1960.07-07	145	15/2216.07-22	152	17/2008.22/9319	59	18/2120.04	189	28/2114.07	90	6602	252	A19702.93	337
15/1632.07	100	15/1960.07-22	145	15/2216.22-07	152	17/2008.22/9320	59	18/2121.04	189	28/2114.28	90	6603	255	A19802.73	316
15/1632.22	100	15/1964.07	171	15/2216.22-09	152	17/2166.93	284	18/2122.04	189	29...		6604	255	A19803.93	326
15/1700.07	273	15/1964.22	171	15/2216.22-22	152	18...		18/2123.04	230	29/1844.07	87	6605	255	A19900	349
15/1700.18	273	15/1965.07	172	15/2254.07	113	18/1175.07	141	19...		35...		6606	252	A19901.93	321
15/1701.07	273	15/1965.22	172	15/2254.09	113	18/1175.26	141	19/1138.10	83	35/1730.07	271 / 273	6607	252	A19902.93	344
15/1701.18	273	15/1993.07	93	15/2254.22	113	18/1225.07	135	19/1139.10	83	35/1730.18	271 / 273	6608	252	A19906.93	329
15/1702.07	273	15/1993.09	93	16...		18/1225.25	135	19/1266.46	286	35/1731.07	271 / 273	6620	255	A19999.93	329
15/1702.18	273	15/1993.22	93	16/1504.19	41	18/1328.07	136	19/1266.93	286	35/1731.18	271 / 273	66/2108.06/5303	12	A28...	
15/1703.07	273	15/2012.00	177	16/1644.19	41	18/1328.26	136	19/1943.07	88	35/1806.07	159	66/2108.22/5303	12	A28242.07	312
15/1703.18	273	15/2013.07	162	16/1645.19	48	18/1442.08/5152	234	19/1943.28	88	36...		66/2119.62	28	A28242.18	312
15/1728.06	106	15/2013.22	162	16/1645.22	48	18/1532.07	105	19/1970.07	84	36/1901.18	30	6622	255	A28242.46	312
15/1728.07	106	15/2014.07	178	16/1704.02/9255	76	18/1533.07	104	19/2042.22	80	36/1901.22	30	6623	255	A28242.73	312
15/1732.07	100	15/2015.07	178	16/1704.02/9256	76	18/1807.06	130	19/2043.22	80	36/2002.04	16 / 19	68...		A28242.93	312
15/1732.22	100	15/2018.07	243	16/1704.02/9257	76	18/1807.07	130	19/2100.07	278	36/2104.06/5306	15	68/2029.04	230	A28342.07	310
15/1735.07/5239	121	15/2019.07	243	16/1704.19/9255	79	18/1812.04	206	19/2100.98	278	36/2104.22/5306	15	75...		A28342.46	310
15/1735.07/5240	121	15/2027.07	154	16/1704.19/9256	79	18/1812.22	206	25...		38...		75/2212.07	123	A28342.93	310
15/1735.07/5241	121	15/2027.22	154	16/1704.19/9257	79	18/1813.04	206	25/1563.07	102	38/1427.07	133	75/2212.22	123	A28442.07	314
15/1745.19/9258	75	15/2034.04	246	16/1722.26	42	18/1813.22	206	25/1665.07	102	38/1427.25	133	90...		A28442.18	314
15/1745.19/9259	75	15/2034.07	246	16/1847.04/9276	64	18/1814.04	206	25/1730.07	271 / 273	46...		9007	349	A28442.46	314
15/1745.19/9292	75	15/2034.22	246	16/1847.04/9283	64	18/1814.22	206	25/1730.18	271 / 273	46/1901.18	30	9018	349	A28442.73	314
15/1800.07/9277	70	15/2041.00	244	16/1847.04/9288	64	18/1815.04	211 / 212	25/1731.07	271 / 273	46/1901.22	30	9019	349	A28442.93	314
15/1800.07/9278	70	15/2042.22	81	16/1847.04/9289	64	18/1816.04	211 / 212	25/1731.18	271 / 273	48...		9024	349	A28612.07	291
15/1800.07/9281	70	15/2043.22	81	16/1847.04/9290	64	18/1817.04	211 / 212	25/1734.07	100	48/2029.04	230	9028	349	A28612.93	291
15/1804.07	146	15/2050.07-07/27	174	16/1904.02/9295	76	18/1825.04	203	25/1734.22	100	50...		9029	349	A28704.07	309
15/1804.10	146	15/2050.07-07/30	174	16/1904.02/9296	76	18/1825.22	200	25/1808.07	166	5017	141	9030	349	A28704.93	309
15/1805.07	146	15/2050.07-07/40	174	16/1904.02/9297	76	18/1826.04	203	25/1915.07	160	5019	141	9031	349	A28807.07	288
15/1805.10	146	15/2050.07-22/27	174	16/1904.19/9295	79	18/1826.22	200	25/1964.07	171	5056	141	9032	349	A28807.93	288
15/1806.07	159	15/2050.07-22/30	174	16/1904.19/9296	79	18/1827.04	203	25/1964.22	171	5057	141	9033	349	A28901.93	322
15/1808.07	166	15/2050.07-22/40	174	16/1904.19/9297	79	18/1827.22	200	25/1994.07	93	52...		9034	349	A29...	
15/1820.04	225	15/2060.07-07/27	174	16/2000.19/9324	69	18/1828.04	203	25/1994.09	93	5284	16	9035	349	A29412.93	347
15/1821.04	225	15/2060.07-07/30	174	16/2000.19/9325	69	18/1828.22	200	25/1994.22	93	5285	16	115...		A29912.93	347
15/1822.04	228	15/2060.07-07/40	174	16/2000.19/9326	69	18/1833.04	208	25/2000.07/9324	68	56...		115/2212.07	123	A39...	
15/1822.22	229	15/2060.07-22/27	174	16/2001.04	16 / 19	18/1834.04	208	25/2000.07/9325	68	56/2104.06/5306	15	115/2212.22	123	A39500.93	343
15/1823.04	228	15/2060.07-22/30	174	16/2007.22	34	18/1835.04	208	25/2000.07/9326	68	56/2104.22/5306	15	165...			
15/1823.22	229	15/2060.07-22/40	174	16/2101.18	46	18/1935.04	215	25/2080.07	168	60...		165/1903.07	124		
15/1900.07/9304	72	15/2061.07/27	174	16/2101.22	46	18/1936.04	215	25/2080.22	168	6000.07	272	165/1903.26	124		
15/1900.07/9305	72	15/2061.07/30	174	16/2104.06/5306	15	18/1947.07	139	25/2115.07	165	6000.18	272	A15...			
15/1900.07/9306	72	15/2061.07/40	174	16/2104.22/5306	15	18/2005.04	219	25/2115.22	165	6001.07	272	A152005.07	334		
15/1905.04	216	15/2080.07	168	16/2107.22/5300	22	18/2005.06	111 / 219	25/2117.62	27	6001.18	272	A152005.93	334		

Dimmsteuerung mit externen Dimmern

Sofern in unseren Produktbeschreibungen als „dimmbar“ gekennzeichnet, sind unsere LED-Leuchten zum Betrieb an externen LED-Dimmern geeignet.

Dimming by external dimmers

If specified in our product descriptions as „dimmable“ our LED-luminaires can be operated with external LED-dimmers.

Nachfolgende Tabelle zeigt die von uns getesteten Kombinationen unserer Leuchten und Dimmern eines ggf. vorhandenen Schalterprogramms. Bitte beachten Sie, dass evtl. durch den Betrieb an externen Dimmern auftretende Brummgeräusche nicht auszuschließen sind.

The list below shows you the result of the tested combinations of luminaires and possibly existing dimmers. Please kindly note that external dimmers may cause buzzing noise.

	Busch-Jäger		Gira		Jung		Vadsbo	
	Drehdimmer rotary dimmer 6523 UR-102	Tastdimmer touch dimmer 6526U	Drehdimmer rotary dimmer LED 2455 00	Tastdimmer touch dimmer LED 2385 00	Drehdimmer rotary dimmer 1731 DD	Tastdimmer touch dimmer 1710DE LED	Drehdimmer rotary dimmer VD300	Tastdimmer touch dimmer LD220
ADEO 18/1807	•	•	•	•	•	•	•	•
ALLY 15/1960								
BORA 16/1704, 16/1904			•	•	•		•	•
BORA 15/1745			•	•	•	•	•	•
CAS 15/2115			•	•	•	•	•	•
COR 18/2116			•	•	•	•	•	•
COSI 15/1905, 15/1906, 18/2005, 15/2105	•		•	•	•	•	•	•
COSI 15/1907			•	•	•	•	•	•
COSI 18/2006			•	•	•	•	•	•
DEX 18/2035	•	•	•	•	•	•	•	•
EIGHT 16/2214			•	•	•	•	•	•
ENIO 15/2215			•	•	•	•	•	•
ENIO 15/2216			•	•	•	•	•	•
FLUTE 16/2001	•		•	•	•	•	•	•
FLUTE 36/2002			•	•	•	•	•	•
GOTO 15/2013			•	•	•	•	•	•
GYRA 16/2127			•	•	•	•	•	•
IVA 15/2041	•	•	•	•	•	•	•	•
KAPO A18610	•		•	•	•	•	•	•
KARI 15/1945, 15/1946			•	•	•	•	•	•
KEA 26/2108	•	•	•	•	•	•	•	•
KEA 66/2108	•	•	•	•	•	•	•	•
LEXX 16/1504, 16/1644			•	•	•	•	•	•
LICA 15/2210	•		•	•	•	•	•	•
LICA 15/2211	•		•	•	•	•	•	•
LICA 15/1632			•	•	•	•	•	•
LIV 15/1732			•	•	•	•	•	•
LIV 25/1734, 26/1692, 26/1792			•	•	•	•	•	•
LIV 26/1892			•	•	•	•	•	•
LOMO 15/1800, 15/1900			•	•	•	•	•	•
LOMO-S 16/2000, 25/2000			•	•	•	•	•	•
LOOPY 16/2109			•	•	•	•	•	•
LUG 15/2014			•	•	•	•	•	•
LUG 15/2015			•	•	•	•	•	•
MÖWE 16/2101	•		•	•	•	•	•	•
MOYA 16/1722	•	•	•	•	•	•	•	•
NEX 16/2007			•	•	•	•	•	•
OKI A18803			•	•	•	•	•	•
OSO 15/1552, 15/1553, 15/2018, 15/2019	•		•	•	•	•	•	•
OZ A18815	•		•	•	•	•	•	•
PAIR 15/2027			•	•	•	•	•	•
PALA 15/1629			•	•	•	•	•	•
PAX 15/1808	•	•	•	•	•	•	•	•
PAX 25/1808	•	•	•	•	•	•	•	•
PIC 15/2050, 15/2060, 15/2061			•	•	•	•	•	•
POLE 36/1901, 46/1901			•	•	•	•	•	•
POLE 15/2080			•	•	•	•	•	•
PONT 25/2080			•	•	•	•	•	•
PONT 15/1954			•	•	•	•	•	•
RACK 15/1956	•		•	•	•	•	•	•
RACK 15/2254	•	•	•	•	•	•	•	•
REDO 25/2117			•	•	•	•	•	•
REDO 25/2118, 26/2118, 26/2119, 66/2119			•	•	•	•	•	•
RIWA 15/1806	•		•	•	•	•	•	•
RIWA 35/1806	•	•	•	•	•	•	•	•
RIWA 15/1964, 15/1965			•	•	•	•	•	•
ROTA 25/1964			•	•	•	•	•	•
ROTA 15/2164			•	•	•	•	•	•
SALLY 26/1641			•	•	•	•	•	•
SERVO 26/1893			•	•	•	•	•	•
SID 15/2034	•	•	•	•	•	•	•	•
SIMO 75/2212			•	•	•	•	•	•
SIMO 115/2212			•	•	•	•	•	•
SIRI44 A28242, A28342	•		•	•	•	•	•	•
SIRI44-L A28442	•	•	•	•	•	•	•	•
SKA 15/2012	•	•	•	•	•	•	•	•
SKIP A18805		•	•	•	•	•	•	•
SONA 15/1993			•	•	•	•	•	•
SONA 25/1994			•	•	•	•	•	•
STAY 165/1903			•	•	•	•	•	•
SWIFT A28704	•	•	•	•	•	•	•	•
TAIL 28/2114			•	•	•	•	•	•
WES 25/1563, 25/1665	•		•	•	•	•	•	•
YUMA 15/1440			•	•	•	•	•	•
YUMA 15/1441			•	•	•	•	•	•



Lichtsteuerung über Smartphone/Tablet-PC und Wandschalter

Alle mit diesem Symbol gekennzeichneten LED-Leuchten können optional mit einem CASAMBI Bluetooth-Modul ausgestattet werden. Die Leuchte kann dann mit der Casambi App für iOS und Android Geräte und/oder mit herkömmlichen Wandschaltern gesteuert werden. Die Casambi App ist kostenlos im Apple App Store und im Google Play Store erhältlich.

- Steuerung der Leuchte/n mit der App oder vorhandenem Wandschalter
- Dimmen der Leuchte/n
- Erstellen von Lichtszenen und Animationen
- Timerfunktion für zeitbasiertes an- und abschalten
- Netzwerkkonfiguration für mehrere Smartphones/Tablet-PC

Lighting control with smartphone/tablet-PC and wall switch

All luminaires marked with this icon can be equipped with an additional CASAMBI Bluetooth-dimmer. The Luminaire can be controlled with Casambi App for iOS and Android devices, as well as with standard wall switches. The Casambi App is available free of charge from Apple App Store and Google Play Store.

- lighting control with App or existing wall switch
- dimming of luminaire/s
- creating of lighting scenes and animations
- turn on and off with timer function
- network configuration for several smartphones/Tablet-PC

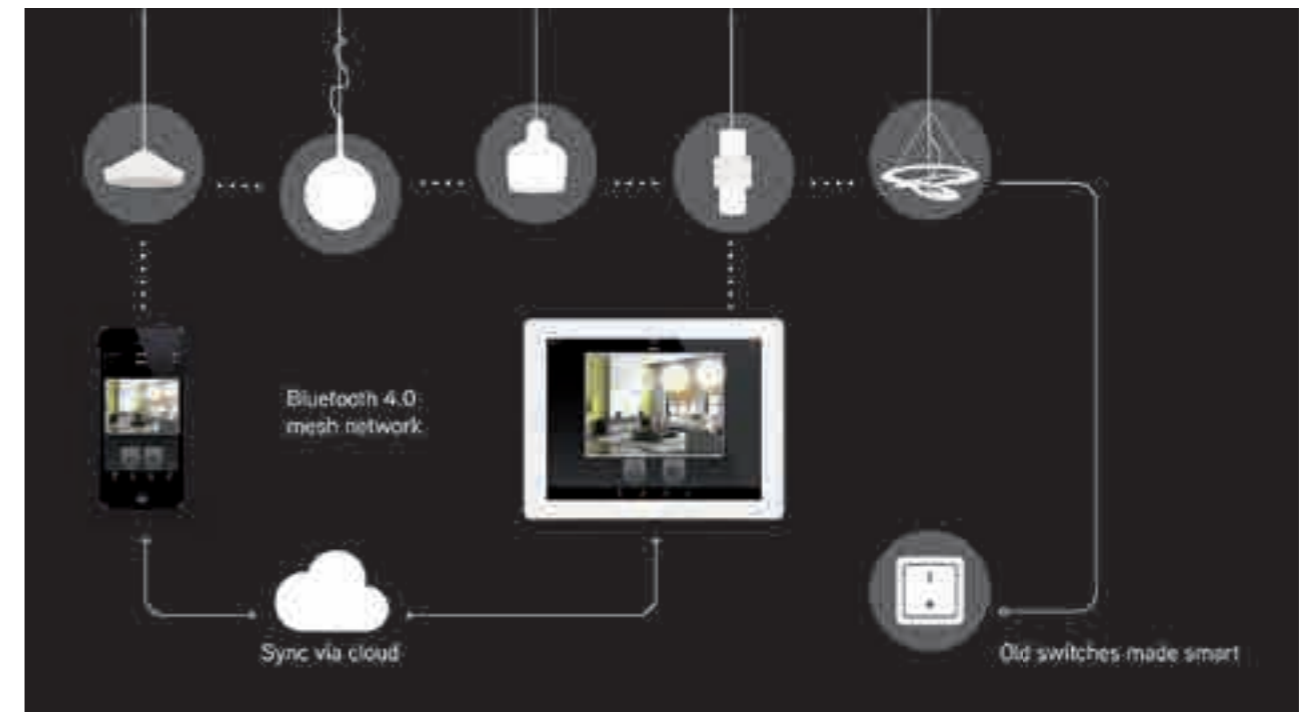

Bestellen Sie das Casambi Bluetooth-Modul gemeinsam mit der gewünschten Leuchte. Wir optimieren mittels Software das Dimmverhalten unserer Leuchten und liefern das Modul anschlussfertig in der Leuchte integriert.

Order the CASAMBI Bluetooth-dimmer together with desired luminaire. We optimize the dimming behaviour of our luminaires by software and supply the module integrated in the luminaire.

Art-Nr. 6100



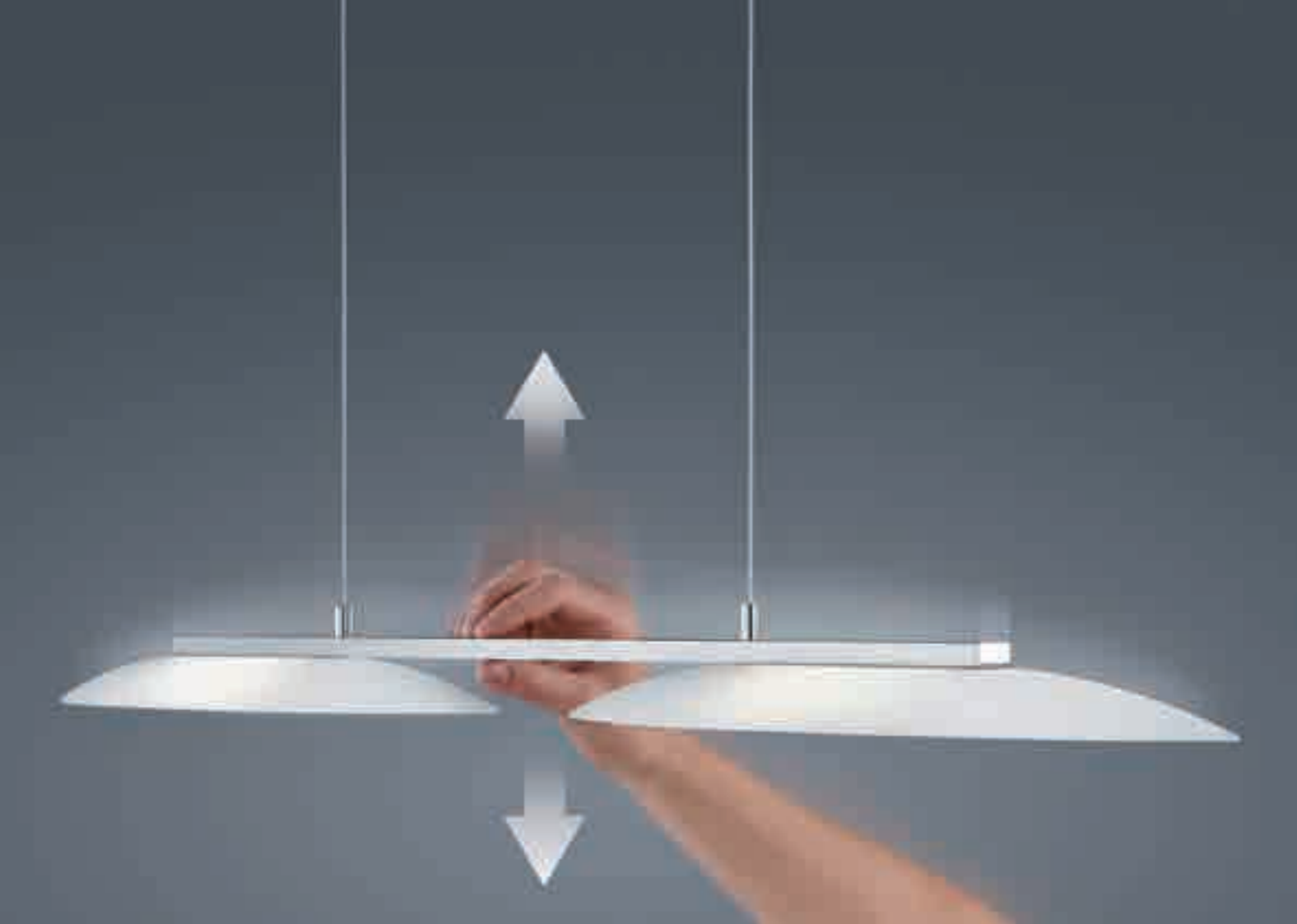

Die unsichtbare Höhenverstellung exklusiv von Helestra

- intuitives Verschieben der Leuchte auf gewünschte Höhe ohne Gegengewicht
- geeignet für unterschiedlichste Raumhöhen durch extra großen Verstellbereich von ca. 500-1700 mm
- kein Kürzen überstehender Leitungen bei niedrigen Raumhöhen durch automatische Kabelaufnahme im Gehäuse
- ideal an schrägen Decken durch unabhängige Verstellung beider Kabel
- einfache und schnelle Montage der Gehäuseabdeckung mit Magnetbefestigungen ohne sichtbaren Schrauben
- werkzeuglose Einstellung des Zugwiderstands



unsichtbar integriert im Deckengehäuse

invisibly integrated in ceiling housing

The invisible height adjustment exclusively by Helestra

- intuitive adjustment of desired height without counterweight
- suitable for various ceiling heights due to extra large adjustment range of about 500-1700 mm
- no shortening of unused cable at low ceilings – cables are stored in the housing
- ideal for sloped ceilings because of individual adjustment of cables
- quick and easy installation of housing cover with magnets. No visible screws
- tool-free adjustment of tensile strength

IP

Schutzzonen im Bad IP ratings and zones for bathrooms

Zone 0
≥ IPx7

Schutz gegen Untertauchen
Innenbereich Badewanne und Duschtasse
protection against immersion
inside bathtub or shower

Zone 1
≥ IPx5

Schutz gegen Strahlwasser
Senkrechte Flächen über Badewanne und
Duschtasse bis zu 2,25 m Höhe
protection against hose water
vertical surfaces above bathtub or shower
up to height of 2.25 m from the floor

Zone 2
≥ IPx4

Schutz gegen Spritzwasser
Bereich von 0,60 m um Zone 1
protection against splash water
0.60 m outside the perimeter of zone 1



Bitte beachten Sie:

Alle angegebenen Maße sind ca.-Abmessungen. Technische Änderungen behalten wir uns vor.

Bitte beachten Sie die der Leuchte beigefügten Gebrauchs- und Montageanleitungen.

Helestra Leuchtenmodelle sind als Geschmacksmuster geschützt, Nachahmungen werden gerichtlich verfolgt.

Das Eigentumsrecht dieses Kataloges behalten wir uns vor.

Es gelten grundsätzlich nur unsere Verkaufs- und Lieferbedingungen. Erfüllungsort und Gerichtsstand ist Dresden.

Please kindly note:

The measurement specifications refer to approximate dimensions. Technical details are subject to change.

Please pay attention to instructions of use and assembly provided with the luminaires.

Helestra products are protected by design registrations, imitations will be prosecuted.

We reserve ownership rights to this catalogue.

As a rule, only our sales and supply conditions apply. Place of delivery and jurisdiction is Dresden.



light+building
Frankfurt, Germany
13.03.2022 – 18.03.2022

Copyright

Helestra Leuchten GmbH
An den Breiten 7
D-01454 Leppersdorf
Tel. +49 (0) 35 28 / 43 83-0
Fax +49 (0) 35 28 / 43 83-44
www.helestra.de
info@helestra.de
USt.-Id: DE140207452
WEEE-Nr.: DE34965681
LUCID-Nr.: DE1937740317474

Fotografie
Photography
Klaus Stoll GmbH
D-59759 Arnsberg
Printed in Germany



Helestra Leuchten GmbH
An den Breiten 7
D-01454 Leppersdorf
Tel. +49 (0) 35 28 / 43 83-0
Fax +49 (0) 35 28 / 43 83-44
www.helestra.de
info@helestra.de



www.helestra.de