

**Light is pure magic.
Surreal atmospheres
are the true essence
of creation.
A light experience.**



Since 1974 has been synonymous with excellence in the crystal and glass industry. Originated from the consolidated experience of Isaac Glass, leading company in the production of components, Isaac Light is a lighting brand dedicated to the most prestigious interiors. Technique and technology are the means, design is the form and glass and crystal are the essence. Timeless materials that allow creativity and craft genius to overcome physical boundaries and experiment with light. A magical element open to the contamination of abstract and surreal evocative shapes that gives life to unique luminous frames. Isaac Light creates alchemical lighting experiences through the dialogue between materials and space.

Dal 1974 Isaac è sinonimo di eccellenza nel settore del vetro e cristallo. Dall'esperienza di Isaac Glass, azienda leader nella realizzazione della componentistica è nata Isaac Light, brand di illuminazione per gli interni più prestigiosi. Tecnica e tecnologia sono il mezzo, il design la forma, vetro e cristallo l'essenza. Dei materiali immortali che permettono alla creatività e al genio artigianale di superare i confini fisici e sperimentare con la luce. Elemento magico, che si lascia contaminare da forme evocative dall'aspetto astratto, surreale creando cornici luminose uniche. Isaac Light crea alchemiche esperienze di luce, facendo dialogare materia e spazio.

Contemporary



ERIS

A light that can turn spaces into enchanted places. Its aesthetic synthesis represents the essence of the project: a glass element is set onto metal as a gemstone.

08



KOOI new line

The perfect combination of rigor and decoration. Its schematic structure recalls the leafy branches of a tree on which little blown glass birds perch comfortably.

16



ODELLA

Geometric elements converse. A rigorous and clean structure simply embraces the light while discreetly and elegantly illuminating the space.

22



ORNUÈ

The antique technique of gold, copper and silver thread embroidery gave life to the new Ornué collection. The metal rod represents the thread and the glass is the canvas on which the designer embroidered his project. Elegant and precious, Ornué softly illuminates the space with refinement.

26

Neoclassic



ADAMAS

Countless crystals reflect the light into the space. Inspired by musical art, Adamas is an instrument in which every element is a note and part of a shining symphony. The amount of light projected on the kaleidoscopic components is adjustable and allows for limitless plays of reflection.

34



LILY

Luminous glass gems as if they were rubies. Clear glass drops reflect the light filtered by fabric lampshades.

38



MUSE

The magnificence of the structure recalls ancient Greek temples while the light points are a reference to the columns of a precious monument. Muse mightily stands at the center of the room, embellishing it and attracting the attention like a muse with his artist.

42





The collection



LED

ERIS
Design
Manuel Vivian

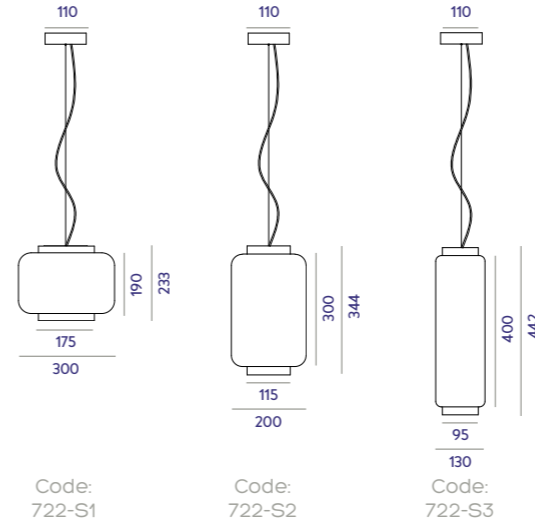

Code:
722-S1

Code:
722-S2

Code:
722-S3

Suspension Sospensione

Built-in LED version:
LED 17,5 / 4 W
2700 K 220-240 V
For U.S. market 110 V
Light bulb version:
1 x E27, LED or incandescent.
For U.S. market E26 light bulb

Versione led incorporato:
LED 17,5 / 4 W
2700 K 220-240 V
Per il mercato americano 110 V
Versione lampadina:
1 x E27, LED o incandescente
Per il mercato americano lampadina E26

Structure colors



Glass colors

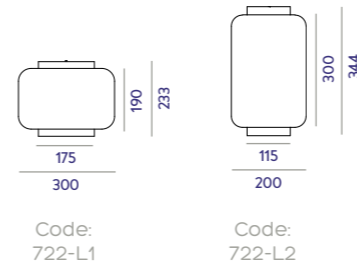

Code:
722-L1

Code:
722-L2

Table Tavolo

Built-in LED version:
LED 17,5 / 4 W
2700 K 220-240 V
For U.S. market 110 V
Light bulb version:
1 x E27, LED or incandescent.
For U.S. market E26 light bulb

Versione led incorporato:
LED 17,5 / 4 W
2700 K 220-240 V
Per il mercato americano 110 V
Versione lampadina:
1 x E27, LED o incandescente.
Per il mercato americano lampadina E26

Structure colors



Glass colors









KOOL new line 2017

Design
Manuel Vivian

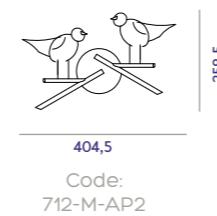
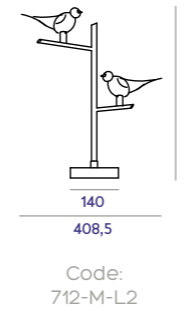
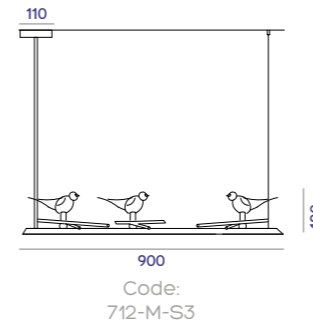

Suspension Sospensione

Light bulb version:
3 x G9 max.40 W or LED 220-240 V
For U.S. market 110 V

Versione lampadina:
3 x G9 max.40 W o LED 220-240 V
Per il mercato americano 110 V

Structure colors



Glass colors



Table Tavolo

Light bulb version:
2 x G9 max.40 W or LED 220-240 V
For U.S. market 110 V

Versione lampadina:
2 x G9 max.40 W o LED 220-240 V
Per il mercato americano 110 V

Structure colors



Glass colors



Applique Parete

Light bulb version:
2 x G9 max.40 W or LED 220-240 V
For U.S. market 110 V

Versione lampadina:
2 x G9 max.40 W o LED 220-240 V
Per il mercato americano 110 V

Structure colors



Glass colors



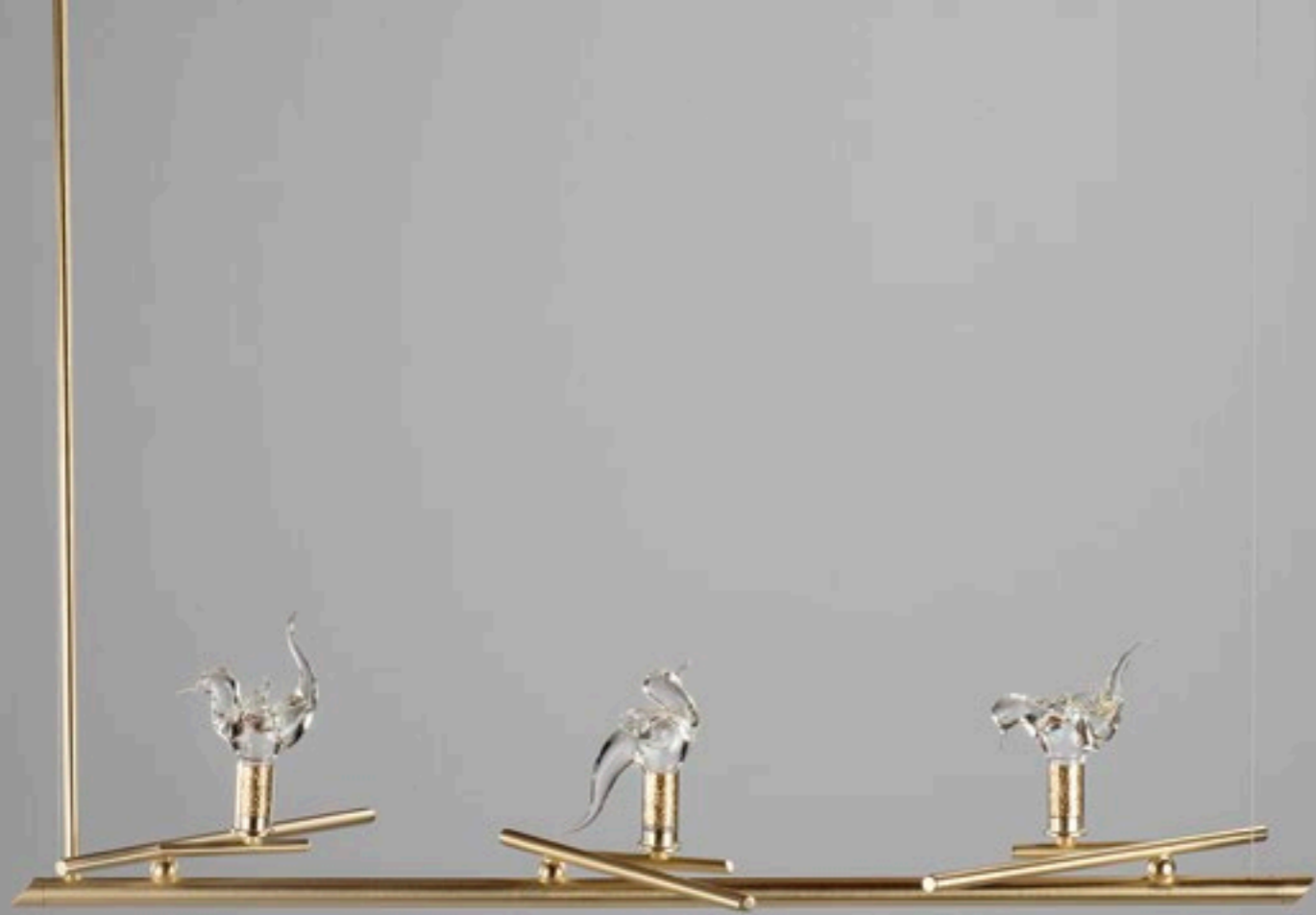



ODELLA

Design
IL Studio

LED

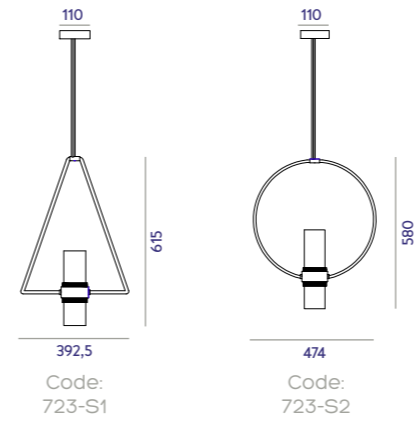

Suspension Sospensione

Built-in LED version:
LED: 2 x 3 W, 2700 K 220-240 V
For U.S. market 110 V
Light bulb version:
2 x G9, LED or halogen

Versione led incorporato:
LED: 2 x 3 W, 2700 K 220-240 V
Per il mercato americano 110 V
Versione lampadina:
2 x G9, LED o alogena

Structure colors



Glass colors





ORNÙÈ

Design
Manuel Barbieri | MM Company

LED

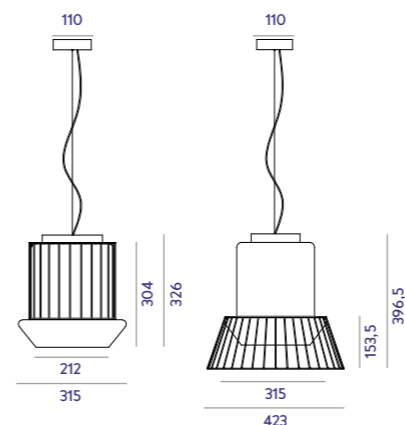

Code:
721-S1

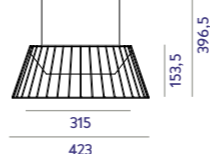

Code:
721-S1C

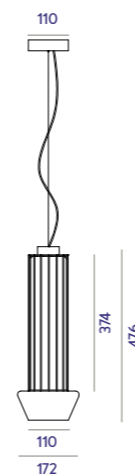

Code:
721-S2

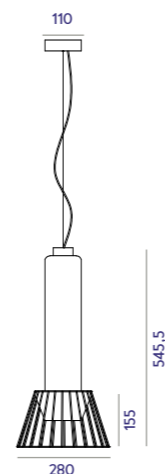

Code:
721-S2C

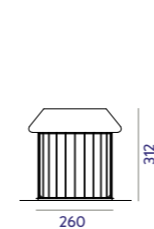

Code:
721-L1



Code:
721-L2

Suspension Sospensione

Built-in LED version:
LED 17,5 W, 2700 K 220-240 V.
For U.S. market 110 V
Light bulb version:
1 x E27, LED or incandescent.
For U.S. market E26 light bulb

Versione led incorporato:
LED 17,5 W, 2700 K 220-240 V.
Per il mercato americano 110 V
Versione lampadina:
1 x E27, LED o incandescente.
Per il mercato americano lampadina E26

Structure colors



Glass colors



Suspension Sospensione

Built-in LED version:
LED 4 W, 2700 K 220-240 V.
For U.S. market 110 V
Light bulb version:
1 x E27, LED or incandescent.
For U.S. market E26 light bulb

Versione led incorporato:
LED 4 W, 2700 K 220-240 V.
Per il mercato americano 110 V
Versione lampadina:
1 x E27, LED o incandescente.
Per il mercato americano lampadina E26

Structure colors



Glass colors



Table Tavolo

Built-in LED version:
LED 4 / 17,5 W, 2700 K 220-240 V.
For U.S. market 110 V
Light bulb version:
1 x E27, LED or incandescent.
For U.S. market E26 light bulb

Versione led incorporato:
LED 4 / 17,5 W, 2700 K 220-240 V.
Per il mercato americano 110 V
Versione lampadina:
1 x E27, LED o incandescente.
Per il mercato americano lampadina E26

Structure colors



Glass colors









LED

ADAMAS

Design
Manuel Vivian

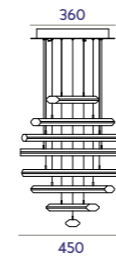
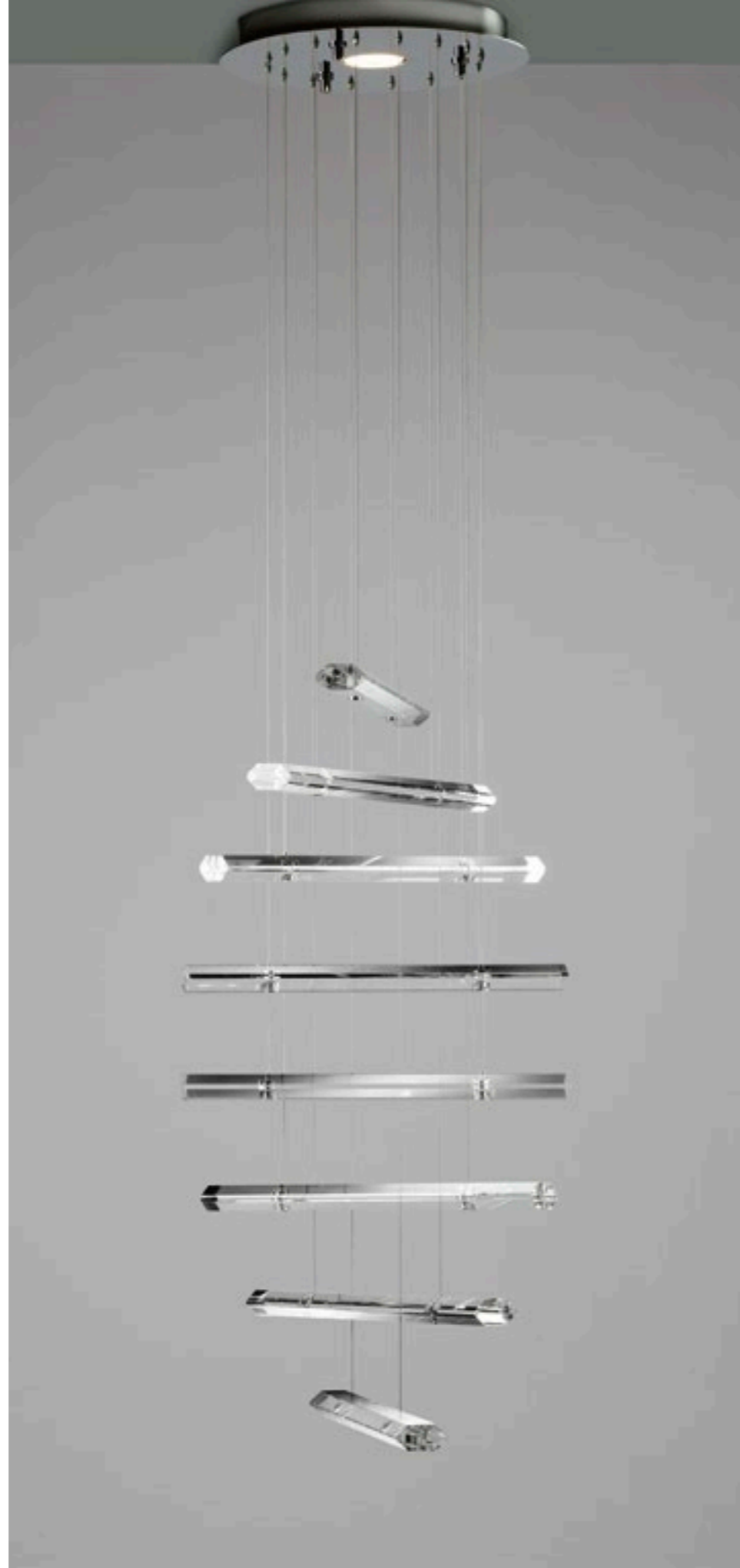

Code:
706-SP8

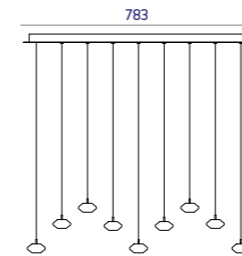

Code:
706-PP9

Suspension Sospensione

Built-in LED version:
LED: 17,5 / 8,7 W, 2700 K 220-240 V
For U.S. market 110 V
Light bulb version:
4 x GU10, LED or halogen.
Also available with glass bar L = 750 mm
(Code: .706-SG8) or in spiral versions
with 4 or 16 glass bars.

Versione led incorporato:
LED: 17,5 / 8,7 W, 2700 K 220-240 V
Per il mercato americano 110 V
Versione lampadina:
4 x GU10, LED o alogena.
Disponibile anche con barra in cristallo L=750 mm
(Code: .706-SG8) oppure nelle versioni a spirale
con n.4 o n.16 barre in cristallo.

Structure colors

C

Cristal colors

CT



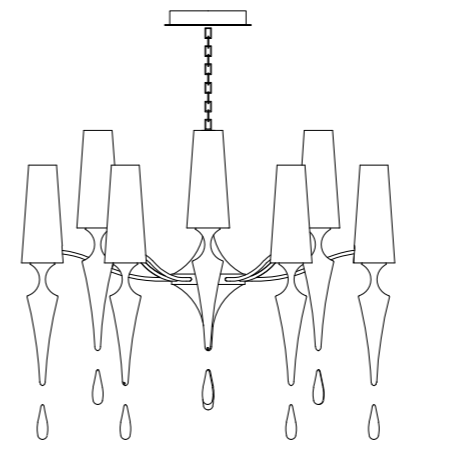

1070

Code:
719-12

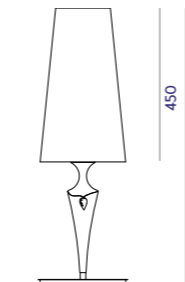

260

Code:
719-LG

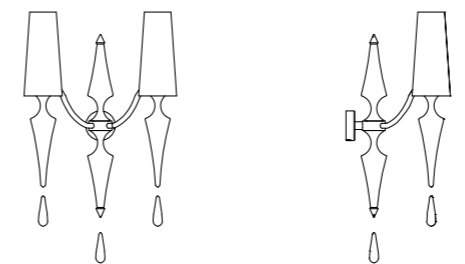

400,5

Code:
719-AP2

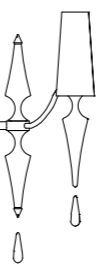

273,5

Suspension Sospensione

Light bulb version:
12 x E14 max.40 W or LED 220-240 V
For U.S. market 12 x E12, 110V

Versione lampadina:
12 x E14 max.40 W o LED 220-240 V
* per il mercato americano 12 x E12, 110V

Structure colors



Glass colors



Table Tavolo

Light bulb version:
1 x E27 max.60 W or LED 220-240 V
For U.S. market 1 x E26, 110V

Versione lampadina:
1 x E27 max.60 W o LED 220-240 V
* per il mercato americano 1 x E26, 110V

Structure colors



Glass colors



Applique Parete

Light bulb version:
2 x E14 max.40 W or LED 220-240 V
For U.S. market 2 x E12, 110V

Versione lampadina:
2 x E14 max.40 W o LED 220-240 V
* per il mercato americano 2 x E12, 110V

Structure colors



Glass colors





MUSE

Design
Andrea Bonini

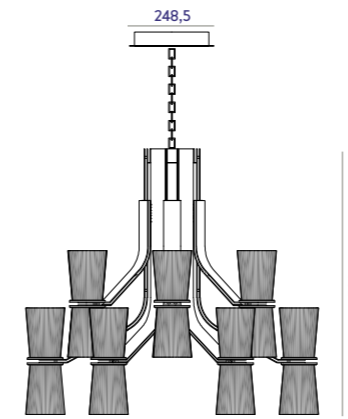

850
Code:
720-12

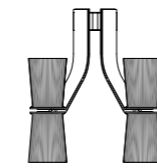

400
Code:
720-AP2

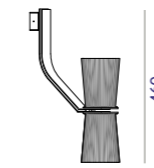

270
460

Suspension Sospensione

Light bulb version:
24 x E14 max.40 W or LED 220-240 V
For U.S. market 24 x E12, 110V

Versione lampadina:
24 x E14 max.40 W o LED 220-240 V
* per il mercato americano 24 x E12, 110V

Structure colors



Textile colors



Applique Parete

Light bulb version:
4 x E14 max.40 W or LED 220-240 V
For U.S. market 4 x E12, 110V

Versione lampadina:
4 x E14 max.40 W o LED 220-240 V
Per il mercato americano 4 x E12, 110V

Structure colors



Textile colors





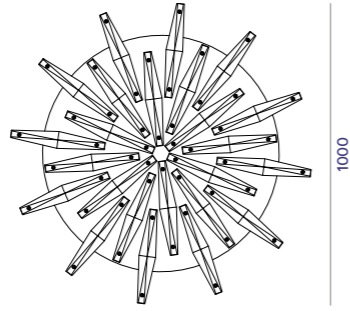
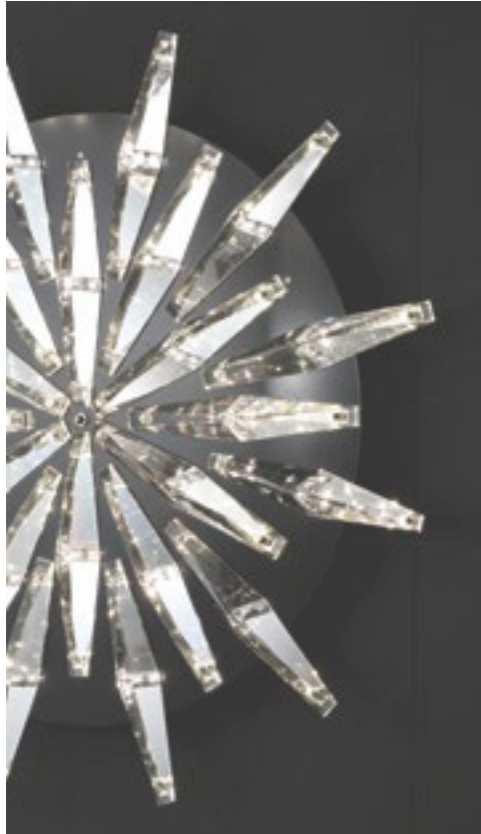

1000
Code:
703-APR24

HORTENSIA

Design by Manuel Vivian

Light bulb version:
24 x G4 max.2 W or LED 220-240 V, 12V
For U.S. market 110 V

Versione lampadina:
24 x G4 max.20 W o LED 220-240 V, 12 V
For U.S. market 110 V

Structure colors

C

Cristal colors

CT

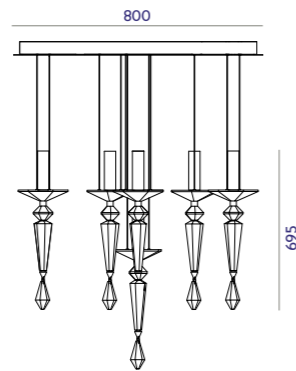

768
Code:
709-S10

INCOMPARABLE

Design by Manuel Vivian

Light bulb version:
10 x E14 max.40 W or LED 220-240 V
For U.S. market 10 x E12, 110V

Versione lampadina:
10 x E14 max.40 W o LED 220-240 V
Per il mercato americano 10 x E12, 110V

Structure colors

C

Cristal colors

CT

CN

CL

Technical details

Structure colors

- O Brushed brass | Ottone spazzolato
- OL Gloss brass | Ottone lucido
- A Black powder coated | Verniciatura nera a polvere
- NN Nickel black gloss | Nickel nero lucido
- R Gloss copper | Rame lucido
- C Gloss chrome | Cromo lucido

Glass colors

- T Transparent | Trasparente
- TR Transparent striped | Verniciatura nera a polvere
- TF Transparent fumé | Verniciatura nera a polvere
- B White | Bianco
- O Frosted | Satinato
- 1 Blu light fumé | Azzuro fumé
- 2 Peach pink | Rosa pesca
- 3 Grey blu fumé | Grigio blu fumé
- 4 Powder pink | Rosa cipria

Cristal colors

- CT Transparent | Trasparente
- CN Black | Nero
- CL Lilla | Lilla

Textile colors

- B White striped | bianco rigato

ISAACLIGHT

Via Carrozza 31 / Colognola ai Colli / 37030 / Verona / Italy
T +39 045 6151933
PIVA 01347820233
isaac@isaac.com / isaac.com / isaac.com

Creative Direction
MM Company / mmcompany.eu

Photo
Giampaolo Mascalzoni / newdeltaprint.it

Print
Inter Grafica Verona / intergraficavr.com

isaacelight.com

