

# LODES

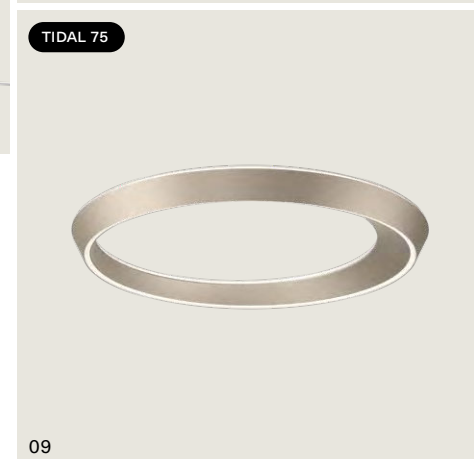

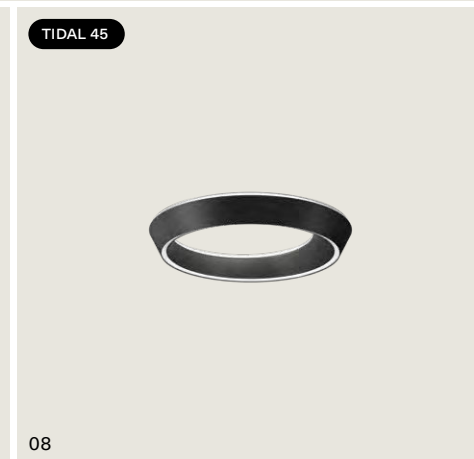

PART 1–New Concept: *Oblò design by Paola Navone – OTTO Studio, Random Stick design by Chia–Ying Lee.* PART 2–Family Extension: *Volum floor design by Snøhetta, Tidal 45 and 75 design by Needs Studio.*

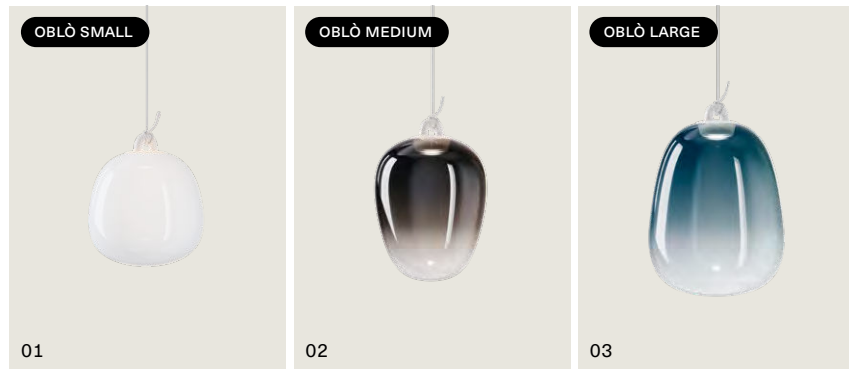

# ED. 2025 Lodes *Preview*

## PART 1—New Concept

01-03  
Oblò small,  
Oblò medium,  
Oblò large,  
*design by* Paola Navone – OTTO Studio  
Cluster suspension lamp 16

04,05  
Random Stick short,  
Random Stick long,  
*design by* Chia-Ying Lee  
Suspension lamp 30

## PART 2—Family Extension

06,07  
Volum short 29,  
Volum long 29,  
Volum short 42,  
Volum long 42,  
*design by* Snøhetta  
Floor lamp 50

08,09  
Tidal 45,  
Tidal 75,  
*design by* Needs Studio  
Ceiling lamp 60

## Paolo Navone – OTTO Studio

Architect, interior designer, product designer and art director, *Paola Navone's* approach is direct, visionary and eclectic with a passion for the flavours and colours of the much-loved and much-travelled southern hemisphere, alongside tastes and styles from the western world with its wealth of tradition, open mindedness and creative energy. All of which has meant a boundless curiosity, seeking out materials, forms and structures, from the present, past and future. Founder of OTTO, the Milan design studio she runs with *Gian Paolo Venier, Cristina Pettenuzzo* and *Domenico Diego*, she has curated a vast number of exhibitions worldwide and worked with top names in Italian and international design scene. A wide list of projects for hotels, restaurants and public spaces in South East Asia, the United States, Italy, France and around the world. The many international accolades received include the Osaka International Design Award, several Elle Deco International Design Awards for product design, the Red Dot Design Award and the Good Design Award, as well as a nomination for induction to the Design Hall of Fame received from Interior Design Magazine in New York.



Paola Navone

Schietta, sognatrice, eclettica: nella sua anima convivono sapori e colori del sud del mondo, conosciuto, amato, frequentato, unite al gusto e alle forme dell'Occidente ricco di tradizioni, aperto, in movimento. Da tutto ciò, la sua inesauribile curiosità alla ricerca di materie, forme e strutture, al presente, passato e futuro. *Paola Navone* è architetto e progettista di interni. Numerosi i progetti di hotel, ristoranti e spazi pubblici nel Sud Est Asiatico, negli Stati Uniti, in Italia, in Francia e in giro per il mondo. È designer di prodotti ed è art director. Moltissime le mostre e gli allestimenti curati in tutto il mondo. È la fondatrice di OTTO lo studio di progettazione milanese che, con *Gian Paolo Venier, Cristina Pettenuzzo* e *Domenico Diego*, collabora con le firme più importanti dello scenario internazionale ed italiano nel mondo del design. Numerosi i riconoscimenti ricevuti tra cui: l'International Design Award di Osaka, diversi Elle Deco International Design Awards, il Red Dot Design Award e il Good Design Award per il design di prodotti e la nomina a far parte della Hall of Fame del Design ricevuta da Interior Design Magazine a New York.





1-3 *Oblò* manufacturing process

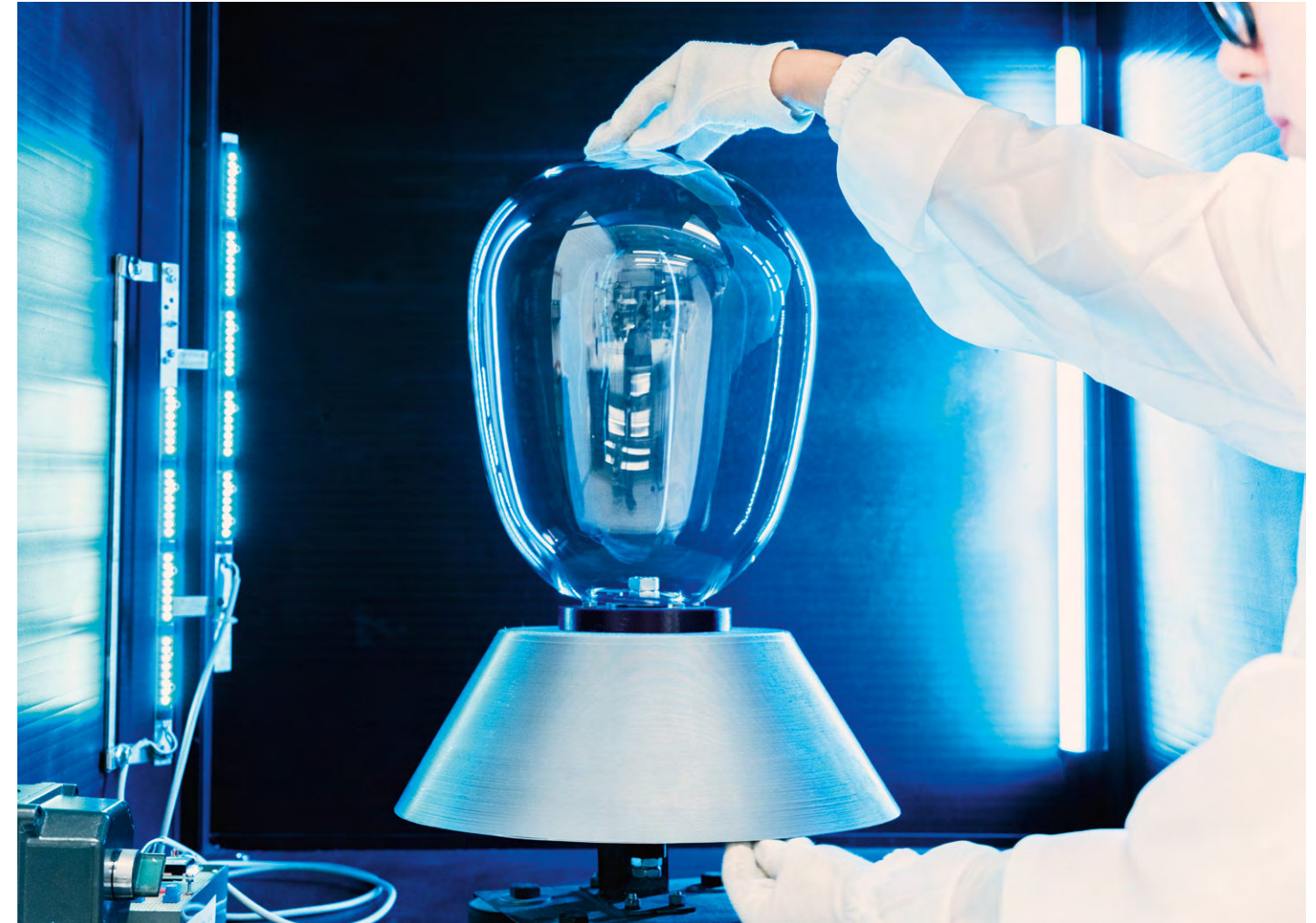
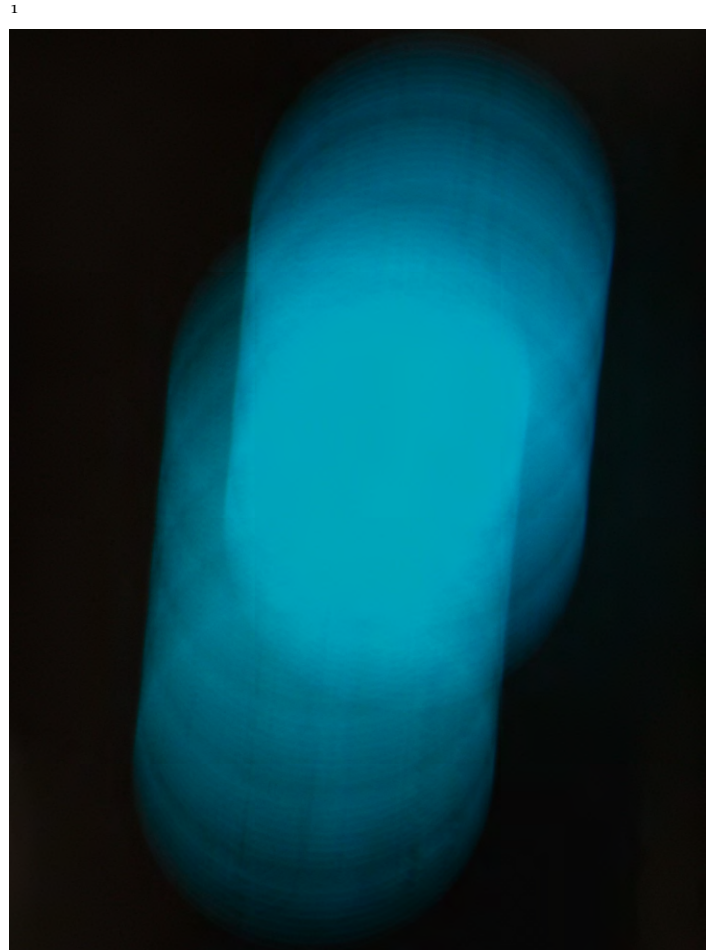









4

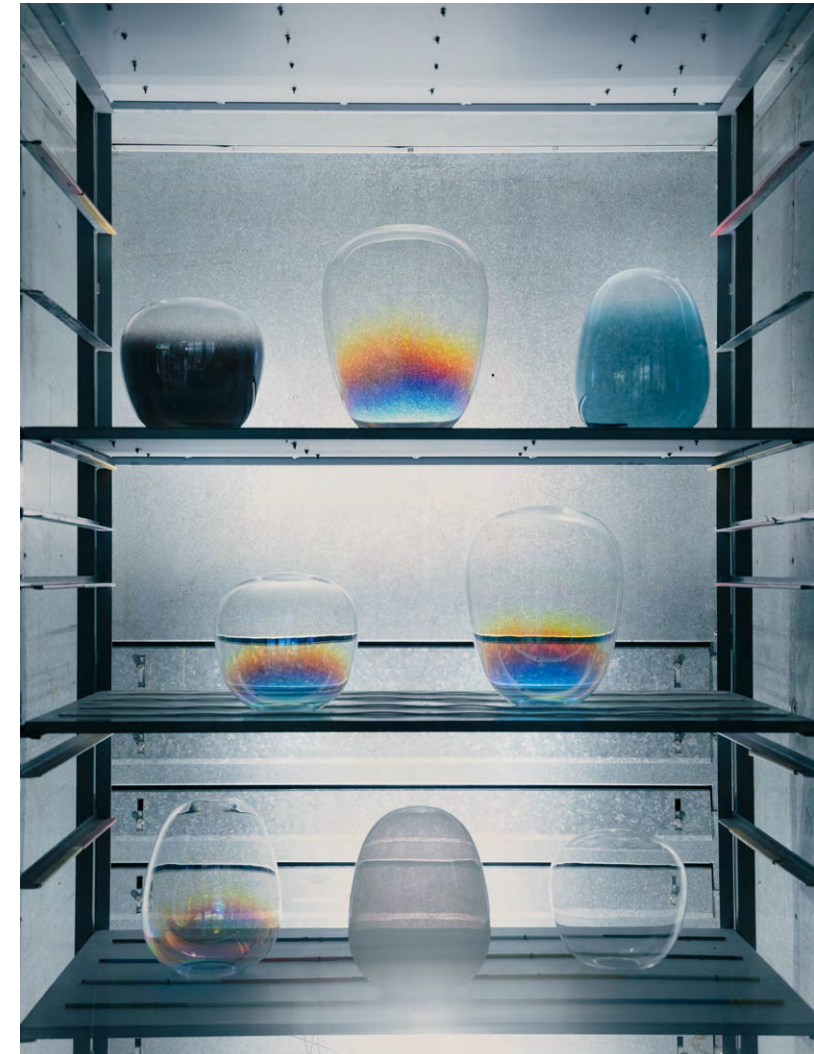

5

*Oblò* is a new lighting collection to evoke the sensations of the sea.





# *Lodes: New Concept*

Oblò, design by Paola Navone - OTTO Studio

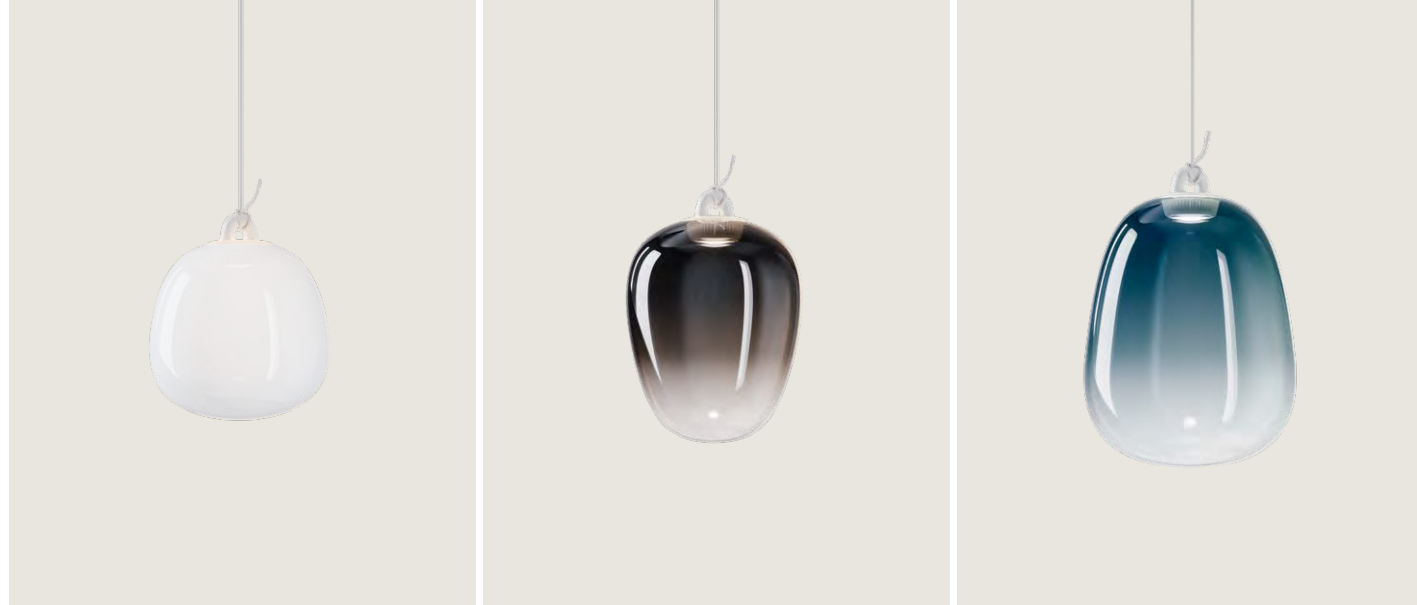

Small

Medium

Large

Random Stick, design by Chia-Ying Lee



Short

Long

## Oblò, design by Paola Navone – OTTO Studio, 2024

*Oblò* is a suspension lamp with a strong decorative character, offering fresh insights into the use of Pyrex in lighting while expanding *Lodes*' aesthetic vocabulary with the delicate sensitivity of Paola Navone – OTTO Studio. The product's soft silhouette and the five chosen shades for the finishes evoke marine imagery and reflections of light on water. The knotted canvas cable on the hook supporting the diffuser creates the illusion that the lamp floats in the air like a buoy. The LED light source and the electrical cable that powers it are concealed, making only the glass visible, just like looking through a porthole. Available in three gentle forms, *Oblò* offers lighting solutions capable of creating different movements and rhythms, alone or in compositions, to illuminate and decorate a wide range of spaces.

*Oblò* è una lampada a sospensione dal carattere fortemente decorativo che offre nuovi spunti sull'utilizzo del Pyrex nell'illuminazione e amplia il vocabolario estetico di *Lodes* con la delicata sensibilità di Paola Navone – OTTO Studio. La silhouette morbida del prodotto e le cinque sfumature scelte per le finiture evocano l'immaginario marino e i riflessi di luce sull'acqua, mentre il cavo telato annodato al gancio che sostiene il diffusore crea l'illusione che la lampada galleggi nell'aria come una boa. La sorgente luminosa LED è nascosta, così come il cavo elettrico che la alimenta: in questo modo si vede solo il vetro, proprio come guardando attraverso un oblò. Disponibile in tre forme dalle linee gentili, *Oblò* offre soluzioni di luce in grado di creare movimenti e ritmi diversi, da sola o in composizione, per illuminare e decorare una vasta gamma di ambienti.

● Spec sheet p. 28

| OBLÒ | CATEGORY LAMP      |                     | TYPE OF LIGHT  |              |
|------|--------------------|---------------------|----------------|--------------|
|      | Cluster suspension | Sospensione cluster | Diffused light | Luce diffusa |

NEW LAMP











Oblò small and large, FINISHES Azure Steel and Clear.



Cluster suspension lamp Oblò, FINISH Silk White.













*Oblò* est une suspension au caractère hautement décoratif qui propose de nouvelles idées sur l'utilisation du Pyrex dans l'éclairage et enrichit le vocabulaire esthétique de Lodes avec la délicate sensibilité de Paola Navone – OTTO Studio. La douce forme de cet article et les cinq nuances choisies pour les finitions évoquent l'imaginaire du monde marin et les reflets de la lumière sur l'eau, tandis que le câble en toile noué au crochet qui soutient le diffuseur crée l'illusion que la suspension flotte dans les airs comme une bouée sur l'eau. La source lumineuse LED est dissimulée, tout comme le câble électrique qui l'alimente : ainsi, seul le verre est visible, comme s'il l'on regardait à travers un hublot. Disponible en trois formes aux lignes douces, *Oblò* propose des solutions d'éclairage en mesure de créer différents mouvements et rythmes, seule ou en composition, pour illuminer et décorer une vaste gamme d'ambiances. ● FR

*Oblò* ist eine Hängeleuchte mit stark dekorativem Charakter, die neue Einblicke in die Verwendung von Pyrex in der Beleuchtung bietet und das ästhetische Vokabular von Lodes mit der feinen Sensibilität von Paola Navone – OTTO Studio – erweitert. Die weiche Silhouette des Produkts und die fünf für die Ausführungen gewählten Farbtöne, erwecken Vorstellungen von Meeresmotiven und Lichtreflexen auf dem Wasser, während das geknotete Segeltuchkabel am Haken, der den Diffusor trägt, die Illusion erzeugt, dass die Leuchte wie eine Boje in der Luft schwebt. Das LED-Leuchtmittel ist verdeckt, ebenso wie das zugehörige Stromkabel: auf diese Weise ist nur das Glas zu sehen, genauso wie beim Blick durch ein Bullauge. *Oblò* ist in drei Formen mit sanften Linien erhältlich und bietet Beleuchtungslösungen, die in der Lage sind, einzeln oder in Komposition verschiedene Bewegungen und Rhythmen zu erzeugen, um eine Vielzahl von Ambiente zu beleuchten und zu dekorieren. ● DE

*Oblò* es una lámpara de suspensión con un gran carácter decorativo que ofrece nuevas ideas acerca de la utilización del Pyrex en la iluminación y amplía el vocabulario estético de Lodes con la delicada sensibilidad de Paola Navone – OTTO Studio. La suave silueta del producto y los cinco tonos elegidos para los acabados evocan el imaginario marino y los reflejos de luz sobre el agua, mientras el cable revestido de tela anudado en el gancho que sostiene el difusor hace creer que la lámpara flote en el aire como una boya. La fuente luminosa LED está oculta, del mismo modo que el cable eléctrico que la alimenta: de esta forma sólo se ve el vidrio, del mismo modo que cuando se mira a través de una claraboya. Disponible en tres formas de líneas suaves, *Oblò* ofrece soluciones de luz capaces de crear movimientos y ritmos distintos, por sí sola o como parte de una composición, para iluminar y decorar una amplia gama de ambientes. ● ES

*Oblò* – это подвесной светильник с выраженным декоративным характером, предлагающий новые идеи для применения стекла Pyrex в освещении и расширяющий эстетическую гамму Lodes тонкой чувствительностью Паолы Навоне – OTTO Studio. Мягкий силуэт светильника и выбранные для отделки пять оттенков навевают морские образы и отражения света на воде, а обтянутый тканью трос, завязанный на крюке, поддерживающем диффузор, создает иллюзию, будто светильник парит в воздухе, как буй. Светодиодный источник света скрыт, как и питающий его электрический кабель: таким образом видно только стекло, как если бы вы смотрели в иллюминатор. Светильник *Oblò*, доступный в трех формах, отличающихся плавными линиями, предлагает световые решения, способные создавать различные движения и ритмы, по-отдельности или в композиции, освещая и украшая самые разнообразные помещения. ● RU

*Oblò* 是一款具有高度装饰性的悬吊灯,它为派热克斯玻璃在照明中的使用提供了新的见解并通过OTTO工作室的 Paola Navone那细腻敏感度而扩展了Lodes的审美词汇。这款产品的柔和轮廓和饰面的五种精选调色板让人忆起海洋的画面以及水面上的光线反射,而打结在挂钩上用来支撑灯罩的帆布缆绳则营造出灯件如同浮标一般漂浮在空中的错觉。LED光源和为其供电的线缆都是隐匿的:如此一来我们只能看到玻璃,就像透过舷窗观望一般。共有三种线条柔和的可选形状,*Oblò*提供能够以单独或组合方式创造不同运动和节奏的灯光解决方案,以照亮并装饰各种环境。● ZH

Oblò small › Cluster suspension lamp **NEW LAMP**

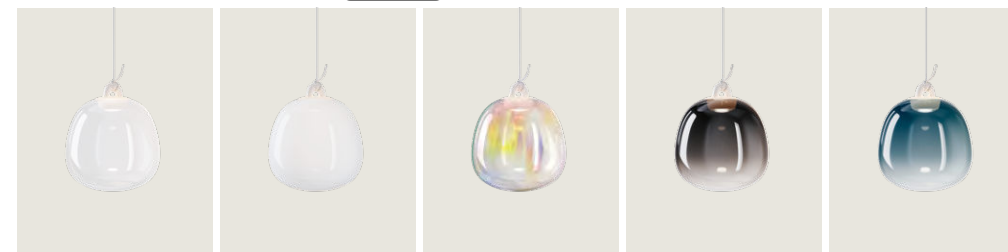

Oblò medium › Cluster suspension lamp **NEW LAMP**

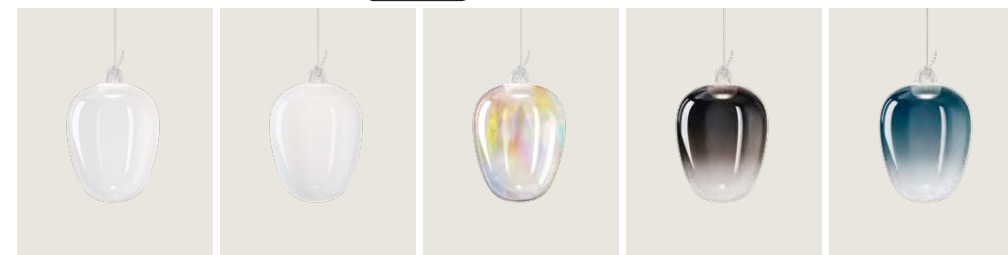

Oblò large › Cluster suspension lamp **NEW LAMP**

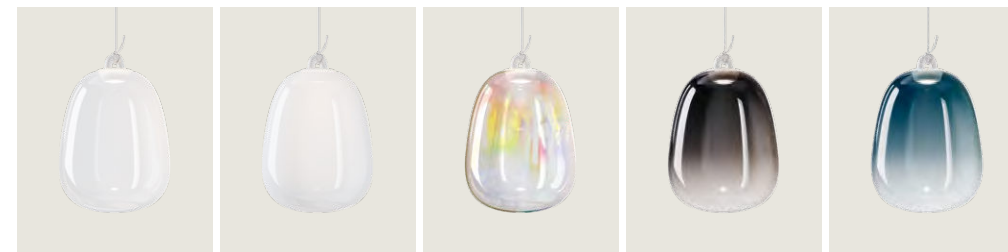

Oblò small NEW

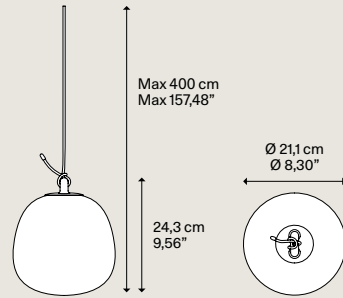

|  |                 |
|--|-----------------|
| <b>Silicone hook</b><br>Gancio in silicone   | White<br>Bianco |
| White fabric cable<br>Cavo bianco in tessuto |                 |

|  |                |   |                |   |
|--|----------------|---|----------------|---|
| <b>Blown glass diffuser</b><br>Diffusore in vetro soffiato | Code<br>Codice | A | Code<br>Codice | B |
| Clear<br>Trasparente                                       | 21811 0027     |   | 21811 0030     |   |
| Silk White<br>Bianco Seta                                  | 21811 1327     |   | 21811 1330     |   |
| Rainbow<br>Iridescente                                     | 21811 0127     |   | 21811 0130     |   |
| Glossy Smoke<br>Fumo Lucido                                | 21811 4327     |   | 21811 4330     |   |
| Azure Steel<br>Azzurro Metallizzato                        | 21811 8627     |   | 21811 8630     |   |

|   |    |
|---|----|
| <b>Light source</b><br>Sorgente luminosa        | A  |
| LED   |    |
| 2700  | K  |
| 11  | W  |
| 1280  | lm |
| 220-240   | V  |
| CRI 90  |    |
| MacAdam 3-Step                                  |    |
| LED and driver included<br>LED e driver inclusi |    |

|   |    |
|---|----|
| <b>Light source</b><br>Sorgente luminosa        | B  |
| LED   |    |
| 3000  | K  |
| 11  | W  |
| 1300  | lm |
| 220-240   | V  |
| CRI 90  |    |
| MacAdam 3-Step                                  |    |
| LED and driver included<br>LED e driver inclusi |    |

Net weight 0,64 kg / 1,41 lbs | Pack Colli 2 | Energy class Classe energetica D



Oblò large NEW

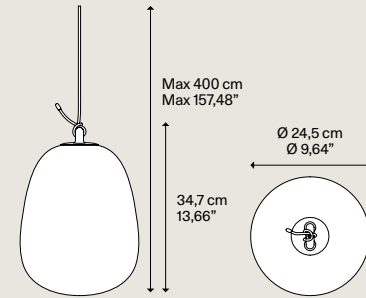

|  |                 |
|--|-----------------|
| <b>Silicone hook</b><br>Gancio in silicone   | White<br>Bianco |
| White fabric cable<br>Cavo bianco in tessuto |                 |

|  |                |   |                |   |
|--|----------------|---|----------------|---|
| <b>Blown glass diffuser</b><br>Diffusore in vetro soffiato | Code<br>Codice | A | Code<br>Codice | B |
| Clear<br>Trasparente                                       | 21813 0027     |   | 21813 0030     |   |
| Silk White<br>Bianco Seta                                  | 21813 1327     |   | 21813 1330     |   |
| Rainbow<br>Iridescente                                     | 21813 0127     |   | 21813 0130     |   |
| Glossy Smoke<br>Fumo Lucido                                | 21813 4327     |   | 21813 4330     |   |
| Azure Steel<br>Azzurro Metallizzato                        | 21813 8627     |   | 21813 8630     |   |

|   |    |
|---|----|
| <b>Light source</b><br>Sorgente luminosa        | A  |
| LED   |    |
| 2700  | K  |
| 11  | W  |
| 1280  | lm |
| 220-240   | V  |
| CRI 90  |    |
| MacAdam 3-Step                                  |    |
| LED and driver included<br>LED e driver inclusi |    |

|   |    |
|---|----|
| <b>Light source</b><br>Sorgente luminosa        | B  |
| LED   |    |
| 3000  | K  |
| 11  | W  |
| 1300  | lm |
| 220-240   | V  |
| CRI 90  |    |
| MacAdam 3-Step                                  |    |
| LED and driver included<br>LED e driver inclusi |    |

Net weight 0,82 kg / 1,80 lbs | Pack Colli 2 | Energy class Classe energetica D



Oblò medium NEW

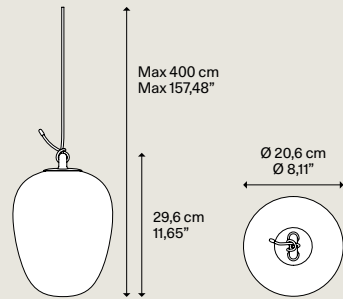

|  |                 |
|--|-----------------|
| <b>Silicone hook</b><br>Gancio in silicone   | White<br>Bianco |
| White fabric cable<br>Cavo bianco in tessuto |                 |

|  |                |   |                |   |
|--|----------------|---|----------------|---|
| <b>Blown glass diffuser</b><br>Diffusore in vetro soffiato | Code<br>Codice | A | Code<br>Codice | B |
| Clear<br>Trasparente                                       | 21812 0027     |   | 21812 0030     |   |
| Silk White<br>Bianco Seta                                  | 21812 1327     |   | 21812 1330     |   |
| Rainbow<br>Iridescente                                     | 21812 0127     |   | 21812 0130     |   |
| Glossy Smoke<br>Fumo Lucido                                | 21812 4327     |   | 21812 4330     |   |
| Azure Steel<br>Azzurro Metallizzato                        | 21812 8627     |   | 21812 8630     |   |

|   |    |
|---|----|
| <b>Light source</b><br>Sorgente luminosa        | A  |
| LED   |    |
| 2700  | K  |
| 11  | W  |
| 1280  | lm |
| 220-240   | V  |
| CRI 90  |    |
| MacAdam 3-Step                                  |    |
| LED and driver included<br>LED e driver inclusi |    |

|   |    |
|---|----|
| <b>Light source</b><br>Sorgente luminosa        | B  |
| LED   |    |
| 3000  | K  |
| 11  | W  |
| 1300  | lm |
| 220-240   | V  |
| CRI 90  |    |
| MacAdam 3-Step                                  |    |
| LED and driver included<br>LED e driver inclusi |    |

Net weight 0,69 kg / 1,52 lbs | Pack Colli 2 | Energy class Classe energetica D



Suspension lamps must be installed on a canopy  
Le lampade a sospensione devono essere installate su rosone



Suspension lamps must be installed on a canopy  
Le lampade a sospensione devono essere installate su rosone





## Random Stick, *design by Chia-Ying Lee, 2024*

*Random Stick* extends the collection of the same name designed by Chia-Ying Lee with a stand-alone suspension lamp that has an essential yet highly decorative character. *Random's* poetic spheres of light find their place on a hexagonal bar, reminiscent of fragile soap bubbles skimming the surface before taking flight again. The lamp, available in two bar lengths – 100 cm and 150 cm – lends itself to illuminating long, rectangular surfaces of various sizes, such as a dining table or a cocktail bar counter. The spheres pick up on *Random's* seven finishes, freely combinable on polished gold, polished black, and matt white bars to create original colour combinations and luminous effects. The decorative function of the spheres is further enhanced by LED modules at the bottom of the bar, complementing the light already diffused by the spheres and ensuring uniform downward brightness.

*Random Stick* amplia l'omonima collezione firmata da Chia-Ying Lee con una lampada a sospensione stand-alone dal carattere essenziale, ma fortemente decorativo. Le poetiche sfere di luce di *Random* trovano posto su una barra esagonale, quasi come fossero fragili bolle di sapone che ne sfiorano la superficie prima di riprendere il volo. La lampada, disponibile in due lunghezze di barra, da 100 cm e 150 cm, si presta a illuminare superfici lunghe e rettangolari di diverse dimensioni, come un tavolo da pranzo o il bancone di un cocktail bar. Le sfere riprendono le sette finiture di *Random*, liberamente abbinabili su barre di colore oro lucido, nero lucido e bianco opaco per creare originali accostamenti cromatici ed effetti luminosi. La funzione decorativa delle sfere viene ulteriormente accentuata grazie ai moduli LED nella parte inferiore della barra: ciò completa la luce già diffusa dalle sfere e garantisce una luminosità uniforme verso il basso.

● Spec sheet p. 42

| RANDOM STICK | CATEGORY LAMP |             | TYPE OF LIGHT                                |   |
|--------------|---------------|-------------|--|---|
|              | Suspension    | Sospensione | Symmetrical diffused light<br>Diffused light | Luce simmetrica diffusa<br>Luce diffusa |

NEW LAMP

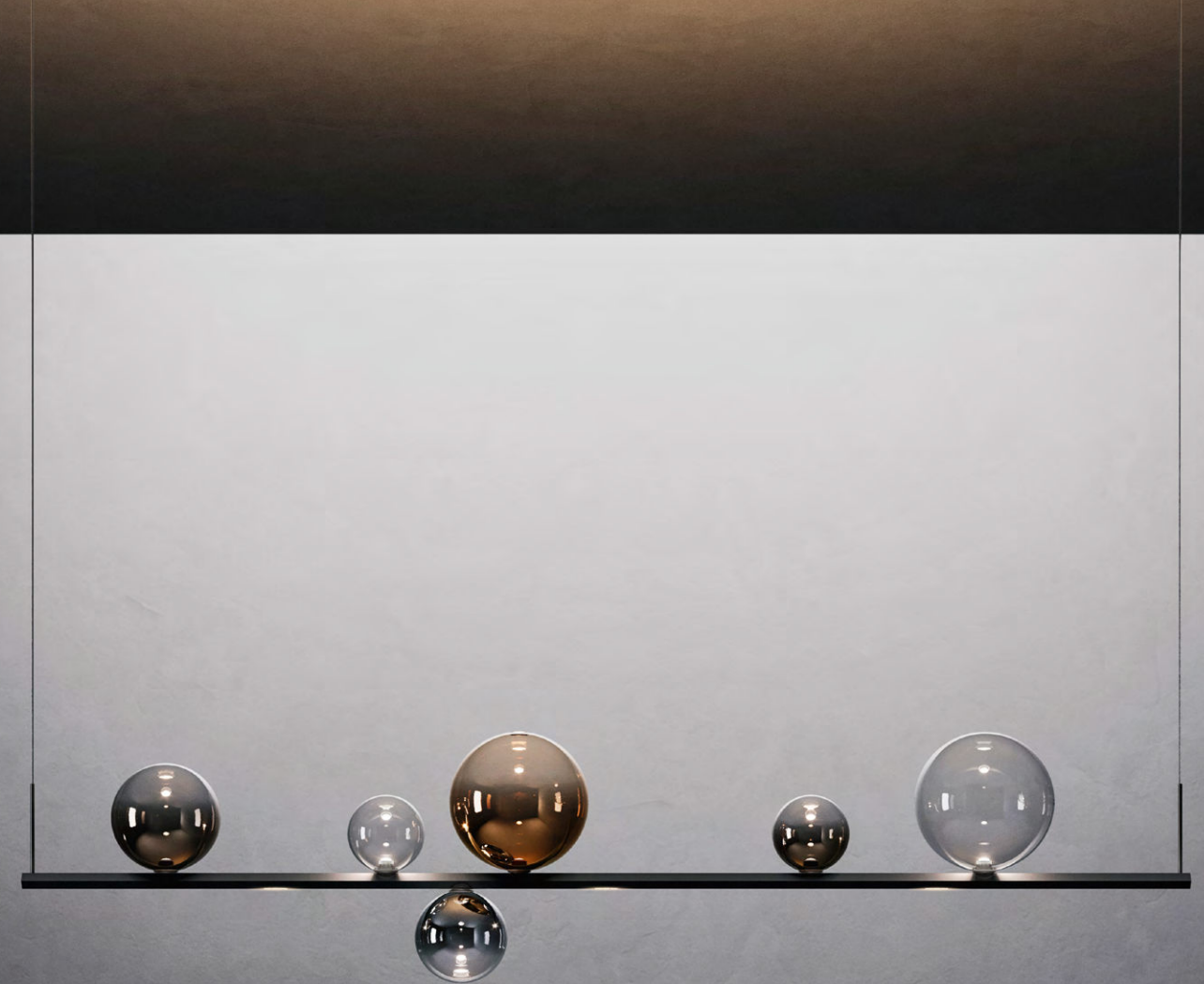

















Random Stick, FINISHES Frosted White and Chrome – Structure Black Chrome.



1



2

1 Random Stick short, FINISHES Glossy Smoke, Clear and Chrome – Structure Glossy Gold.  
2 Random Stick, FINISH Glossy Smoke – Structure Extra Matte White.

*Random Stick* élargit la collection du même nom conçue par Chia-Ying Lee avec une suspension stand-alone au caractère essentiel mais fortement décoratif. Les sphères de lumière poétiques de *Random* reposent sur une barre hexagonale, faisant penser à de fragiles bulles de savon qui effleurent la surface avant de s'envoler. La suspension, disponible en deux longueurs de barre de 100 cm et 150 cm, éclaire des surfaces longues et rectangulaires de différentes tailles, comme une table à manger ou le comptoir d'un cocktail bar. Les sphères rappellent les sept finitions de *Random*, à combiner librement sur des barres de couleur or brillant, noir brillant et blanc mat pour créer d'originales combinaisons de couleurs et d'effets de lumière. La fonction décorative des sphères est encore plus accentuée grâce aux modules LED installés dans la partie inférieure de la barre : ils complètent la lumière déjà diffusée par les sphères et garantissent une luminosité uniforme vers le bas. ●FR

*Random Stick* erweitert die von Chia-Ying Lee entworfene gleichnamige Kollektion um eine eigenständige Hängeleuchte mit essentiellen, aber sehr dekorativem Charakter. Die poetischen Lichtkugeln von *Random* finden ihren Platz auf einem sechseckigen Stab, als wären sie zerbrechliche Seifenblasen, die die Oberfläche kurz berühren, um anschließend wieder in die Luft aufzusteigen. Die Leuchte, die in zwei Stablängen – 100 cm und 150 cm – erhältlich ist, eignet sich zur Beleuchtung von langen, rechteckigen Flächen unterschiedlicher Größe, wie z. B. einem Esstisch oder einer Cocktailbar-Theke. Die Kugeln greifen die sieben Ausführungen von *Random* auf, die auf glänzend goldenen, glänzend schwarzen und mattweißen Stäben frei kombiniert werden können, um originelle Farbkombinationen und leuchtende Effekte zu erzielen. Die dekorative Funktion der Kugeln wird durch die LED-Module am unteren Ende des Stabes noch verstärkt: dies ergänzt das bereits von den Kugeln verbreitete Licht und sorgt für eine gleichmäßige Leuchtkraft nach unten. ●DE

*Random Stick* amplía la colección del mismo nombre firmada por Chia-Ying Lee con una lámpara de suspensión stand alone con un carácter esencial y muy decorativo. Las poéticas esferas de luz de *Random* tienen cabida en una barra hexagonal, prácticamente como si fueran frágiles pompas de jabón que rozan la superficie antes de reanudar el vuelo. La lámpara, disponible con la barra de dos longitudes distintas – de 100 cm y 150 cm, se presta a iluminar superficies largas y rectangulares de distintos tamaños, como una mesa de comedor o la barra de una coctelería. Las esferas retoman los siete acabados de *Random* que pueden combinarse libremente en barras de color dorado brillante, negro brillante y blanco mate para crear originales combinaciones cromáticas y efectos de iluminación. La función decorativa de las esferas la acentúan aún más los módulos LED de la parte inferior de la barra: esto completa la luz que ya proyectan las esferas y garantiza una luminosidad uniforme hacia abajo. ●ES

*Random Stick* расширяет одноименную коллекцию, разработанную Chia-Ин Ли, отдельным подвесным светильником, обладающим простотой, и, одновременно, выраженной декоративностью. Поэтические световые сферы *Random* крепятся на шестигранный стержень, как хрупкие мыльные пузыри, легко дотрагивающиеся до поверхности перед тем, как улететь в небо. Лампа, выпускаемая с двумя вариантами длины стержня, 100 см и 150 см, подходит для освещения длинных и прямоугольных поверхностей разных размеров, таких как обеденный стол или стойка коктейль-бара. Сферы повторяют семь вариантов отделки *Random*, которые можно свободно сочетать на блестящих золотых, блестящих черных и матовых белых стержнях для создания оригинальных хроматических сочетаний и световых эффектов. Декоративная функция сфер дополнительно подчеркивается светодиодными модулями в нижней части стержня: они дополняют свет, рассеиваемый сферами, и гарантируют равномерную яркость излучения в направлении вниз. ●RU

*Random Stick* 以一款特征朴素但具有高度装饰性的独立悬吊灯扩展了由李佳颖设计的同名系列。Random那富有诗意的灯球位于一条六角形条杆上,几乎就像脆弱的肥皂泡一样于再次飞起之前掠过表面。这款灯品提供100厘米和150厘米这两种可选长度,适合照亮不同尺寸的长形和矩形表面,例如餐桌或鸡尾酒吧的吧台。球体再现Random的七种饰面,可在亮金色、亮黑色和哑光白色条杆上自由搭配,以创建原创性的色彩组合和灯光效果。条杆下部的LED模块进一步彰显了球体的装饰功能:这补充了已由球体扩散的光线且保证了朝向下方的均匀亮度。●ZH

Random Stick short » Suspension lamp NEW LAMP

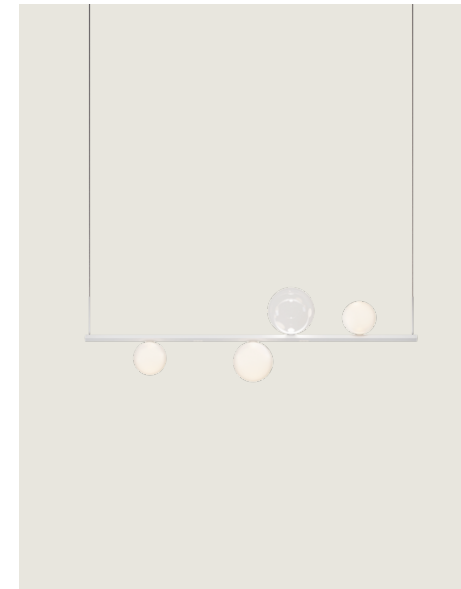

Examples of composition / Esempi di composizione

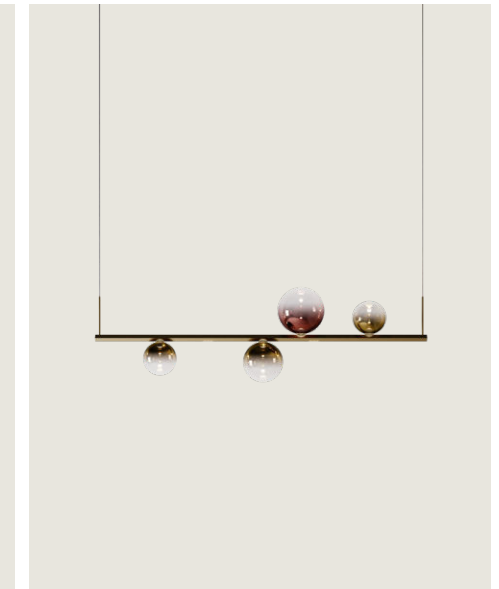
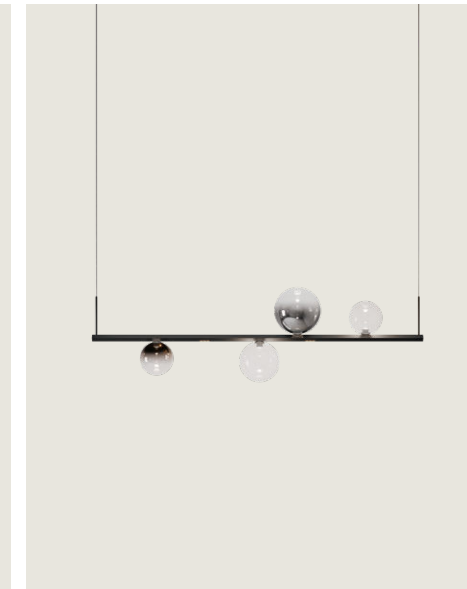

Random Stick long » Suspension lamp NEW LAMP

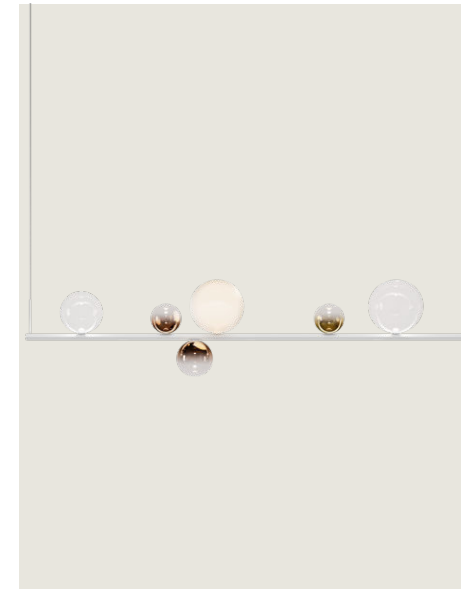

Examples of composition / Esempi di composizione

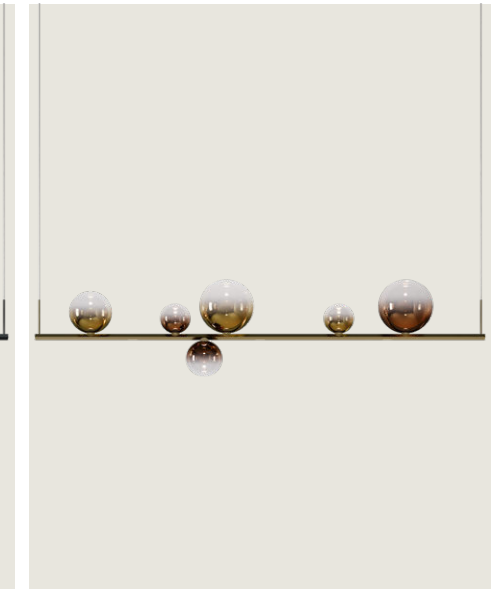
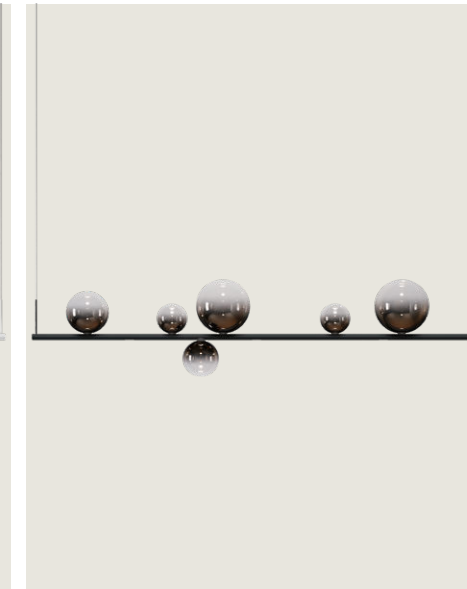



# Random Stick short NEW

| Description<br>Descrizione                    | Dimensions<br>Dimensioni |   |
|---|--------------------------|---|
| Metal structure<br>Montatura in metallo       | 100 cm<br>39,37"         | ① |
| Blown glass sphere<br>Sfera in vetro soffiato | Ø 10 cm<br>Ø 3,93"       | ② |
| Blown glass sphere<br>Sfera in vetro soffiato | Ø 12 cm<br>Ø 4,72"       | ③ |
| Blown glass sphere<br>Sfera in vetro soffiato | Ø 14 cm<br>Ø 5,51"       | ④ |
| Blown glass sphere<br>Sfera in vetro soffiato | Ø 10 cm<br>Ø 3,93"       | ⑤ |

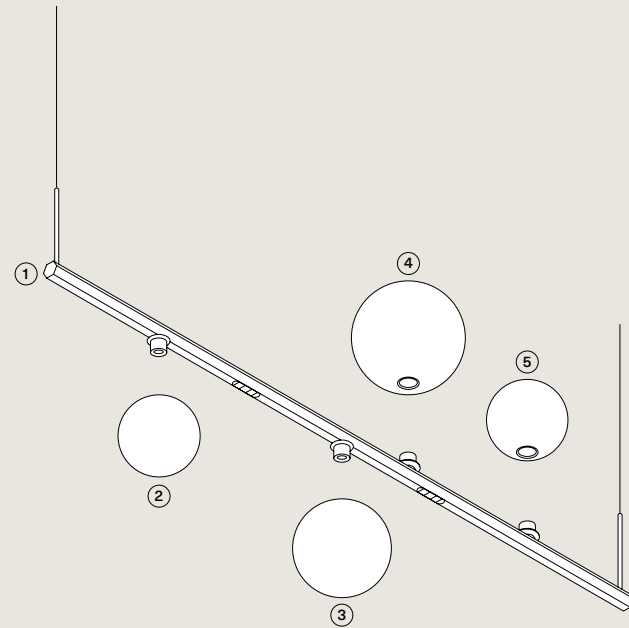

|                          |                     |               |   |                                   |   |
|--------------------------|---------------------|---------------|---|-----------------------------------|---|
| Net weight<br>Peso netto | 1,83 kg<br>4,03 lbs | Pack<br>Colli | 5 | Energy class<br>Classe energetica | D |
|--------------------------|---------------------|---------------|---|-----------------------------------|---|



For the product coding, see table ► P. 46  
Per la codifica del prodotto, consultare la tabella ► P. 46

## Random Stick short

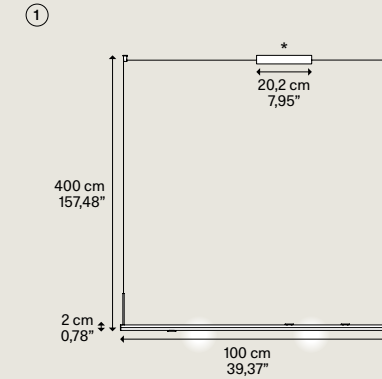

\* Adjustable canopy position  
\* Posizione del rosone regolabile

| Metal structure<br>Montatura in metallo |                    | Code<br>Codice | Code<br>Codice |
|---|--------------------|----------------|----------------|
| I Extra Matte White                     | Bianco Extra Opaco | 23420M 1027    | 23420M 1030    |
| II Black Chrome                         | Cromo Nero         | 23420M 2227    | 23420M 2230    |
| III Glossy Gold                         | Oro Lucido         | 23420M 5027    | 23420M 5030    |



### Light source Sorgente luminosa

LED  
2700 K  
17,5 W  
1500 lm  
220-240 V  
CRI 90  
MacAdam 3-Step

LED and driver included  
LED e driver inclusi

### Light source Sorgente luminosa

LED  
3000 K  
17,5 W  
1600 lm  
220-240 V  
CRI 90  
MacAdam 3-Step

LED and driver included  
LED e driver inclusi

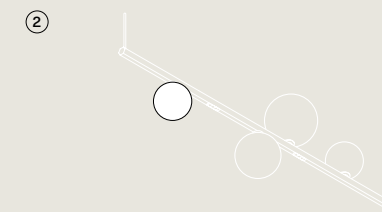

| Description<br>Descrizione  | Blown glass diffuser<br>Diffusore in vetro soffiato | Code<br>Codice |
|---|---|----------------|
| Blown glass sphere Ø 10 cm/3,93"<br>Sfera in vetro soffiato Ø 10 cm/3,93" | IV Clear<br>Trasparente                             | 17110V 00      |
|   | V Frosted White<br>Bianco Satinato                  | 17110V 13      |
|   | VI Chrome<br>Cromo                                  | 17110V 40      |
|   | VII Glossy Smoke<br>Fumo Lucido                     | 17110V 43      |
|   | VIII Glossy Bronze<br>Bronzo Lucido                 | 17110V 46      |
|   | IX Gold<br>Oro                                      | 17110V 50      |
|   | X Rose Gold<br>Oro Rosa                             | 17110V 55      |

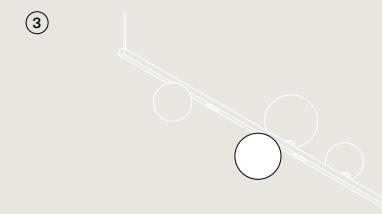

| Description<br>Descrizione  | Blown glass diffuser<br>Diffusore in vetro soffiato | Code<br>Codice |
|---|---|----------------|
| Blown glass sphere Ø 12 cm/4,72"<br>Sfera in vetro soffiato Ø 12 cm/4,72" | IV Clear<br>Trasparente                             | 17111V 00      |
|   | V Frosted White<br>Bianco Satinato                  | 17111V 13      |
|   | VI Chrome<br>Cromo                                  | 17111V 40      |
|   | VII Glossy Smoke<br>Fumo Lucido                     | 17111V 43      |
|   | VIII Glossy Bronze<br>Bronzo Lucido                 | 17111V 46      |
|   | IX Gold<br>Oro                                      | 17111V 50      |
|   | X Rose Gold<br>Oro Rosa                             | 17111V 55      |

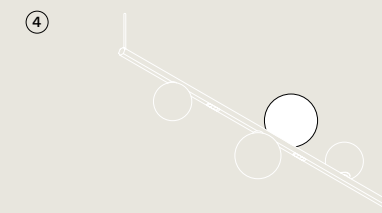

| Description<br>Descrizione  | Blown glass diffuser<br>Diffusore in vetro soffiato | Code<br>Codice |
|---|---|----------------|
| Blown glass sphere Ø 14 cm/5,51"<br>Sfera in vetro soffiato Ø 14 cm/5,51" | IV Clear<br>Trasparente                             | 17112V 00      |
|   | V Frosted White<br>Bianco Satinato                  | 17112V 13      |
|   | VI Chrome<br>Cromo                                  | 17112V 40      |
|   | VII Glossy Smoke<br>Fumo Lucido                     | 17112V 43      |
|   | VIII Glossy Bronze<br>Bronzo Lucido                 | 17112V 46      |
|   | IX Gold<br>Oro                                      | 17112V 50      |
|   | X Rose Gold<br>Oro Rosa                             | 17112V 55      |

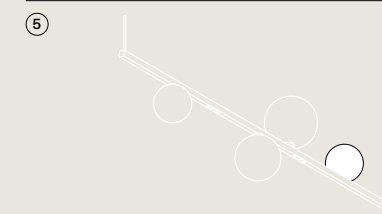

| Description<br>Descrizione  | Blown glass diffuser<br>Diffusore in vetro soffiato | Code<br>Codice |
|---|---|----------------|
| Blown glass sphere Ø 10 cm/3,93"<br>Sfera in vetro soffiato Ø 10 cm/3,93" | IV Clear<br>Trasparente                             | 17110V 00      |
|   | V Frosted White<br>Bianco Satinato                  | 17110V 13      |
|   | VI Chrome<br>Cromo                                  | 17110V 40      |
|   | VII Glossy Smoke<br>Fumo Lucido                     | 17110V 43      |
|   | VIII Glossy Bronze<br>Bronzo Lucido                 | 17110V 46      |
|   | IX Gold<br>Oro                                      | 17110V 50      |
|   | X Rose Gold<br>Oro Rosa                             | 17110V 55      |





# Random Stick long NEW

| Description<br>Descrizione                    | Dimensions<br>Dimensioni |   |
|---|--------------------------|---|
| Metal structure<br>Montatura in metallo       | 150 cm<br>59,05"         | ① |
| Blown glass sphere<br>Sfera in vetro soffiato | Ø 14 cm<br>Ø 5,51"       | ② |
| Blown glass sphere<br>Sfera in vetro soffiato | Ø 10 cm<br>Ø 3,93"       | ③ |
| Blown glass sphere<br>Sfera in vetro soffiato | Ø 12 cm<br>Ø 4,72"       | ④ |
| Blown glass sphere<br>Sfera in vetro soffiato | Ø 18 cm<br>Ø 7,08"       | ⑤ |
| Blown glass sphere<br>Sfera in vetro soffiato | Ø 10 cm<br>Ø 3,93"       | ⑥ |
| Blown glass sphere<br>Sfera in vetro soffiato | Ø 18 cm<br>Ø 7,08"       | ⑦ |

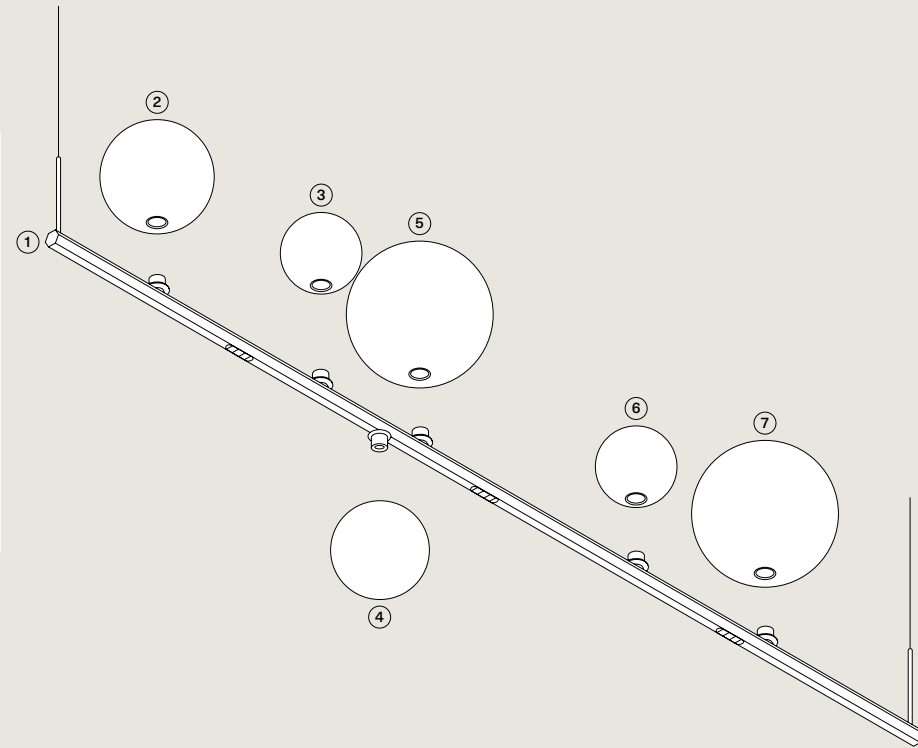

|                          |                     |               |   |                                   |   |
|--------------------------|---------------------|---------------|---|-----------------------------------|---|
| Net weight<br>Peso netto | 2,84 kg<br>6,26 lbs | Pack<br>Colli | 7 | Energy class<br>Classe energetica | D |
|--------------------------|---------------------|---------------|---|-----------------------------------|---|



For the product coding, see table ► p. 47  
Per la codifica del prodotto, consultare la tabella ► p. 47

## Random Stick long

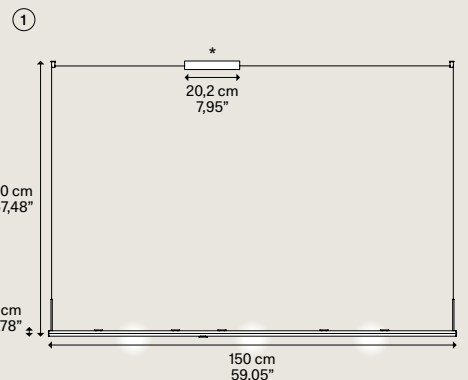

| Metal structure<br>Montatura in metallo |                    | Code<br>Codice | A | Code<br>Codice | B |
|---|--------------------|----------------|---|----------------|---|
| I Extra Matte White                     | Bianco Extra Opaco | 23421M 1027    |   | 23421M 1030    |   |
| II Black Chrome                         | Cromo Nero         | 23421M 2227    |   | 23421M 2230    |   |
| III Glossy Gold                         | Oro Lucido         | 23421M 5027    |   | 23421M 5030    |   |



**Light source  
Sorgente luminosa** **A**

|     |                |    |
|-----|----------------|----|
| LED | 2700           | K  |
|     | 22             | W  |
|     | 2250           | lm |
|     | 220-240        | V  |
|     | CRI 90         |    |
|     | MacAdam 3-Step |    |

**Light source  
Sorgente luminosa** **B**

|     |                |    |
|-----|----------------|----|
| LED | 3000           | K  |
|     | 22             | W  |
|     | 2400           | lm |
|     | 220-240        | V  |
|     | CRI 90         |    |
|     | MacAdam 3-Step |    |

LED and driver included  
LED e driver inclusi

LED and driver included  
LED e driver inclusi

\* Adjustable canopy position  
\* Posizione del rosone regolabile

## Random Stick long

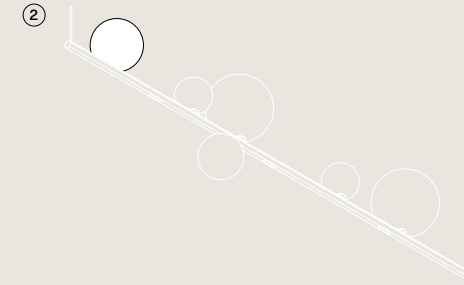

| Description<br>Descrizione            | Blown glass diffuser<br>Diffusore in vetro soffiato | Code<br>Codice |
|---------------------------------------|---|----------------|
| Blown glass sphere Ø 14 cm/5,51"      | IV Clear<br>Trasparente                             | 17112V 00      |
| Sfera in vetro soffiato Ø 14 cm/5,51" | V Frosted White<br>Bianco Satinato                  | 17112V 13      |
|                                       | VI Chrome<br>Cromo                                  | 17112V 40      |
|                                       | VII Glossy Smoke<br>Fumo Lucido                     | 17112V 43      |
|                                       | VIII Glossy Bronze<br>Bronzo Lucido                 | 17112V 46      |
|                                       | IX Gold<br>Oro                                      | 17112V 50      |
|                                       | X Rose Gold<br>Oro Rosa                             | 17112V 55      |

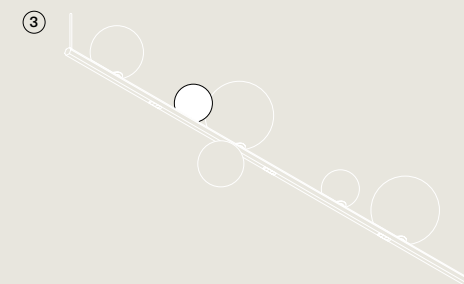

| Description<br>Descrizione            | Blown glass diffuser<br>Diffusore in vetro soffiato | Code<br>Codice |
|---------------------------------------|---|----------------|
| Blown glass sphere Ø 10 cm/3,93"      | IV Clear<br>Trasparente                             | 17110V 00      |
| Sfera in vetro soffiato Ø 10 cm/3,93" | V Frosted White<br>Bianco Satinato                  | 17110V 13      |
|                                       | VI Chrome<br>Cromo                                  | 17110V 40      |
|                                       | VII Glossy Smoke<br>Fumo Lucido                     | 17110V 43      |
|                                       | VIII Glossy Bronze<br>Bronzo Lucido                 | 17110V 46      |
|                                       | IX Gold<br>Oro                                      | 17110V 50      |
|                                       | X Rose Gold<br>Oro Rosa                             | 17110V 55      |

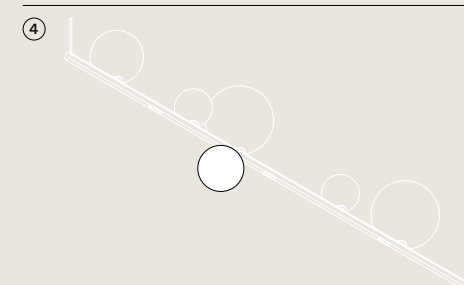

| Description<br>Descrizione            | Blown glass diffuser<br>Diffusore in vetro soffiato | Code<br>Codice |
|---------------------------------------|---|----------------|
| Blown glass sphere Ø 12 cm/4,72"      | IV Clear<br>Trasparente                             | 17111V 00      |
| Sfera in vetro soffiato Ø 12 cm/4,72" | V Frosted White<br>Bianco Satinato                  | 17111V 13      |
|                                       | VI Chrome<br>Cromo                                  | 17111V 40      |
|                                       | VII Glossy Smoke<br>Fumo Lucido                     | 17111V 43      |
|                                       | VIII Glossy Bronze<br>Bronzo Lucido                 | 17111V 46      |
|                                       | IX Gold<br>Oro                                      | 17111V 50      |
|                                       | X Rose Gold<br>Oro Rosa                             | 17111V 55      |

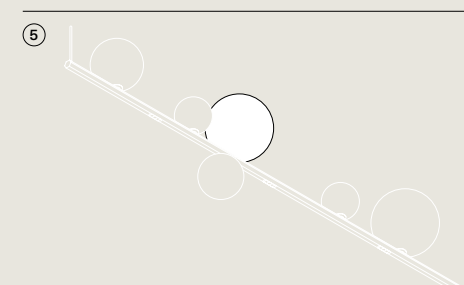

| Description<br>Descrizione            | Blown glass diffuser<br>Diffusore in vetro soffiato | Code<br>Codice |
|---------------------------------------|---|----------------|
| Blown glass sphere Ø 18 cm/7,08"      | IV Clear<br>Trasparente                             | 17113V 00      |
| Sfera in vetro soffiato Ø 18 cm/7,08" | V Frosted White<br>Bianco Satinato                  | 17113V 13      |
|                                       | VI Chrome<br>Cromo                                  | 17113V 40      |
|                                       | VII Glossy Smoke<br>Fumo Lucido                     | 17113V 43      |
|                                       | VIII Glossy Bronze<br>Bronzo Lucido                 | 17113V 46      |
|                                       | IX Gold<br>Oro                                      | 17113V 50      |
|                                       | X Rose Gold<br>Oro Rosa                             | 17113V 55      |

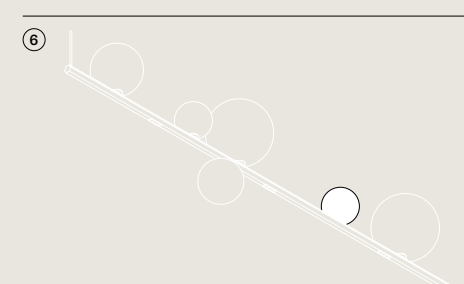

| Description<br>Descrizione            | Blown glass diffuser<br>Diffusore in vetro soffiato | Code<br>Codice |
|---------------------------------------|---|----------------|
| Blown glass sphere Ø 10 cm/3,93"      | IV Clear<br>Trasparente                             | 17110V 00      |
| Sfera in vetro soffiato Ø 10 cm/3,93" | V Frosted White<br>Bianco Satinato                  | 17110V 13      |
|                                       | VI Chrome<br>Cromo                                  | 17110V 40      |
|                                       | VII Glossy Smoke<br>Fumo Lucido                     | 17110V 43      |
|                                       | VIII Glossy Bronze<br>Bronzo Lucido                 | 17110V 46      |
|                                       | IX Gold<br>Oro                                      | 17110V 50      |
|                                       | X Rose Gold<br>Oro Rosa                             | 17110V 55      |

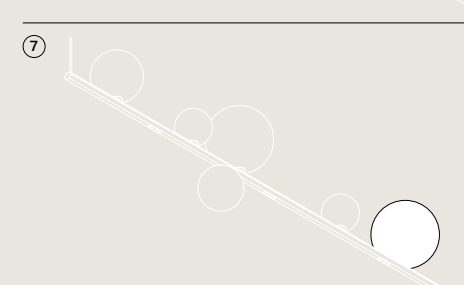

| Description<br>Descrizione            | Blown glass diffuser<br>Diffusore in vetro soffiato | Code<br>Codice |
|---------------------------------------|---|----------------|
| Blown glass sphere Ø 18 cm/7,08"      | IV Clear<br>Trasparente                             | 17113V 00      |
| Sfera in vetro soffiato Ø 18 cm/7,08" | V Frosted White<br>Bianco Satinato                  | 17113V 13      |
|                                       | VI Chrome<br>Cromo                                  | 17113V 40      |
|                                       | VII Glossy Smoke<br>Fumo Lucido                     | 17113V 43      |
|                                       | VIII Glossy Bronze<br>Bronzo Lucido                 | 17113V 46      |
|                                       | IX Gold<br>Oro                                      | 17113V 50      |
|                                       | X Rose Gold<br>Oro Rosa                             | 17113V 55      |



Random Stick short NEW

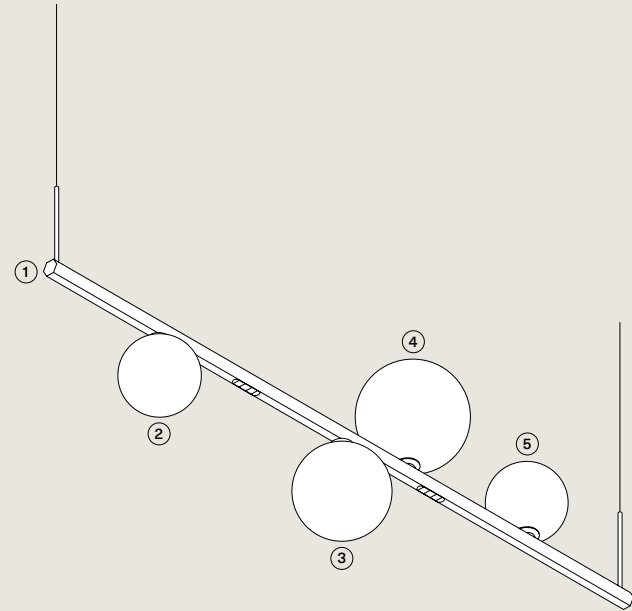

Create the product code  
Crea il codice prodotto

| Structure 100 |             | Sphere 10   | Sphere 12 | Sphere 14 | Sphere 10 |           |           |   |           |
|---------------|-------------|-------------|-----------|-----------|-----------|-----------|-----------|---|-----------|
| 2700 K        | 3000 K      |             |           |           |           |           |           |   |           |
| I             | 23420M 1027 | 23420M 1030 | IV        | 17110V 00 | 17111V 00 | 17112V 00 | 17110V 00 |   |           |
|               |             |             | V         | 17110V 13 | 17111V 13 | 17112V 13 | 17110V 13 |   |           |
| II            | 23420M 2227 | 23420M 2230 | VI        | 17110V 40 | 17111V 40 | 17112V 40 | 17110V 40 |   |           |
|               |             |             | VII       | 17110V 43 | 17111V 43 | 17112V 43 | 17110V 43 |   |           |
| III           | 23420M 5027 | 23420M 5030 | VIII      | 17110V 46 | 17111V 46 | 17112V 46 | 17110V 46 |   |           |
|               |             |             | IX        | 17110V 50 | 17111V 50 | 17112V 50 | 17110V 50 |   |           |
|               |             | X           | 17110V 55 | 17111V 55 | 17112V 55 | 17110V 55 |           |   |           |
|               |             |             | ①         | ②         | ③         | ④         | ⑤         |   |           |
| 23420M ____   |             | +           | 17110V __ | +         | 17111V __ | +         | 17112V __ | + | 17110V __ |

|     |                   |                    |      |               |               |
|-----|-------------------|--------------------|------|---------------|---------------|
| I   | Extra Matte White | Bianco Extra Opaco | VI   | Chrome        | Cromo         |
| II  | Black Chrome      | Cromo Nero         | VII  | Glossy Smoke  | Fumo Lucido   |
| III | Glossy Gold       | Oro Lucido         | VIII | Glossy Bronze | Bronzo Lucido |
| IV  | Clear             | Trasparente        | IX   | Gold          | Oro           |
| V   | Frosted White     | Bianco Satinato    | X    | Rose Gold     | Oro Rosa      |

Random Stick long NEW

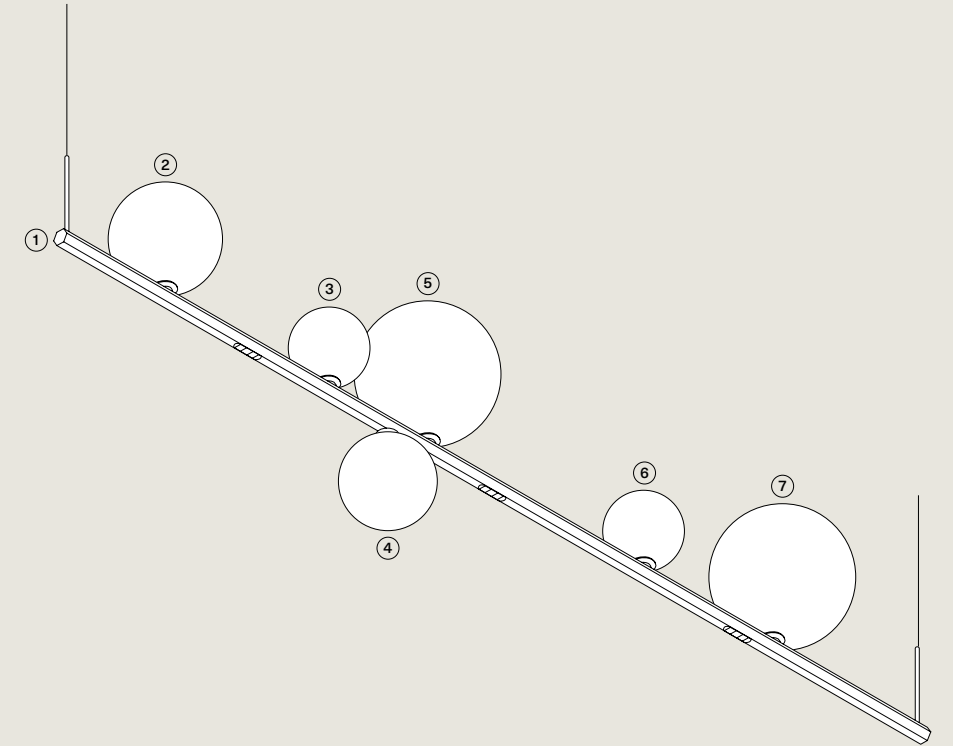

Create the product code  
Crea il codice prodotto

| Structure 150 |             | Sphere 14   | Sphere 10 | Sphere 12 | Sphere 18 | Sphere 10 | Sphere 18 |   |           |   |           |   |           |
|---------------|-------------|-------------|-----------|-----------|-----------|-----------|-----------|---|-----------|---|-----------|---|-----------|
| 2700 K        | 3000 K      |             |           |           |           |           |           |   |           |   |           |   |           |
| I             | 23421M 1027 | 23421M 1030 | IV        | 17112V 00 | 17110V 00 | 17111V 00 | 17113V 00 |   |           |   |           |   |           |
|               |             |             | V         | 17112V 13 | 17110V 13 | 17111V 13 | 17113V 13 |   |           |   |           |   |           |
| II            | 23421M 2227 | 23421M 2230 | VI        | 17112V 40 | 17110V 40 | 17111V 40 | 17113V 40 |   |           |   |           |   |           |
|               |             |             | VII       | 17112V 43 | 17110V 43 | 17111V 43 | 17113V 43 |   |           |   |           |   |           |
| III           | 23421M 5027 | 23421M 5030 | VIII      | 17112V 46 | 17110V 46 | 17111V 46 | 17113V 46 |   |           |   |           |   |           |
|               |             |             | IX        | 17112V 50 | 17110V 50 | 17111V 50 | 17113V 50 |   |           |   |           |   |           |
|               |             | X           | 17112V 55 | 17110V 55 | 17111V 55 | 17113V 55 |           |   |           |   |           |   |           |
|               |             |             | ①         | ②         | ③         | ④         | ⑤         | ⑥ | ⑦         |   |           |   |           |
| 23421M ____   |             | +           | 17112V __ | +         | 17110V __ | +         | 17111V __ | + | 17113V __ | + | 17110V __ | + | 17113V __ |

|     |                   |                    |      |               |               |
|-----|-------------------|--------------------|------|---------------|---------------|
| I   | Extra Matte White | Bianco Extra Opaco | VI   | Chrome        | Cromo         |
| II  | Black Chrome      | Cromo Nero         | VII  | Glossy Smoke  | Fumo Lucido   |
| III | Glossy Gold       | Oro Lucido         | VIII | Glossy Bronze | Bronzo Lucido |
| IV  | Clear             | Trasparente        | IX   | Gold          | Oro           |
| V   | Frosted White     | Bianco Satinato    | X    | Rose Gold     | Oro Rosa      |



# *Lodes: Family Extension*

Volum, design by Snøhetta



Short 29

Long 29



Short 42

Long 42

Tidal, design by Needs Studio



45

75



## Volum, design by Snøhetta, 2022/2024

*Volum* celebrates the elegance of simplicity with a series of lamps that, in their similar yet intimately different shapes, complement each other in poetic compositions that narrate an all-round illumination, tailored for various functions and uses. Behind its apparent simplicity, the collection designed in collaboration with architectural firm Snøhetta conceals a complex technical achievement, paying homage to the ancient glassblowing technique that gives life to naturally imperfect shapes. The blown glass spheres of the diffuser, available in diameters of 14, 22, 29, and 42 cm, feature a glossy white finish that evenly radiates light. The *Volum* family includes various models – cluster suspension, ceiling, wall, table, and floor lamps – that enhance any space and situation, whether used individually or in compositions to create original lighting solutions.

*Volum* celebra l'eleganza del minimalismo con una serie di lampade che, nelle loro forme simili ma intimamente diverse, si completano in poetiche composizioni che raccontano un'illuminazione a 360°, declinata in diverse funzioni e utilizzi. Dietro la sua apparente semplicità, la collezione disegnata con lo studio Snøhetta cela una complessa realizzazione e un omaggio all'antica tecnica della soffiatura del vetro che dà vita a forme naturalmente imperfette. Le sfere in vetro soffiato del diffusore, disponibili nelle misure 14, 22, 29 e 42 cm di diametro, sono caratterizzate da una finitura bianca lucida che irradia la luce in modo uniforme. La famiglia *Volum* include varie funzioni – sospensione cluster, sospensione, soffitto, parete, tavolo e terra – in grado di aggiungere valore a qualsiasi spazio e situazione, da sole o in composizione per creare originali soluzioni luminose.

● Spec sheet p. 58

| VOLUM | CATEGORY LAMP | TYPE OF LIGHT               |
|-------|---------------|-----------------------------|
|       | Floor Terra   | Diffused light Luce diffusa |

NEW LAMP















1

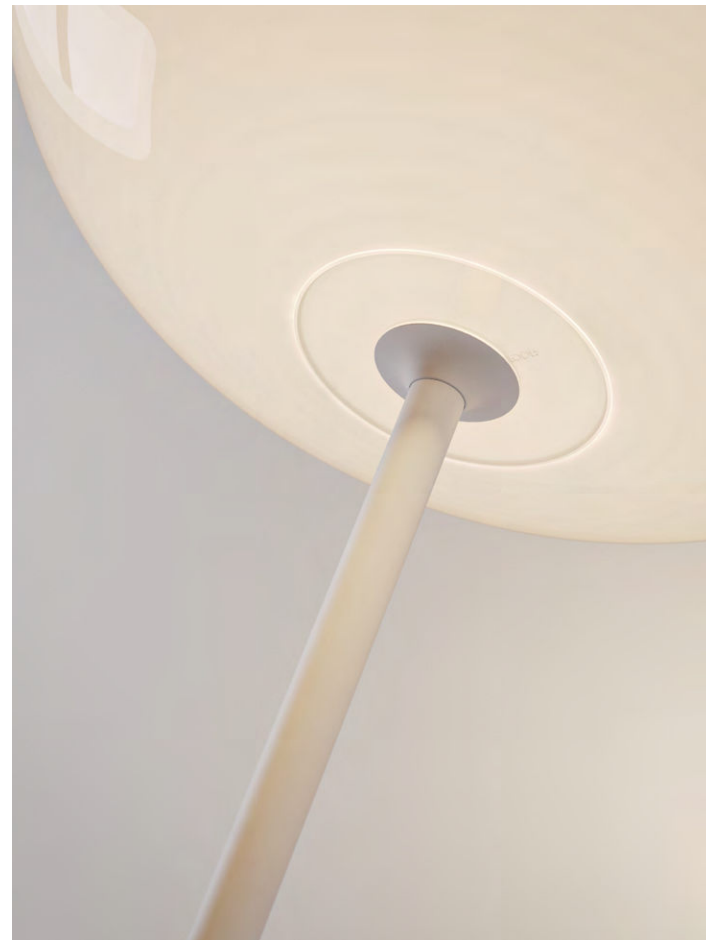

2



3

- 1 Volum, FINISH Glossy White.
- 2 Volum, blown glass diffuser, FINISH Glossy White.
- 3 Volum, metal stem and base, FINISH White.

*Volum* célèbre l'élégance de la simplicité à travers une série de lampes qui, dans leurs formes similaires mais intimement différentes, se complètent dans des compositions poétiques qui transmettent un éclairage complet, décliné en différentes fonctions et utilisations. Mais derrière sa simplicité apparente, la collection conçue avec le studio Snøhetta dissimule une réalisation complexe et un hommage à l'ancienne technique du soufflage du verre qui donne vie à des formes naturellement imparfaites. Les sphères en verre soufflé du diffuseur, disponibles dans les diamètres 14, 22, 29 et 42 cm, se caractérisent par une finition blanc brillant qui diffuse uniformément la lumière. La famille *Volum* prévoit différentes fonctions – suspension en cluster, suspension, plafonnier, applique, table et sol – en mesure de valoriser tous les types d'espace et situation, seules ou en composition pour créer des solutions d'éclairage originales. ●FR

*Volum* celebra la elegancia de la simplicidad con una serie de lámparas que, en sus formas parecidas e intimamente distintas a la vez, se completan en composiciones poéticas que narran una iluminación a 360° con diferentes funciones y usos. Detrás de su aparente simplicidad, la colección diseñada con el estudio Snøhetta esconde una compleja realización y un homenaje a la antigua técnica del soplado del vidrio que da vida a formas naturalmente imperfectas. Las esferas de vidrio soplado del difusor, disponibles en las medidas 14, 22, 29 y 42 cm de diámetro, se caracterizan por un acabado blanco brillante que proyecta la luz de manera uniforme. La familia *Volum* incluye varias funciones – suspensión cluster, suspensión, techo, pared, sobremesa y pie – capaces de aportar valor añadido a cualquier espacio y situación, por sí solas o en composiciones para crear originales soluciones de iluminación. ●ES

*Volum* прославляет элегантность простоты серий ламп с похожими, но совершенно разными формами, дополняющих друг друга в поэтических композициях, с освещением на 360°, с различными функциями и способами применения. За кажущейся простотой коллекция, разработанная совместно со студией Snøhetta, скрывает сложную техническую реализацию, отдающую дань уважения древней технике выдувания стекла, которая создает естественно несовершенные формы. Сферы диффузора из дутого стекла, с размерами 14, 22, 29 и 42 см в диаметре, характеризуются глянцевой белой отделкой, равномерно излучающей свет. Семейство *Volum* включает в себя различные функциональные формы, кластерную подвесную, подвесную, потолочную, настенную, настольную и напольную, способные украсить любое пространство и ситуацию, по отдельности или в композиции, для создания оригинальных световых решений. ●RU

*Volum* celebra la elegancia de la simplicidad con una serie de lámparas que, en sus formas parecidas e intimamente distintas a la vez, se completan en composiciones poéticas que narran una iluminación a 360° con diferentes funciones y usos. Detrás de su aparente simplicidad, la colección diseñada con el estudio Snøhetta esconde una compleja realización y un homenaje a la antigua técnica del soplado del vidrio que da vida a formas naturalmente imperfectas. Las esferas de vidrio soplado del difusor, disponibles en las medidas 14, 22, 29 y 42 cm de diámetro, se caracterizan por un acabado blanco brillante que proyecta la luz de manera uniforme. La familia *Volum* incluye varias funciones – suspensión cluster, suspensión, techo, pared, sobremesa y pie – capaces de aportar valor añadido a cualquier espacio y situación, por sí solas o en composiciones para crear originales soluciones de iluminación. ●ES

*Volum* прославляет элегантность простоты серий ламп с похожими, но совершенно разными формами, дополняющих друг друга в поэтических композициях, с освещением на 360°, с различными функциями и способами применения. За кажущейся простотой коллекция, разработанная совместно со студией Snøhetta, скрывает сложную техническую реализацию, отдающую дань уважения древней технике выдувания стекла, которая создает естественно несовершенные формы. Сферы диффузора из дутого стекла, с размерами 14, 22, 29 и 42 см в диаметре, характеризуются глянцевой белой отделкой, равномерно излучающей свет. Семейство *Volum* включает в себя различные функциональные формы, кластерную подвесную, подвесную, потолочную, настенную, настольную и напольную, способные украсить любое пространство и ситуацию, по отдельности или в композиции, для создания оригинальных световых решений. ●RU

*Volum*以一系列灯具礼赞简约的优雅。这些灯具形状相似却又截然不同,在充满诗意的组合中相互补充,传达能够用于不同功能和用途的360°照明。然而在其看似简单的背后,这个与Snøhetta建筑工作室联袂设计的系列却隐藏着一种复杂的技术制作工艺并礼赞古老的吹制玻璃技术,这种技术为那些以自然方式不甚完美的形状赋予生命。灯罩的吹制玻璃球体提供直径14、22、29和42厘米这几种可选尺寸,可均匀辐射光线的亮白色饰面是其特征所在。 *Volum*系列包含各种功能 – 组合悬吊灯、悬吊灯、吸顶灯、壁灯、台灯和落地灯 – 它们能够为任何空间和场合增值,单独或组合构建原创照明解决方案。 ●ZH

Volum short & long 29 » Floor lamp **NEW LAMP**



Volum short & long 42 » Floor lamp **NEW LAMP**



57 Floor lamp



Volum

Volum short 29 **NEW**

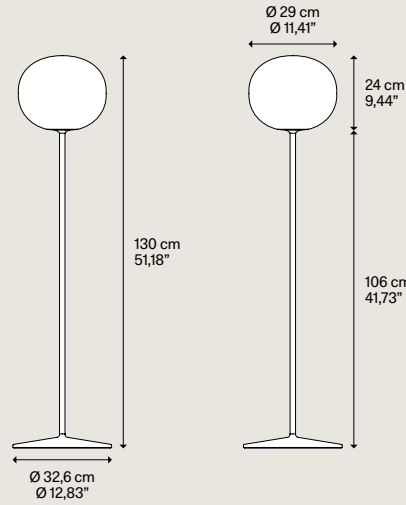

Metal structure  
Montatura in metallo

White  
Bianco

Blown glass diffuser  
Diffusore in vetro soffiato

Glossy White  
Bianco Lucido

Code  
Codice

18771 1200

Light source  
Sorgente luminosa

E27 LED 1 x 25 W  
Ø max 6 cm  
Ø max 2,36"  
W/L max 12,5 cm  
W/L max 4,92"

Bulb not included  
Lampadina non inclusa  
Dimmer switch on the cord  
Interuttore con dimmer sul cavo

Net weight 8,33 kg  
Peso netto 18,36 lbs  
Pack Colli 2  
Energy class Classe energetica D



Volum short 42 **NEW**

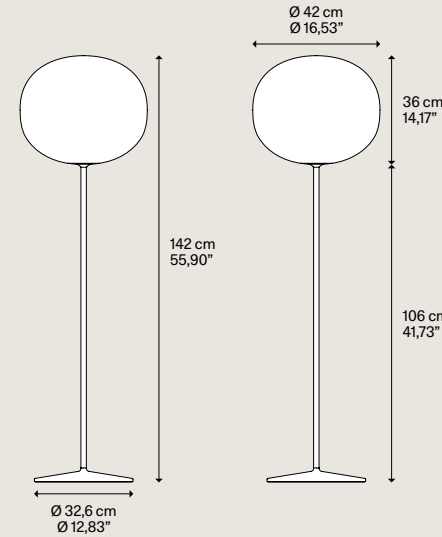

Metal structure  
Montatura in metallo

White  
Bianco

Blown glass diffuser  
Diffusore in vetro soffiato

Glossy White  
Bianco Lucido

Code  
Codice

18772 1200

Light source  
Sorgente luminosa

E27 LED 1 x 25 W  
Ø max 9,8 cm  
Ø max 3,85"

Bulb not included  
Lampadina non inclusa  
Dimmer switch on the cord  
Interuttore con dimmer sul cavo

Net weight 9,53 kg  
Peso netto 21,01 lbs  
Pack Colli 2  
Energy class Classe energetica D



Volum long 29 **NEW**

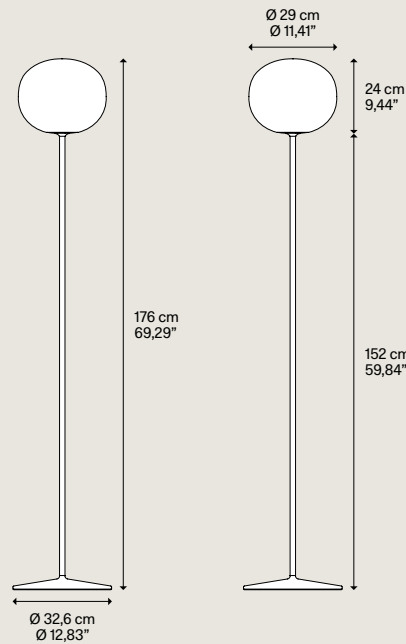

Metal structure  
Montatura in metallo

White  
Bianco

Blown glass diffuser  
Diffusore in vetro soffiato

Glossy White  
Bianco Lucido

Code  
Codice

18773 1200

Light source  
Sorgente luminosa

E27 LED 1 x 25 W  
Ø max 6 cm  
Ø max 2,36"  
W/L max 12,5 cm  
W/L max 4,92"

Bulb not included  
Lampadina non inclusa  
Dimmer switch on the cord  
Interuttore con dimmer sul cavo

Net weight 8,67 kg  
Peso netto 19,11 lbs  
Pack Colli 2  
Energy class Classe energetica D



Volum long 42 **NEW**

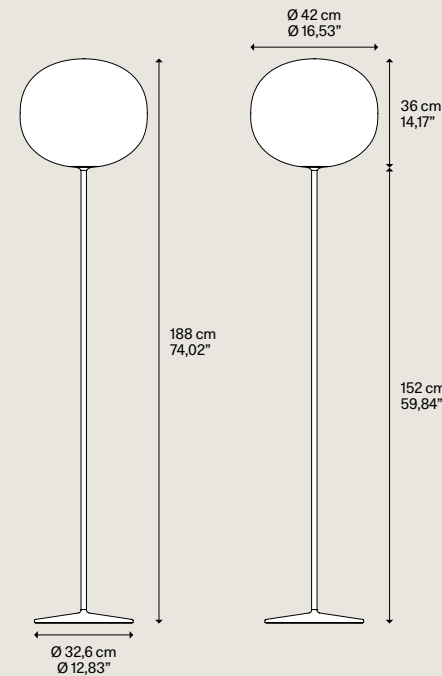

Metal structure  
Montatura in metallo

White  
Bianco

Blown glass diffuser  
Diffusore in vetro soffiato

Glossy White  
Bianco Lucido

Code  
Codice

18774 1200

Light source  
Sorgente luminosa

E27 LED 1 x 25 W  
Ø max 9,8 cm  
Ø max 3,85"

Bulb not included  
Lampadina non inclusa  
Dimmer switch on the cord  
Interuttore con dimmer sul cavo

Net weight 9,87 kg  
Peso netto 21,75 lbs  
Pack Colli 2  
Energy class Classe energetica D



| Light source<br>Sorgente luminosa                                 | Bulb dimension<br>Dimensione lampadina          | Pack<br>Colli | Code<br>Codice |
|---|---|---------------|----------------|
| E27 LED T28 10 W<br>2700 K<br>1000 lm<br>CRI 90<br>MacAdam 3-Step | Ø 2,8 cm<br>Ø 1,10"<br>W/L 11,3 cm<br>W/L 4,44" | 1             | LAM-0014       |

| Light source<br>Sorgente luminosa                                 | Bulb dimension<br>Dimensione lampadina        | Pack<br>Colli | Code<br>Codice |
|---|---|---------------|----------------|
| E27 LED T35 21 W<br>2700 K<br>2010 lm<br>CRI 90<br>MacAdam 3-Step | Ø 3,5 cm<br>Ø 1,37"<br>W/L 15 cm<br>W/L 5,90" | 1             | LAM-0016       |



# Tidal, *design by* Needs Studio, 2023/2024

*Tidal* is a ceiling lamp with high luminous efficiency that captures the essence of the movements of celestial bodies and tides with a fluid and impactful design. The lamp indeed appears different depending on the perspective from below, thanks to its irregular asymmetrical shape, with one side wider than the other. Made of die-cast aluminium, the lamp's body projects light both downward and upward simultaneously, while a ring conceals its internal technical elements, enhancing its aesthetic value. *Tidal* is available in three sizes – 45, 60, and 75 cm – and in four matt finishes – white, terra, champagne, and black – suitable for minimalist environments as well as spaces that demand warmer, more elegant tones.

*Tidal* è una lampada da soffitto con un'alta efficienza luminosa, che cattura l'essenza dei movimenti dei corpi celesti e delle maree con un design fluido e di forte impatto: la lampada, infatti, appare diversa a seconda di come la si osserva dal basso grazie alla sua forma asimmetrica irregolare, con un lato più largo dell'altro. La scocca della lampada, in pressofusione di alluminio, proietta la luce contemporaneamente verso il basso e verso l'alto, mentre l'anello nasconde gli elementi tecnici al suo interno, enfatizzando il valore estetico dell'oggetto. *Tidal* è disponibile in tre dimensioni – 45, 60 e 75 cm – e in quattro finiture opache – bianco, terra, champagne e nero – che si adattano sia ad ambienti minimalisti sia a spazi che richiedono toni più caldi ed eleganti.

● Spec sheet p. 68



| TIDAL | CATEGORY LAMP |          | TYPE OF LIGHT              |                         |
|-------|---------------|----------|----------------------------|-------------------------|
|       | Ceiling       | Soffitto | Symmetrical diffused light | Luce simmetrica diffusa |

NEW LAMP











Tidal 45, FINISH Matte Champagne.



Tidal 75, 45 and 60, FINISHES Matte Black, Champagne, Terra and White.





*Tidal* est un plafonnier à haute efficacité lumineuse, qui capture l'essence des mouvements des corps célestes et des marées avec un design fluide et impactant : la lampe, en effet, semble différente selon le point d'observation par le bas grâce à sa forme asymétrique irrégulière, avec un côté plus large que l'autre. Le corps de la lampe, en aluminium moulé sous pression, projette la lumière simultanément vers le bas et vers le haut, tandis que l'anneau renferme les éléments techniques, soulignant la valeur esthétique de l'objet. *Tidal* est disponible en trois tailles – 45, 60 et 75 cm – et en quatre finitions mates – blanc, terre, champagne et noir – qui épousent parfaitement les environnements minimalistes mais aussi les espaces qui nécessitent des tons plus chauds et élégants. ● FR

*Tidal* ist eine Deckenleuchte mit hoher Leuchteffizienz, die das Wesen der Bewegungen der Himmelskörper und der Gezeiten mit einem fließenden, effektvollen Design einfängt: Die Leuchte wirkt je nach Blickwinkel von unten anders, da sie eine unregelmäßige, asymmetrische Form hat, bei der eine Seite breiter ist als die andere. Der Leuchtenkörper aus Aluminiumdruckguss projiziert das Licht gleichzeitig nach unten und nach oben, während der Ring die technischen Elemente im Inneren verbirgt und den ästhetischen Wert des Objekts unterstreicht. *Tidal* ist in drei Größen – 45, 60 und 75 cm – und in vier matten Ausführungen – Weiß, Terra, Champagner und Schwarz – erhältlich, die sowohl zu minimalistischen Ambienten als auch zu Räumen passen, die wärmere, elegantere Töne erfordern. ● DE

*Tidal* es una lámpara de techo con un alta eficiencia de iluminación que capta la esencia de los movimientos de los cuerpos celestes y las mareas con un diseño fluido y de gran impacto: de hecho la lámpara parece distinta dependiendo de cómo se observe desde abajo gracias a su forma asimétrica irregular, con un lado más ancho que el otro. El armazón de la lámpara, de aluminio fundido a presión, proyecta la luz simultáneamente hacia abajo y hacia arriba, mientras que el anillo oculta los elementos técnicos en su interior, lo que enfatiza el valor estético del objeto. *Tidal* está disponible en tres tamaños – 45, 60 y 75 cm – y en cuatro acabados mate – blanco, tierra, champán y negro – que se adaptan tanto a ambientes minimalistas como a espacios que requieren tonos más cálidos y elegantes. ● ES

*Tidal* 是一款发光效率极高的吸顶灯,它以流畅且具有强烈冲击力的设计捕捉了天体和潮汐运动的本质:事实上,根据您从下方观察它的方式,这款灯会呈现出不同效果。这要归功于其不规则的不对称形状,一侧较另一侧更宽。灯体外壳采用压铸铝制成,向下和向上同时投射光线,而圆环则将各种技术元素隐匿在内,彰显了产品的美学价值。*Tidal*提供45、60和75厘米这三种尺寸以及白色、大地色、香槟色和黑色这四种饰面,既适合极简环境,也适合需要色调更为温暖优雅的空间。● ZHW

*Tidal* – это потолочный светильник, отличающийся высокой светоотдачей, улавливающий суть движений небесных тел, приливов и отливов. Он характеризуется текучим впечатляющим дизайном: вид лампы меняется в зависимости от точки обзора снизу, вследствие ее неправильной асимметричной формы, с одной стороной шире другой. Корпус лампы из литого под давлением алюминия проецирует свет одновременно вниз и вверх, а кольцо скрывает технические элементы, подчеркивая эстетическую ценность объекта. *Tidal* выпускается трех размеров, 45, 60 и 75 см, с четырьмя матовыми отделками – белая, terra, шампанге и черная, которые подходят как для минималистской обстановки, так и для пространств, требующих более теплых и элегантных тонов. ● RU

Tidal 45 ↘ Ceiling lamp **NEW LAMP**



Tidal 60 ↘ Ceiling lamp



Tidal 75 ↘ Ceiling lamp **NEW LAMP**



67 Ceiling lamp





Tidal 45 NEW

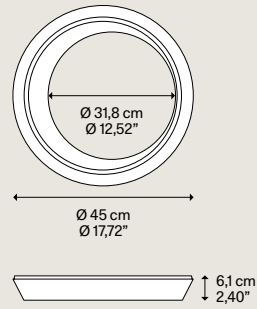

| Metal structure<br>Montatura in metallo   | Code<br>Codice | A | Code<br>Codice | B |
|---|----------------|---|----------------|---|
| Matte White – 9010<br>Bianco Opaco – 9010 | 19931 1027     |   | 19931 1030     |   |
| Matte Black – 9005<br>Nero Opaco – 9005   | 19931 2027     |   | 19931 2030     |   |
| Matte Champagne<br>Champagne Opaco        | 19931 4527     |   | 19931 4530     |   |
| Terra<br>Terra                            | 19931 6727     |   | 19931 6730     |   |

**Light source**  
Sorgente luminosa

**A**

| LED  | K | W  | lm   | V       | mA     |
|------|---|----|------|---------|--------|
| 2700 |   | 30 | 5040 | 220-240 | CRI 90 |
| 3000 |   | 30 | 5292 | 220-240 | CRI 90 |

MacAdam 3-Step

LED and driver included  
LED e driver inclusi

**Light source**  
Sorgente luminosa

**B**

| LED  | K | W  | lm   | V       | mA     |
|------|---|----|------|---------|--------|
| 2700 |   | 30 | 5040 | 220-240 | CRI 90 |
| 3000 |   | 30 | 5292 | 220-240 | CRI 90 |

MacAdam 3-Step

LED and driver included  
LED e driver inclusi

Net weight 2,80 kg  
Peso netto 6,17 lbs

Pack Colli 1

Energy class Classe energetica C



Tidal 60

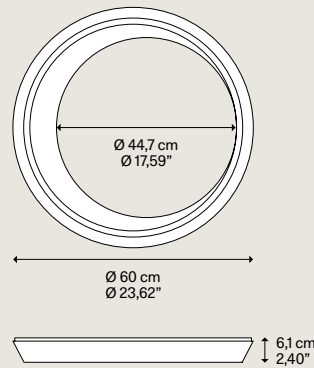

| Metal structure<br>Montatura in metallo   | Code<br>Codice | A | Code<br>Codice | B |
|---|----------------|---|----------------|---|
| Matte White – 9010<br>Bianco Opaco – 9010 | 19933 1027     |   | 19933 1030     |   |
| Matte Black – 9005<br>Nero Opaco – 9005   | 19933 2027     |   | 19933 2030     |   |
| Matte Champagne<br>Champagne Opaco        | 19933 4527     |   | 19933 4530     |   |
| Terra<br>Terra                            | 19933 6727     |   | 19933 6730     |   |

**Light source**  
Sorgente luminosa

**A**

| LED  | K | W  | lm   | V       | mA  |
|------|---|----|------|---------|-----|
| 2700 |   | 48 | 6975 | 220-240 | 600 |
| 3000 |   | 48 | 7320 | 220-240 | 600 |

MacAdam 3-Step

LED and driver included  
LED e driver inclusi

Double switch  
Doppia accensione

The driver, included, is supplied with an output voltage of 600 mA but can be adjusted during installation

Il driver, incluso, è fornito con una corrente di uscita impostata a 600 mA ma può essere regolato in installazione

|          |      |         |
|----------|------|---------|
| ▶ 500 mA | 40 W | 6083 lm |
| ▶ 550 mA | 44 W | 6529 lm |

**Light source**  
Sorgente luminosa

**B**

| LED  | K | W  | lm   | V       | mA  |
|------|---|----|------|---------|-----|
| 2700 |   | 48 | 6975 | 220-240 | 600 |
| 3000 |   | 48 | 7320 | 220-240 | 600 |

MacAdam 3-Step

LED and driver included  
LED e driver inclusi

Double switch  
Doppia accensione

The driver, included, is supplied with an output voltage of 600 mA but can be adjusted during installation

Il driver, incluso, è fornito con una corrente di uscita impostata a 600 mA ma può essere regolato in installazione

|          |      |         |
|----------|------|---------|
| ▶ 500 mA | 40 W | 6385 lm |
| ▶ 550 mA | 44 W | 6853 lm |

Net weight 3,90 kg  
Peso netto 8,60 lbs

Pack Colli 1

Energy class Classe energetica C



Tidal 75 NEW

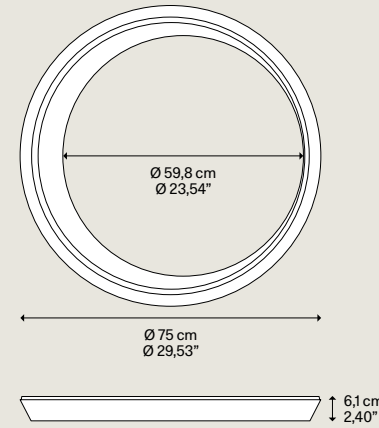

| Metal structure<br>Montatura in metallo   | Code<br>Codice | A | Code<br>Codice | B |
|---|----------------|---|----------------|---|
| Matte White – 9010<br>Bianco Opaco – 9010 | 19932 1027     |   | 19932 1030     |   |
| Matte Black – 9005<br>Nero Opaco – 9005   | 19932 2027     |   | 19932 2030     |   |
| Matte Champagne<br>Champagne Opaco        | 19932 4527     |   | 19932 4530     |   |
| Terra<br>Terra                            | 19932 6727     |   | 19932 6730     |   |

**Light source**  
Sorgente luminosa

**A**

| LED  | K | W  | lm   | V       | mA  |
|------|---|----|------|---------|-----|
| 2700 |   | 55 | 8589 | 220-240 | 700 |
| 3000 |   | 55 | 9072 | 220-240 | 700 |

MacAdam 3-Step

LED and driver included  
LED e driver inclusi

Double switch  
Doppia accensione

The driver, included, is supplied with an output voltage of 700 mA but can be adjusted during installation

Il driver, incluso, è fornito con una corrente di uscita impostata a 700 mA ma può essere regolato in installazione

|          |      |         |
|----------|------|---------|
| ▶ 500 mA | 39 W | 6855 lm |
| ▶ 550 mA | 43 W | 7289 lm |
| ▶ 600 mA | 47 W | 7722 lm |

**Light source**  
Sorgente luminosa

**B**

| LED  | K | W  | lm   | V       | mA  |
|------|---|----|------|---------|-----|
| 2700 |   | 55 | 8589 | 220-240 | 700 |
| 3000 |   | 55 | 9072 | 220-240 | 700 |

MacAdam 3-Step

LED and driver included  
LED e driver inclusi

Double switch  
Doppia accensione

The driver, included, is supplied with an output voltage of 700 mA but can be adjusted during installation

Il driver, incluso, è fornito con una corrente di uscita impostata a 700 mA ma può essere regolato in installazione

|          |      |         |
|----------|------|---------|
| ▶ 500 mA | 39 W | 7236 lm |
| ▶ 550 mA | 43 W | 7695 lm |
| ▶ 600 mA | 47 W | 8154 lm |

Net weight 5,38 kg  
Peso netto 11,86 lbs

Pack Colli 1

Energy class Classe energetica C



| Light emission<br>Emissione luminosa                               | Tidal 45 |         |   | Tidal 60 |         |        | Tidal 75 |         |        |
|--|----------|---------|---|----------|---------|--------|----------|---------|--------|
| <b>A</b><br>Direct light emission<br>Emissione di luce diretta     | 2700 K   | 3600 lm | - | 2700 K   | 4463 lm | 500 mA | 2700 K   | 4335 lm | 500 mA |
|  |          |         |   |          | 4909 lm | 550 mA |          | 4769 lm | 550 mA |
| <b>B</b><br>Indirect light emission<br>Emissione di luce indiretta | 3000 K   | 3780 lm | - | 3000 K   | 4675 lm | 500 mA | 3000 K   | 4590 lm | 500 mA |
|  |          |         |   |          | 5143 lm | 550 mA |          | 5049 lm | 550 mA |
|  |          |         |   |          | 5610 lm | 600 mA |          | 5508 lm | 600 mA |
|  |          |         |   |          |         |        |          | 6426 lm | 700 mA |



**Art. 1 Recital**  
Unless otherwise provided for in a separate written agreement between the parties, every sale of products of Lodes S.r.l., VAT 02992370276 (hereinafter, “the Seller”) is governed by the following General Conditions of Sale that must be considered as an essential part of this agreement and shall be deemed to have been accepted by the Buyer even though the latter has not signed them. Any clause unilaterally added by the Buyer in the documentation signed by it and /or in its correspondence, being against or in any case in addition to the general conditions or to those specific expressly approved in writing by the Seller, shall be deemed as not written and shall be of no effect.

**Art. 2 Completion of the sale, quantities and prices**  
The sale is deemed to be completed once the Seller gives the written order confirmation also by fax and / or email or when deliveries are commenced in cases where the immediate delivery of the supply is requested, also in consideration of changes occurred and then accepted by the customer. The prices agreed are understood for products delivered ex works of the Seller and do not include services and accessory charges (such as VAT, special packaging, transport and installation costs, and / or assemblages and so on).

**Art. 3 Delivery, risk transfer and transport**  
Products are delivered to the Buyer at the Seller's plant or at another place indicated in writing by the Seller, and the risk transfer takes place with the delivery of the goods to the first carrier or Buyer in the events of collection of goods directly carried out by the latter. The products always travel at the Buyer's sole risk also when the carrier is selected and appointed by the Seller, being the latter freed from all responsibilities after having delivered the products to the carrier, this delivery is deemed to all effects being carried out directly by the said Buyer. The delivery terms agreed are to be understood as indicative. If the Seller is responsible for delay of delivery for a period of up to 60 days, the Buyer is not entitled either to refuse the supply or to request the termination of the agreement and / or the compensation for any damages. If the delay in delivery exceeds 60 days, the Buyer is entitled to request – by registered letter – the cancellation of the order and the reimbursement of the advances if paid. In any event, the Seller shall not be liable for and / or direct and indirect damages of any nature and for any reason due to the delay or the failure to carry out the supply.

**Art. 4 Reservation of title**  
he Buyer acquires property rights over the goods with the full payment of the price invoiced of the supplies but it takes the risks thereof as of the delivery.

**Art. 5 Products features and conditions of use**  
Unless otherwise expressly agreed in writing by the parties, the conditions for using of the products are those communicated or in any case resulting from the drawings and technical specifications of the Seller, if any, or as described in the website [www.lodes.com](http://www.lodes.com) in relation to products. The quality levels of products are the standard quality levels of the Sellers, indicated in the relevant specifications as described on the Seller's website. It is always the Buyer's responsibility to identify and notify the Seller of the conditions of use of products before technically defining them. Failing any particular instructions from the Buyer, the Seller considers as usual conditions of use those it considered or described in its designs and technical documentation. Drawings, materials, and colours of the products included in catalogues / website and more generally in all advertising material are indicative. The Seller reserves the right, without notice, to modify the characteristics of its products, as well as their availability. Technical data, images, and information regarding the products are not binding on the Seller, who will not be held responsible for any discrepancies and / or illustrative and / or textual errors. Further product characteristics are contained in the respective technical sheets and / or instruction sheets.

**Art. 6 Warranties**  
The products delivered are covered by a warranty for defects in material and manufacture for a period of 24 months as of the delivery if the Buyer is a natural person, otherwise the warranty period will be of 12 months as of the delivery. The Seller shall replace the products delivered in this warranty period being faulty due to factory defects or in alternative, at its discretion, pay the Buyer an amount equal to the price already invoiced of the said products, being expressly excluded and waived any other right or claim by the Buyer also as compensation for direct and / or indirect damages or cost repayment borne by it (such as recovery, technical assistance, recalling costs, etc.). The Seller will anticipate the delivery of the replaced product, invoicing it regularly. Successively, when the product arrives to the Seller's warehouse, the latter will credit the amount of the defective product. The transport's costs will be paid by the Seller. Should the defected item be returned in an inadequate non-original packaging, with damages connected to the transport, The Seller will not credit any amount to the Buyer, and it will return the product to the sender at his own expenses. If the replacement was made for alleged defects in material and manufacture, but after the control carried out by the Seller, it is considered (i) unfounded, due to the absence of defects; (ii) further damaged by insufficient packaging in the return transport (iii) spoiled by tampering made by the Buyer, all transportation costs and the entire value of the product will be charged to the latter. Any defectiveness or non-compliance of products shall be reported by the Buyer by writing to the Seller – in order to be valid – within 8 days from receipt of goods; any hidden defects shall be reported by the Buyer by writing to the Seller – always in order to be valid – within 8 days as of the relevant discovery. It being understood that the Seller will not be responsible for any defect even though hidden, being notified in writing, after 24 months of the delivery of goods. The warranty does not apply where the defects identified are due to the Buyer's negligence and / or to the use of products being not compliant with the information and explanations in any case gave by the Seller, technical provisions, to incorrect design, application, assembly or manufacture of the facilities in which they are installed, to incorrect maintenance carried out by unauthorized personnel, to improper cleaning since it is made with materials and manners being not suitable, to incorrect storage, handling and transport, to improper or imprudent use, also in the event of electrical system and its capacity being not suitable, or to circumstances that in any case cannot be related to the production defectiveness by the Seller. Every single product of the Seller corresponds to the mark laid down by the European Community with Directive 93 / 68 (extension of Directive 73 / 23) to confirm, with a mark recognized all over Europe, that the lights have undergone the electrical safety test required by European standards EN-60598-1-2 II ed. + CEI EN 60598-1 IV ed. corresponding to Italian standards CEI 34-21 + CEI 34-23, electrical safety standards referred to by all institutions, including the IMQ. The products indicated with the logo UL and / or ETL corresponds to the standards UL 1598 / CAN / USA C22.2 No.250.0 o UL 153.

**Art. 7 Buyer's Obligations**  
The Buyer is required to immediately take delivery of the goods given by the Seller to the carrier, or – where otherwise agreed – to timely collect them at the Seller's plant on the date on which the Seller communicates, by any means, that the goods are ready. Where the Buyer delays the collection of the production for a period exceeding 10 days, in addition to the payment of price it shall pay the Seller a proper compensation equal to 2% per day of the price invoiced for storing such products. The Buyer shall carry out the payments normally, in accordance with the terms and conditions specified in the invoice. For late payments it will be accrued by default without need of further notification interest under Legislative Decree no. 231 / 2002. In the event of payment delays, the Seller is entitled to immediately suspend any supply, even though it has concluded other agreements with the same Buyer. The failure to pay within the terms agreed will cause in any event the loss of favourable terms for the Buyer.

**Art. 8 Replacement of the Product**  
If a product is returned for commercial reasons or for a mistake in the order made by the Buyer, the Seller will retain an amount equal to the 20% of the total price as cost for reconditioning the product. If the returned product had already been used and / or it has been returned in an inadequate original packaging, with consequent transport damages, the Seller will not credit to the Buyer any amount and it will return the product to the sender at his own expenses. Only the articles in the catalogue and in the price list in force at the time of the request will be taken into consideration. Transport's costs are always charged to the Buyer. The repair of damaged products will be authorized only if the damage has been caused by the Buyer. The Buyer, once accepted repair costs, will take care of returning the damaged product to the Seller's warehouse and it will pay the costs of transporting the repaired product.

**Art. 9 Force majeure**  
If the Seller is unable to comply with the agreement due to force majeure or beyond its control events, the deadlines set for the supply are automatically extended for a period in which these effects continue. Where the obstacle to comply with the agreement is longer than 6 months, both parties may request the termination of the agreement and, in such event, the Seller repay the Buyer the advances received, if any, releasing itself from any additional obligation on it.

**Art. 10 Agreement**  
In the event of execution of a specific agreement signed by the parties, the said agreement together with its Annexes provides for and summarizes the obligations validly undertaken by the parties and being binding for them. The fulfilment by the parties will be subject to effective evaluation of the actual performance of the contractual tasks and duties to be carried out in good faith, with honesty and fairness. These General Conditions of Sale shall apply to the agreement, unless otherwise provided in writing by the parties or expressly provided in the said agreement.

**Art. 11 Privacy Policy**  
The Seller will use the data received from the Buyer in accordance with the provisions of the article 13 of EU Regulation 2016 / 679 of 27 April 2016 (GDPR). For more information are available at the following link: [www.lodes.com/privacy-policy](http://www.lodes.com/privacy-policy).

**Art. 12 Disputes**  
Any dispute which may arise concerning the signing, validity, interpretation, performance, amendment and termination of the agreement or of these General Conditions of Sale will be settled according to principles and rule set forth in Article 13 below.

**Art. 13 Jurisdiction and Applicable Law**  
The Court of Milan, Italy, shall be held exclusively competent, being any other court of competent jurisdiction expressly excluded, and the Italian Law shall be applicable.

**Art. 14 Website**  
These General Conditions of Sale are those indicated on the website [www.lodes.com](http://www.lodes.com) and may be printed and reproduced on paper. The Seller undertakes to update the website [www.lodes.com](http://www.lodes.com) by publishing on it the version of the General Conditions of Sale as amended from time to time.

**Art. 1 Premessa**  
Salvo deroga risultante da apposito accordo scritto tra le parti, ogni compravendita di prodotti di Lodes S.r.l., P.IVA 02992370276 (di seguito: “Venditore”) è regolata dalle seguenti Condizioni Generali di Vendita che costituiscono parte essenziale del contratto e che si intendono pertanto accettate dal Compratore ancorché dallo stesso non sottoscritte. Qualsiasi clausola unilateralmente apposta dal Compratore nei documenti da lui sottoscritti e/o nella sua corrispondenza, che sia contraria o comunque in aggiunta alle seguenti condizioni generali od a quelle speciali espressamente approvate per iscritto dal Venditore, si intende come non scritta ed è priva di ogni effetto.

**Art. 2 Perfezionamento della compravendita, quantitativi e prezzi**  
La compravendita si intende perfezionata con la conferma d'ordine scritta del Venditore anche a mezzo fax e/o posta elettronica o con l'inizio delle consegne per i casi in cui è stata richiesta l'immediata consegna della fornitura anche in presenza di modifiche intervenute e quindi accettate dal cliente. I prezzi concordati si intendono per prodotti consegnati franco stabilimento del Venditore e non comprendono prestazioni ed oneri accessori (quali IVA, imballo speciale, spese di trasporto, di installazione e/o montaggi e così via).

**Art. 3 Consegna, trasferimento del rischio e trasporto**  
La merce viene consegnata al Compratore presso lo stabilimento del Venditore o in altro sito dallo stesso indicato per iscritto, ed il trasferimento del rischio avviene con la consegna della stessa al primo vettore o al Compratore nelle ipotesi di ritiro della merce da quest'ultimo direttamente eseguita. La merce viaggia sempre a rischio esclusivo del Compratore anche quando il vettore dovesse essere scelto ed incaricato dal Venditore, essendo quest'ultimo liberato da ogni responsabilità con la consegna dei prodotti al vettore, che ad ogni effetto si intende eseguita a mani dallo stesso Compratore. I termini di consegna pattuiti si intendono indicativi. In caso di ritardo nella consegna imputabile al Venditore per un periodo fino a 60 gg il Compratore non ha il diritto di rifiutare la fornitura, né di richiedere la risoluzione del contratto e/o il risarcimento di alcun danno. Se il ritardo nella consegna supera il termine di 60 gg il Compratore ha la facoltà di richiedere – con lettera raccomandata – l'annullamento dell'ordine e la restituzione degli anticipi eventualmente versati. Resta in ogni caso escluso qualsivoglia obbligo del Venditore di risarcimento danni diretti e/o indiretti di qualsiasi natura e per qualsiasi ragione, in dipendenza del ritardo ovvero della mancata esecuzione della fornitura.

**Art. 4 Riserva di proprietà**  
Il Compratore acquista la proprietà della merce solo con il pagamento integrale del prezzo fatturato delle forniture ma ne assume i rischi dal momento della consegna.

**Art. 5 Caratteristiche dei prodotti e condizioni di utilizzo**  
Salvo diverso ed espresso accordo scritto tra le parti, i parametri funzionali dei prodotti sono quelli espressi comunicati o comunque risultanti nei disegni e specifiche tecniche del Venditore se esistenti o su quanto indicato sul sito web [www.lodes.com](http://www.lodes.com) relativamente ai prodotti. I livelli di qualità dei prodotti forniti sono quelli standard del Venditore, evidenziati nelle relative specifiche o su quanto indicato e desumibile sul sito web del Venditore. È onere del Compratore individuare e comunicare al Venditore le condizioni di utilizzo dei prodotti prima della relativa definizione tecnica. In mancanza di indicazioni da parte del Compratore il Venditore considera condizioni di utilizzo quelle di prassi dallo stesso considerate o esplicitate nei propri disegni e documentazione tecnica. I disegni, i materiali ed i colori dei prodotti inseriti sui cataloghi/sito internet e più in generale in tutto il materiale pubblicitario, si intendono a titolo indicativo. Il Venditore, si riserva il diritto, senza alcun preavviso, di modificare le caratteristiche dei propri prodotti,

così come la disponibilità degli stessi. I dati tecnici, le immagini e le informazioni riguardo ai prodotti non sono vincolanti per il Venditore, il quale non risponderà per eventuali difformità e/o errori illustrativi e/o testuali. Ulteriori caratteristiche dei prodotti sono contenute nelle relative schede tecniche e/o fogli di istruzione.

**Art. 6 Garanzie**  
I prodotti forniti sono coperti da garanzia per difetti di materiale e/o fabbricazione per un periodo di 24 mesi dalla consegna se il Compratore risulta essere una persona fisica, diversamente il periodo di garanzia sarà di 12 mesi dalla consegna. Il Venditore sostituisce i prodotti resi in detto periodo di garanzia e riconosciuti difettosi per vizi d'origine ovvero in alternativa ed a sua scelta accreditata al Compratore una somma pari al prezzo già fatturato dei prodotti stessi, restando espressamente escluso e rinunciato qualsiasi diverso diritto o pretesa del Compratore anche a titolo di risarcimento danni diretti e/o indiretti o di rimborso di costi dallo stesso sostenuti (quali costo di riprese, di assistenza tecnica, di richiamo, ecc.). Il Venditore anticiperà l'invio del prodotto in sostituzione, fatturandolo regolarmente, andando poi ad accreditare l'importo alla riconsegna del prodotto difettoso reso. Le spese di trasporto saranno a carico del Venditore. Qualora l'articolo oggetto del reso venisse riconsegnato in un imballo non originale inadeguato con conseguenti danni da trasporto, il Venditore non accrediterà al Compratore alcun importo e rinverrà al mittente, a sue spese il prodotto. Qualora il reso venisse effettuato per presunti vizi d'origine ma dopo il controllo effettuato dal Venditore lo stesso venisse ritenuto (i) infondato, per assenza di vizi; (ii) ulteriormente danneggiato da insufficiente imballaggio nel trasporto di ritorno (iii) viziato da manomissione posta in essere dal Compratore, verranno addebitati a quest'ultimo tutti i costi di trasporto nonché l'intero valore del prodotto. Eventuali difettosità o non conformità dei prodotti devono essere segnalate dal Compratore per iscritto al Venditore – a pena di decadenza – entro e non oltre 8 gg dalla data di ricevimento della merce; eventuali difetti occulti devono essere segnalati dal Compratore per iscritto al Venditore – sempre a pena di decadenza – entro 8 gg dalla relativa scoperta. Resta inteso che il Venditore non sarà responsabile per alcun vizio ancorché occulto, comunicato per iscritto, oltre 24 mesi dalla consegna della merce. La garanzia non opera ove i difetti rilevati siano imputabili a negligenza del Compratore e/o ad impiego dei prodotti non conforme con le informazioni e le spiegazioni in ogni caso fornite dal Venditore, alle prescrizioni tecniche, ad errata progettazione, applicazione, montaggio o fabbricazione delle strutture ove sono installati, ad errata manutenzione operata da personale non autorizzato, a pulizia impropria in quanto effettuata con modalità o materiali non idonei, ad errato magazzinaggio, movimentazione e trasporto, ad uso improprio od incauto, anche in caso di impianto elettrico e portata dello stesso non idonea, ovvero a circostanze che comunque non possono ricollegarsi a difettosità di produzione da parte del Venditore. Ogni singolo prodotto del Venditore è conforme alla marcatura richiesta dalla Comunità Europea con la direttiva 93/68 (ampliamento della direttiva 73/23) per confermare con una marcatura riconosciuta in tutta Europa, che le lampade sono state sottoposte alle prove di sicurezza elettrica richieste dalle norme Europee EN-60598-1-2 II ed. + CEI EN 60598-1 IV ed. corrispondenti norme italiane CEI 34-21 + CEI 34-23, norme per la sicurezza elettrica a cui fanno riferimento tutti gli istituti, compreso l'IMQ. I prodotti indicati con il marchio UL e/o ETL sono conformi alla normativa UL 1598 / CAN / USA C22.2 No.250.0 o UL 153.

**Art. 7 Obblighi del Compratore**  
Il Compratore è tenuto a prendere immediatamente in consegna i prodotti affidati dal Venditore al vettore, ovvero – se diversamente concordato – apuntualmente ritirarli presso lo stabilimento del Venditore alla data di comunicazione di merce pronta che potrà avvenire con ogni mezzo da parte del Venditore. Ove il Compratore ritardi il ritiro dei prodotti per un periodo superiore a 10 gg, oltre al pagamento del prezzo deve corrispondere al Venditore un adeguato compenso pari al 2% al giorno dell'importo fatturato per il magazzinaggio

degli stessi. Il Compratore deve effettuare i pagamenti normalmente, con le modalità e nei termini precisati in fattura. Sui ritardati pagamenti decorreranno, di pieno diritto e senza necessità di costituzione in mora, gli interessi di cui al D.lgs. n. 231 / 2002. In caso di ritardo dei pagamenti il Venditore ha diritto a sospendere immediatamente ogni fornitura, anche se dipendente da altri contratti con lo stesso Compratore. Il mancato pagamento nei termini pattuiti comporta in ogni caso la decadenza del Compratore dal beneficio del termine.

**Art. 8 Resi**  
In caso di reso commerciale o in caso di reso per errore del Compratore, il Venditore tratterà un importo pari al 20% minimo del totale a titolo di costo di ricondizionamento dell'articolo. Qualora l'articolo oggetto del reso fosse già stato utilizzato e/o venisse riconsegnato in un imballo non originale inadeguato, con conseguenti danni da trasporto, il Venditore non accrediterà al Compratore nessun importo e rinverrà al mittente, a sue spese, il reso. Verranno presi in considerazione solamente gli articoli presenti nel catalogo e nel listino in vigore al momento della richiesta. Le spese di trasporto sono sempre a carico del Compratore. I resi per riparazione vanno autorizzati solo se la causa del danno è dipesa dal Compratore che dopo aver accettato il costo di riparazione si occuperà a proprie spese di rispedire l'articolo danneggiato in sede e si accollerà poi i costi relativi al trasporto del prodotto riparato.

**Art. 9 Forza maggiore**  
Qualora il Venditore sia impossibilitato a rispettare il contratto per cause di forza maggiore o comunque indipendenti dalla sua volontà, i termini previsti per l'esecuzione della fornitura sono automaticamente prorogati per un periodo equivalente al perdurare degli effetti di tali cause. Qualora la causa impeditiva continui per più di 6 mesi entrambe le parti possono chiedere la risoluzione del contratto ed in tal caso il Venditore restituisce al Compratore gli anticipi eventualmente ricevuti, con esclusione di ogni e qualsiasi onere ulteriore a suo carico.

**Art. 10 Contratto**  
In caso di sottoscrizione di apposito contratto lo stesso con i suoi allegati contiene e riassume le obbligazioni validamente assunte dalle parti e per esse vincolanti. L'adempimento delle parti sarà oggetto di valutazione dell'effettiva esecuzione dei compiti e doveri contrattuali, da effettuarsi in buona fede, onestà e con equità. Le presenti Condizioni Generali di Vendita si applicheranno al contratto salvo deroga risultante da atto scritto o in esso contratto esplicitamente prevista.

**Art. 11 Trattamento dei Dati Personali**  
Il Venditore utilizzerà i dati ricevuti dal Compratore conformemente alle disposizioni vigenti in materia di Privacy secondo l'art.13 del Regolamento Europeo 2016 /679 (GDPR). Maggiori informazioni sono disponibili al seguente link [www.lodes.com/it/privacy-policy](http://www.lodes.com/it/privacy-policy).

**Art. 12 Controversie**  
Qualora dovesse verificarsi una qualsivoglia controversia avente ad oggetto la formazione, validità, interpretazione, esecuzione, modifica e risoluzione del contratto o delle presenti Condizioni Generali di Vendita, questa sarà risolta secondo i principi e le regole indicate nell'articolo 13 che segue.

**Art. 13 Foro competente e legge applicabile**  
Foro esclusivamente competente sarà quello di Milano con esplicita esclusione di ogni altro foro alternativamente competente, e la legge applicabile quella italiana.

**Art. 14 Sito Web**  
Le presenti Condizioni Generali di Vendita, sono quelle risultanti sul sito web [www.lodes.com](http://www.lodes.com) e sono stampabili e riproducibili su supporto cartaceo. Il Venditore si impegna ad aggiornare il sito web [www.lodes.com](http://www.lodes.com) mediante la pubblicazione sullo stesso della versione di Condizioni Generali di Vendita di volta in volta modificata.



Head offices & showroom

Lodes, via Pialoi 32,  
30020 Marcon (Venezia) Italy  
T +39 041 45 69 266  
General information  
info@lodes.com

Lodes USA LLC  
560 Springfield Avenue, Suite B  
Westfield, NJ 07090 – USA  
D 201 903 0020  
usa@lodes.com

Lodes' Hong Kong Office  
Unit 507 Arion Commercial  
Centre, 2–12 Queen's Road West  
Sheung Wan, Hong Kong

Lodes Milan showroom

via della Moscova 33,  
Cortile della Seta  
20121 Milano (MI) Italy  
T +39 02 4940 0999  
milano@lodes.com

Lodes Flagships

Lodes Paris  
Novaluce  
131 rue du Faubourg  
Saint Honoré,  
75008 Paris 8e, France  
T +33 (0) 1 42 89 03 18  
paris@lodes.com

Lodes Cologne  
Design Post Köln  
Deutz-Mülheimer-Str. 22a  
50679 Köln, Germany

Lodes 2025

Preview

*Art direction  
and graphic design*  
Multi Form

*Images*  
Operavisual  
Bruger Studio  
(p. 22, 32, 36, 52, 54, 62, 66)

*Photography*  
Mattia Balsamini  
(p. 05–12)

*Copywritings*  
Lodes

*Colour separation*  
Luce Group

*Printing*  
Grafiche Antiga



*Lodes* Preview, PART 1—New Concept: *Oblò design* by Paola Navone—OTTO Studio, *Random Stick design* by Chia—Ying Lee. PART 2—Family Extension: *Volum floor design* by Snøhetta, *Tidal 45 and 75 design* by Needs Studio.