



next[®]
lighting

2017-2018

NEXT LIGHTING – GUTES LICHT IN AUSSERGEWÖHNLICHER FORM

In unserer kleinen Manufaktur in Köln stellen wir mit großer Leidenschaft außergewöhnliche Leuchten her. Ob aus mundgeblasenem Glas, ABS oder PE sie haben alle eines gemeinsam: Ihr Design ist immer einzigartig.

Die Materialien und Komponenten, aus denen wir unsere Leuchten fertigen, suchen wir mit allergrößter Sorgfalt aus. Nachhaltigkeit ist uns ebenso ein Anliegen wie ausgefeilte Technik – unsere Leuchten sind mit der neuesten Technologie ausgestattet und natürlich in LED erhältlich.

Mit ALIEN, BLADE, BLUBB, COSMO & Co. haben wir in den letzten Jahren eine kleine, aber feine und preisgekrönte Leuchtenkollektion auf die Beine gestellt, auf die wir sehr stolz sind.

next-Leuchten sind frisch und unkompliziert und in ihren Einsatzmöglichkeiten nahezu grenzenlos. Und mit dem neuen Montagesystem PLUX für Pendelleuchten immer wieder neu arrangierbar.

ALIEN, BLUBB, CAO MAO und LIQUID_LIGHT gibt es in mehreren Größen. ALIEN, COSMO und LIQUID_LIGHT sind sowohl für Drinnen als auch für Draußen geeignet.

Neu bei next lighting ist die Leuchte BLUBB. Aus mundgeblasenem Glas gefertigt, besticht sie mit einer einfachen, aber ausdrucksstarken Formensprache. Wie alle unsere Leuchten, lässt sich BLUBB wunderbar in zahlreiche Arbeits- und Wohnumgebungen integrieren – als Einzelstück oder in Gruppen.

Viel Freude und Inspiration bei der Suche nach Ihrer perfekten next-Leuchte!

Ihr Thomas Schulte

NEXT LIGHTING – BETTER LIGHTING IN AN EXCEPTIONAL FORM

In our small, Cologne-based workshop we craft exceptional luminaires for you with great passion. Whether they are made from hand-blown glass, ABS or PE – they all have one thing in common: their design is absolutely unique.

The materials and components from which we make our luminaires are selected with the greatest care. Sustainability is as important to us as sophisticated technology – all our luminaires come equipped with the latest technology and are of course available with LEDs.

Over the recent years, we have managed to create a small, excellently crafted and award-winning luminaire collection with models such as ALIEN, BLADE, BLUBB, COSMO and co, which we are very proud of.

next luminaires are fresh, uncomplicated and almost limitless in application. Thanks to our patented PLUX mounting system, the pendant lamps from next are easy to install and can be rearranged over and over again without effort.

ALIEN, BLUBB, CAO MAO and LIQUID_LIGHT are available in a variety of sizes. ALIEN, COSMO and LIQUID_LIGHT can also be used as interior or exterior lighting.

New from next lighting is our luminaire BLUBB. Made from hand-blown glass, it manages to captivate the eye with a simple yet expressive design language. Like all our luminaires, BLUBB can be ideally integrated in a wide range of working or living contexts – either as a single lamp or in groups.

We wish you much joy and inspiration while browsing for the next luminaire which is perfect for you!

Sincerely, Thomas Schulte

Click on **image** for direct link to product.
Back to **INDEX** click 

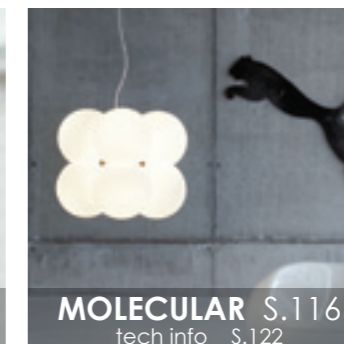
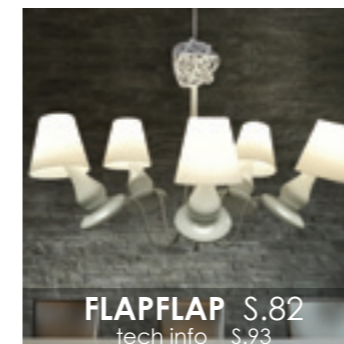
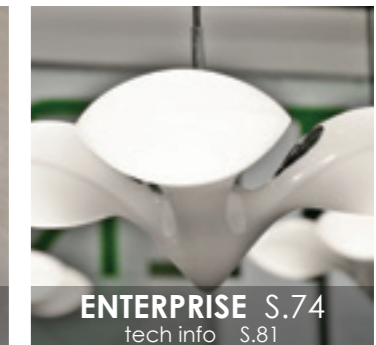
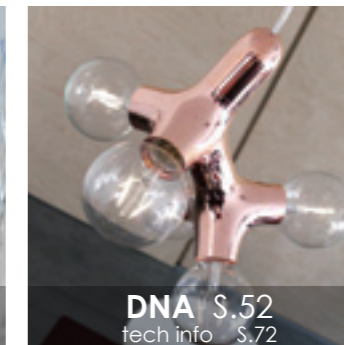
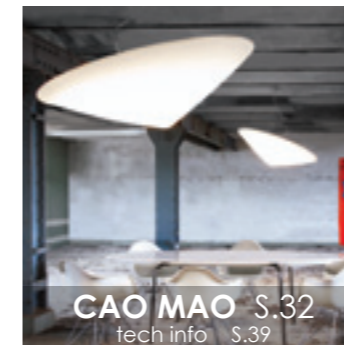
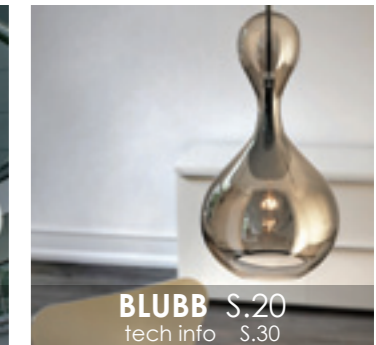
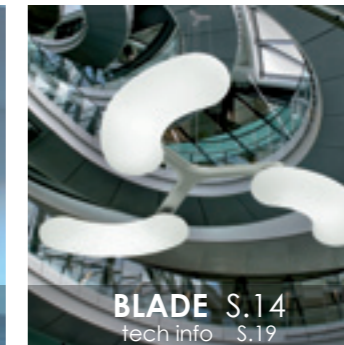



ALIEN_XL_pendant

ALIEN

DESIGN: CONSTANTIN WORTMANN

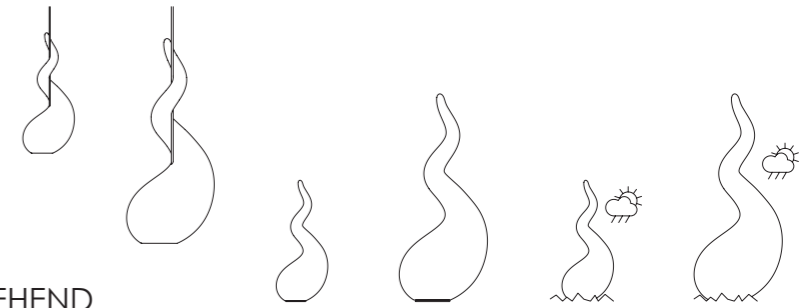

ÜBERALL – KLEIN, GROSS, HÄNGEND, STEHEND
FÜR DRINNEN UND DRAUSSEN

EVERYWHERE – SMALL, LARGE, SUSPENDED, FLOOR
FOR INTERIOR AND EXTERIOR USE



ALIEN_M_pendant



ALIEN_M_pendant





ALIEN_XL_pendant



ALIEN_M_pendant





ALIEN

Material: PE Farbe / colour: weiß / white

Pendelleuchten / pendant lamps:

ALIEN_M

Textilkabel: rot oder silber
Fabric cable: red or silver
Streuscheibe: rot und weiß
Diffusing cap: red and white

Leuchtmittel / lamps:
E27, MAX. 60W, 220-240V

Ⓢ ⒸⒺ Ⓚ Ⓜ IP20

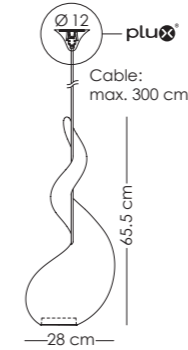

ALIEN_XL

Textilkabel: rot oder silber
Fabric cable: red or silver
Streuscheibe: rot und weiß
Diffusing cap: red and white

Leuchtmittel / lamps:
E27, MAX. 150W, 220-240V

Ⓢ ⒸⒺ Ⓚ Ⓜ IP20

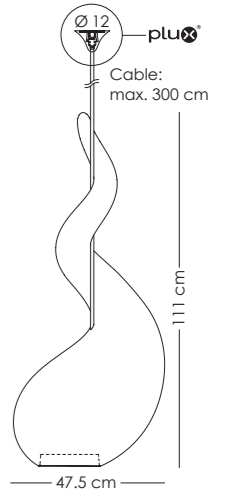

Stehleuchten-Tischleuchten / floor lamps-table lamps:

ALIEN_M easy

Leuchtmittel / lamps:
E27, MAX. 60W, 220-240V
incl. LED Dimmer 85W

Ⓢ ⒸⒺ Ⓚ Ⓜ IP20

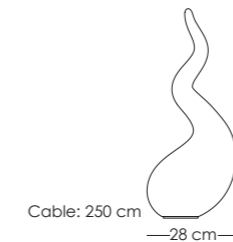

ALIEN_XL easy

Leuchtmittel / lamps:
E27, MAX. 85W, 220-240V
incl. LED Dimmer 85W

Ⓢ ⒸⒺ Ⓚ Ⓜ IP20

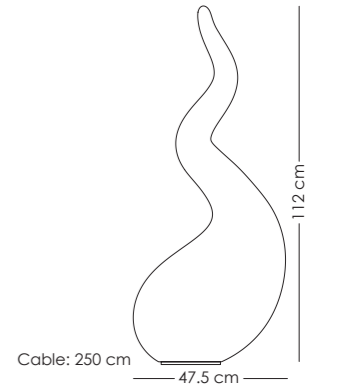

ALIEN_M easy outdoor
wetterfeste Außenleuchte IP33
weatherproof outdoor lamp IP33

Leuchtmittel / lamps:
E27, MAX. 60W, 220-240V

Ⓢ ⒸⒺ Ⓚ Ⓜ IP33

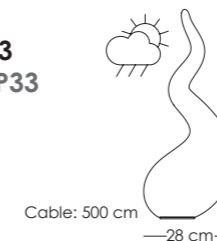

ALIEN_XL easy outdoor
wetterfeste Außenleuchte IP33
weatherproof outdoor lamp IP33

Leuchtmittel / lamps:
E27, MAX. 150W, 220-240V

Ⓢ ⒸⒺ Ⓚ Ⓜ IP33

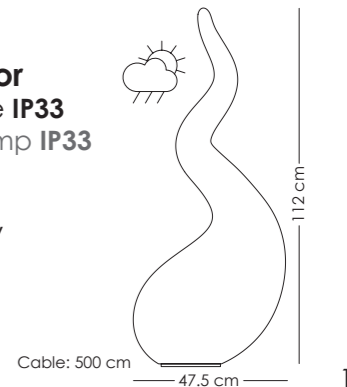



BLADE

DESIGN: J.P. MEULENDIJKS

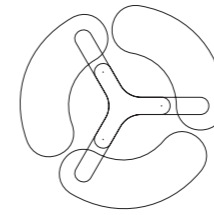

ALLESKÖNNER: TAUSENDSASSA IN 14^3 VARIATIONEN

THE ALL-ROUNDER: JACK OF ALL TRADES IN 14^3 VARIATIONS







BLADE

Material: PE, Aluminium

Farbe / colour: weiß / white

Leuchtmittel / lamps:

LED Modul 152,4W, 220-240V, 50-60Hz

3000K, 21.690lm

4000K, 22.890lm

Dimmbar / dimmable: DALI / PUSH

Ⓞ Ⓢ Ⓜ Ⓡ Ⓢ Ⓡ IP20

SONSTIGES / OTHER:

LEUCHTKÖRPER STUFENLOS VERSTELLBAR
SONDERLÄNGEN AUF ANFRAGE

ROTATABLE SHADES:

ADJUSTABLE TO MULTIPLE POSITIONS

OVERLENGTH ON REQUEST

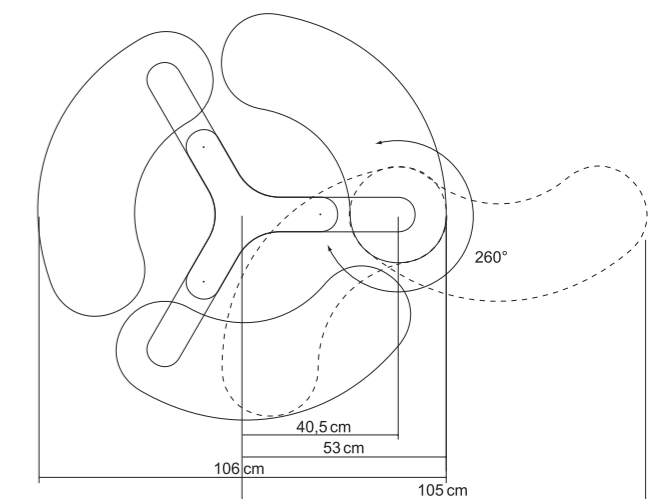
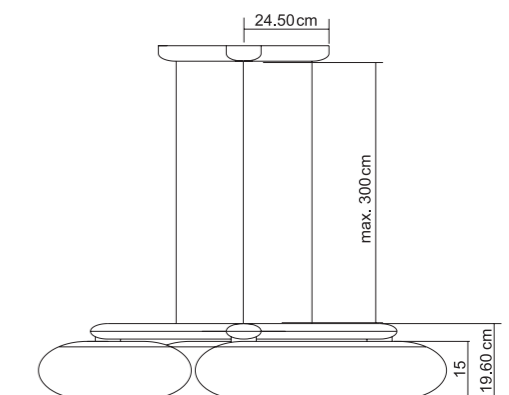



BLUBB

DESIGN: CONSTANTIN WORTMANN, BÜRO FÜR FORM

MUNDGEBLASENER EINZELGÄNGER
ABER AUCH GERNE IN GRUPPEN GESEHEN

HAND-BLOWN INDIVIDUALIST
BUT ALSO LIKES TO HANG OUT IN GROUPS

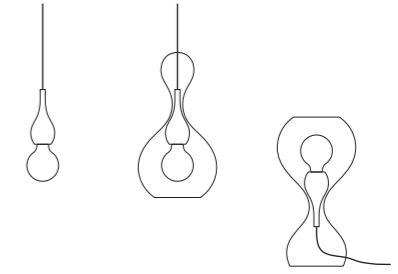

BLUBB_pendant_chrome



BLUBB_pendant_clear



BLUBB_pendant_opal



BLUBB_pendant_green



BLUBB_pendant_clear





BLUBB_table_opal



BLUBB_table_clear



BLUBB_table_green



BLUBB_table_chrome



BLUBB_table_green-opal-chrome



BLUBB_mini_white-black



BLUBB_mini_recessed_version



BLUBB

Material: Glas / glass

Farben / colours:

Schirm / shade: klar, opal, grün, chrom / clear, opal, green, chrome

Innenschirm / inner shade: opal, schwarz / opal, black

Textilkabel / fabric cable: rot, silber, schwarz / red, silver, black

Baldachin / canopy: weiß, schwarz / white, black

Pendelleuchten / pendant lamps:

BLUBB_pendant

Leuchtmittel / lamps:

E27, MAX. 20W, 220-240V

© CE □ ▽ IP20

BLUBB_mini

Leuchtmittel / lamps:

E27, MAX. 20W, 220-240V

© CE □ ▽ IP20

SONSTIGES / OTHER:

OPTIONAL MIT PLUX, DECKENEINBAU
ODER OHNE BALDACHIN.

OPTINAL WITH PLUX, RECESSED
VERSION OR WITHOUT CANOPY.

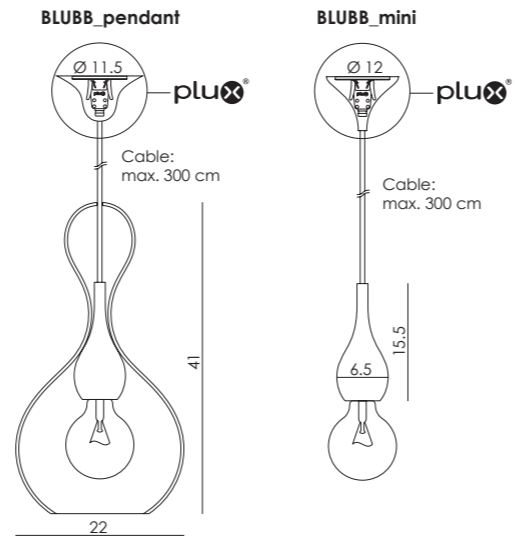

Tischleuchte / table lamp:

BLUBB_table

Leuchtmittel / lamps:

E27, MAX. 20W, 220-240V

© CE □ ▽ IP20

SONSTIGES / OTHER:

INCL. LED DIMMER

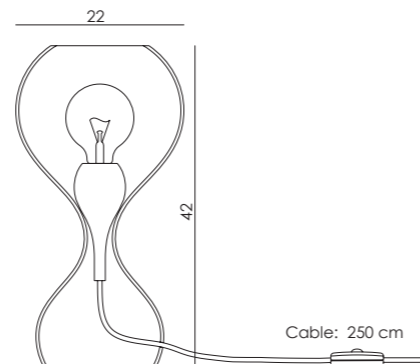

Alle Versionen / all versions:

BLUBB_pendant

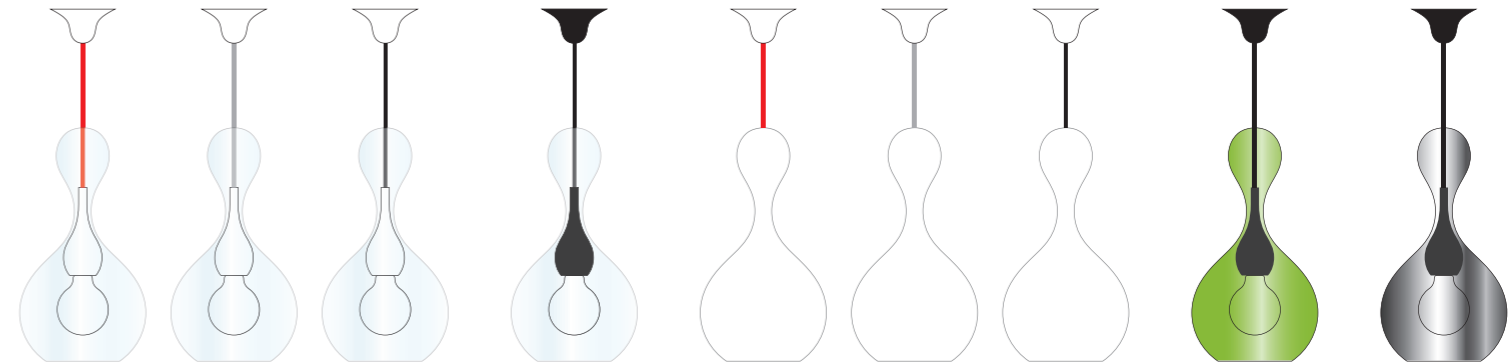

BLUBB_mini

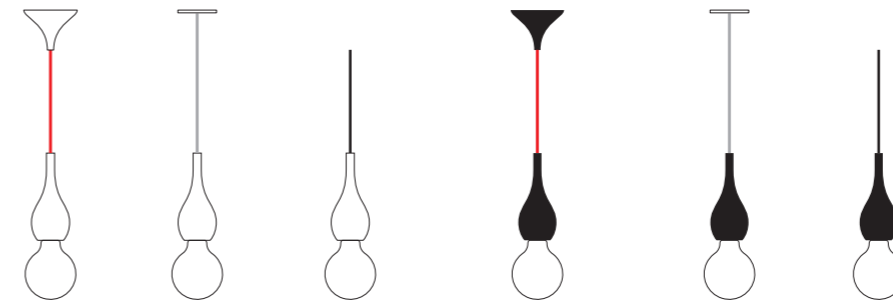

Optional mit PLUX, Deckeneinbau oder ohne Baldachin.
Optinal with PLUX, recessed version or without canopy.

BLUBB_table

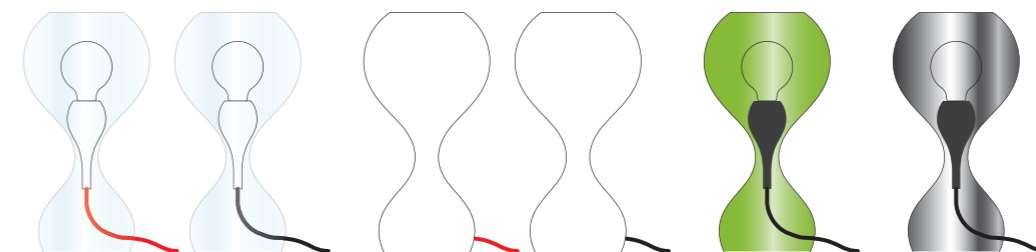



CAO MAO

Design: HOPF & WORTMANN, BÜRO FÜR FORM

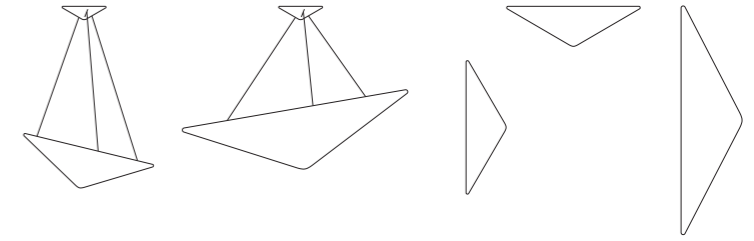

DIMMBARER REISHUT IN ZWEI GRÖSSEN
STUFENLOS HÖHENVERSTELLBAR UND NEIGBAR

DIMMABLE COOLIE HAT IN TWO SIZES
INCLINABLE AND INFINITELY ADJUSTABLE IN HEIGHT



CAO MAO_120_pendant

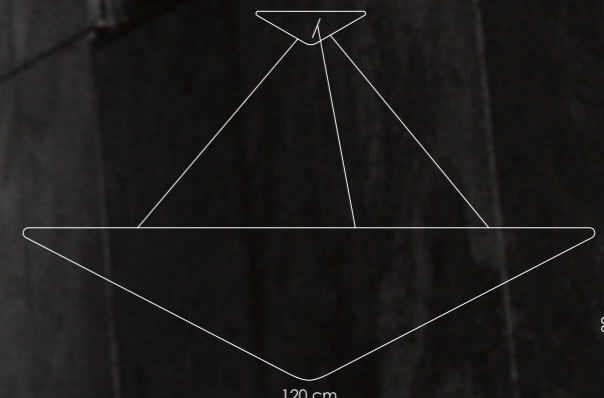

32 cm

120 cm

CAO MAO_120_pendant



CAO MAO_70_pendant



CAO MAO_70_wall / ceiling



CAO MAO_120_wall



CAO MAO_120_pendant



37



CAO MAO

Material: PE Farbe / colour: weiß / white

Pendelleuchten / pendant lamps:

CAO MAO_70

Leuchtmittel / lamps:
LED Modul 27,6W, 110-240V,
50-60Hz

3000K, 4.120lm
4000K, 4.430lm

Dimmbar / dimmable:
DALI / PUSH / 1-10V

CE IP20

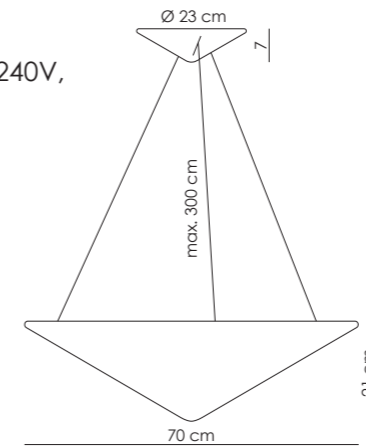

CAO MAO_120

Leuchtmittel / lamps:
LED Modul 66W, 220-240V,
50-60Hz

3000K, 9.760lm
4000K, 10.550lm

Dimmbar
dimmable:
DALI / PUSH

CE IP20

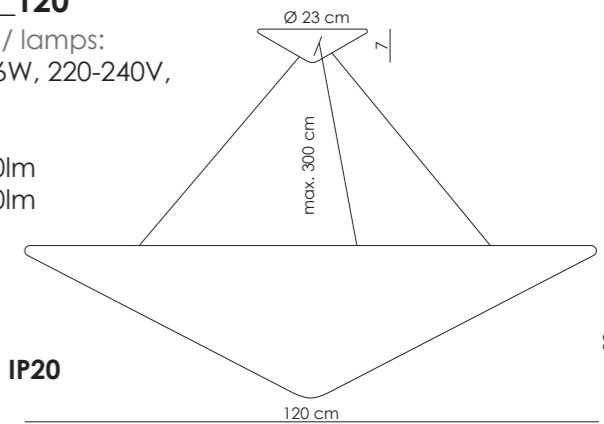

Wandleuchten-Deckenleuchte / wall lamps-ceiling lamp:

CAO MAO_70 wall-ceiling

Leuchtmittel / lamps:
LED Modul 27,6W, 110-240V,
50-60Hz

3000K, 4.120lm
4000K, 4.430lm

Dimmbar
dimmable:
DALI / PUSH / 1-10V

CE IP20

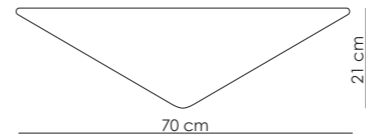

CAO MAO_120 wall

Leuchtmittel / lamps:
LED Modul 66W, 220-240V,
50-60Hz

3000K, 9.760lm
4000K, 10.550lm

Dimmbar / dimmable:
DALI / PUSH

CE IP20

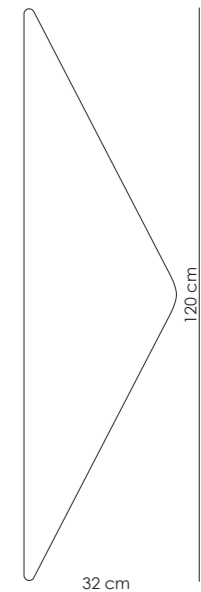

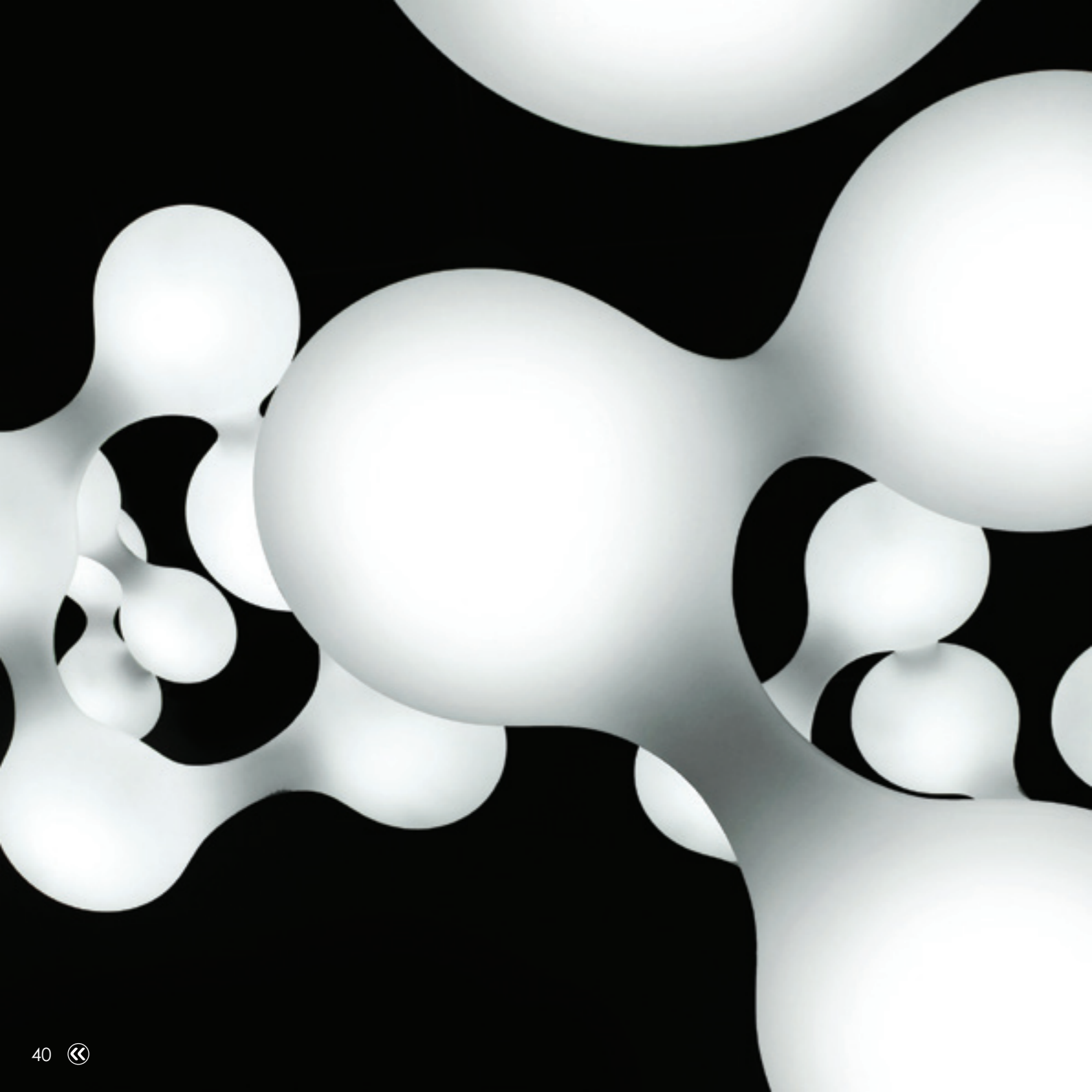

COSMO

DESIGN: CONSTANTIN WORTMANN, BÜRO FÜR FORM

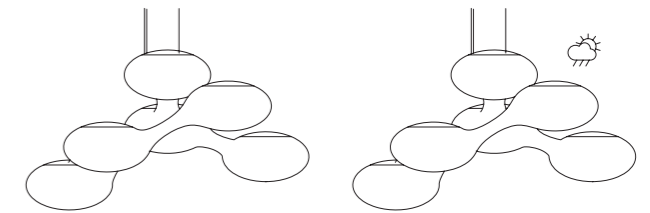

ENERGIEEFFIZIENTE WOLKE MIT FULMINANter WIRKUNG
FÜR DRINNEN UND DRAUSSEN

ENERGY EFFICIENT CLOUD WITH SPECTACULAR RESULTS
FOR INTERIOR AND EXTERIOR USE



COSMO



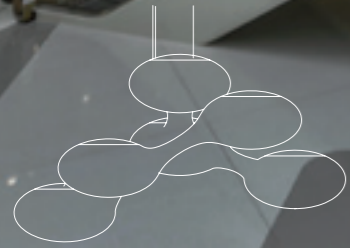

88 cm

Ø 160 cm









COSMO

Material: PE

Farbe / colour:

Leuchtkörper / shade: weiß / white

Kappen / caps: silber / silver

COSMO_LED

Leuchtmittel / lamps:

LED Modul 6 x 19,6W

220-240V, 50-60Hz

3000K, 6 x 2.830lm

4000K, 6 x 3.100lm

Dimmbar / dimmable: DALI / DSI / SWITCH

Ⓢ CE Ⓡ IP40

COSMO_LED outdoor IP44

Leuchtmittel / lamps:

LED Modul 6 x 19,6W

220-240V, 50-60Hz

3000K, 6 x 2.830lm

4000K, 6 x 3.100lm

Dimmbar / dimmable: DALI / DSI / SWITCH

Ⓢ CE Ⓡ IP44

COSMO_LED RGBW

Leuchtmittel / lamps:

LED Modul 6 x 29,5W

220-240V, 50-60Hz

4000K, 6 x 3.100lm

Dimmbar / dimmable: DALI / KNX / DMX

Ⓢ CE Ⓡ IP40

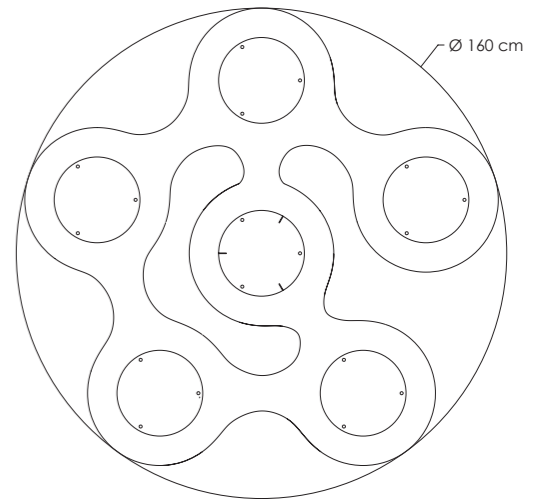
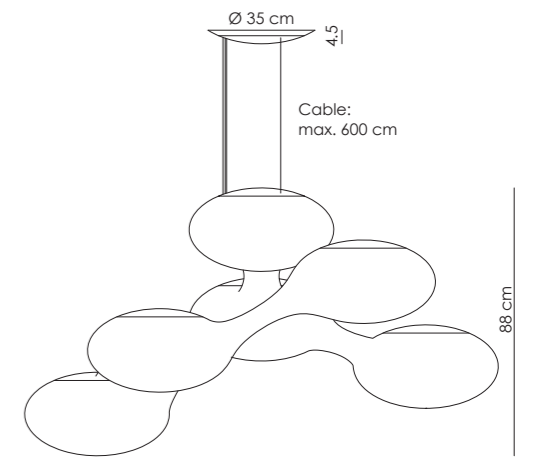

interior
innovation
award
2014

Selection

Leuchte
des Jahres 2013



DNA_double_copper

DNA

DESIGN: HOPF & WORTMANN BÜRO FÜR FORM

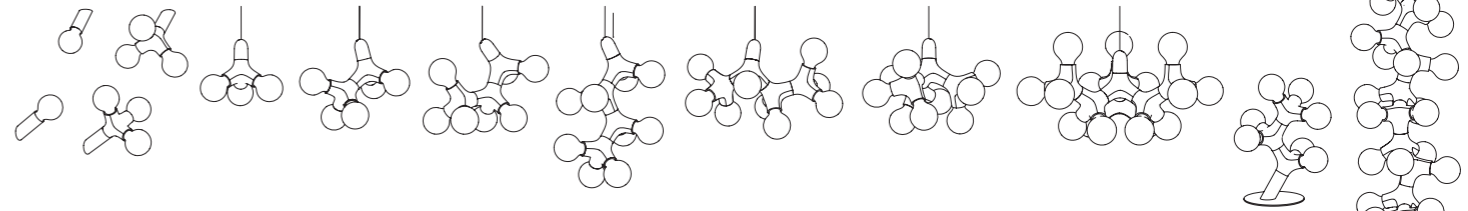

SOLIST ODER EXZESSIVES LICHTOBJEKT
ZEIGT SICH VORZUGSWEISE IN WEISS, SCHWARZ, KUPFER ODER CHROM

SOLOIST OR EXTRAVAGANT LIGHTING OBJECT
PREFERABLY APPEARS IN WHITE, BLACK, COPPER OR CHROME



DNA_chandelier XL_black



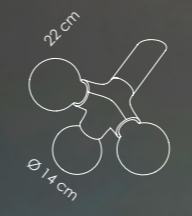

DNA_wall / ceiling



DNA_wall / ceiling_easy

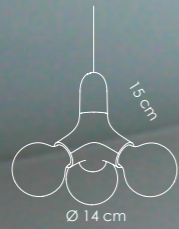

DNA_single_chrome



DNA_double_black

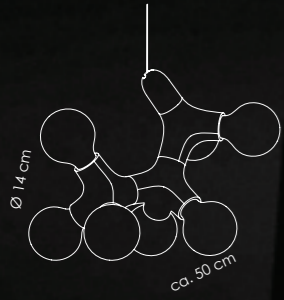

DNA_triple_black

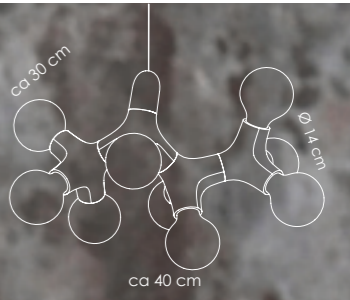

DNA_0,1,2_copper

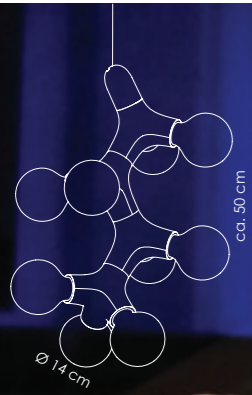

DNA_quattro_copper



DNA_chandelier_chrome

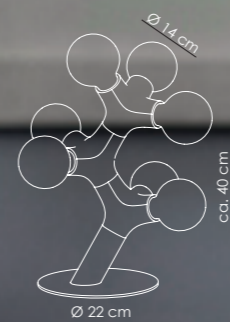
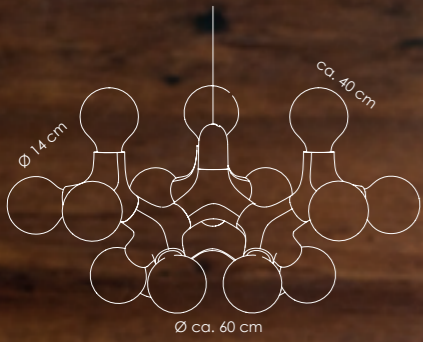



DNA_table_black



DNA_table_copper



DNA_individual

Individuelle DNA-Konfigurationen nach Kundenwunsch

Technische und gestalterische Beratung bei der Konfiguration von Maßanfertigungen

customer-specific configurations of DNA

technical and design advice for the configuration of tailor-made solutions available



DNA_chandelier XXL_chrome

DNA

Material: ABS

Farbe: weiß, schwarz, kupfer, chrom

Colour: white, black, copper, chrome

CE IP20

Pendelleuchten / pendant lamps:

DNA_single

Leuchtmittel / lamps:
1 x E27, MAX. 28W, 220-240V

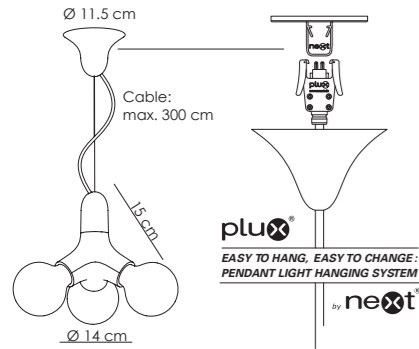

DNA_double

Leuchtmittel / lamps:
5 x E27, MAX. 28W, 220-240V

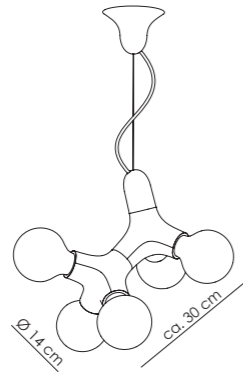

DNA_triple

Leuchtmittel / lamps:
7 x E27, MAX. 28W, 220-240V

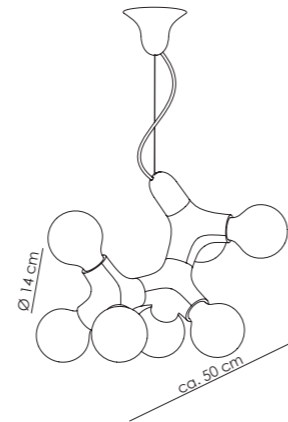

DNA_chandelier XL

Leuchtmittel / lamps:
15 x E27, MAX. 28W, 220-240V

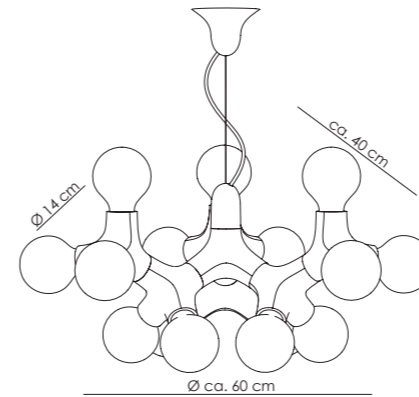

DNA_individual

Leuchtmittel / lamps:
X x E27, MAX. 28W, 220-240V

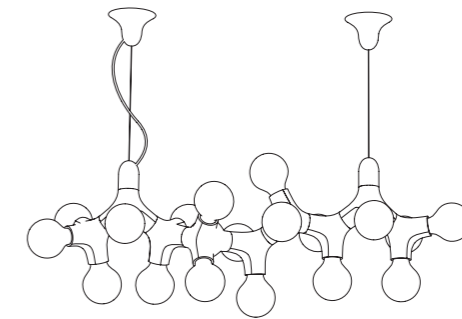

2 mögliche Beispiele / 2 possible examples

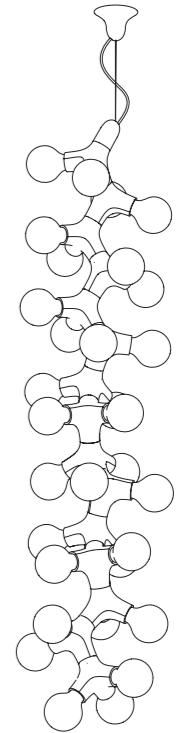

DNA_quattro

Leuchtmittel / lamps:
9 x E27, MAX. 28W, 220-240V

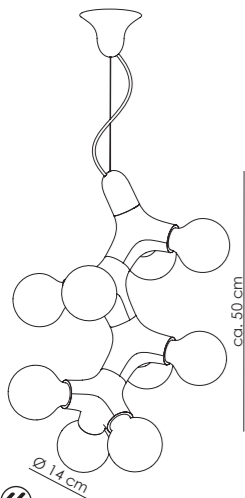

DNA_0,1,2

Leuchtmittel / lamps:
9 x E27, MAX. 28W, 220-240V

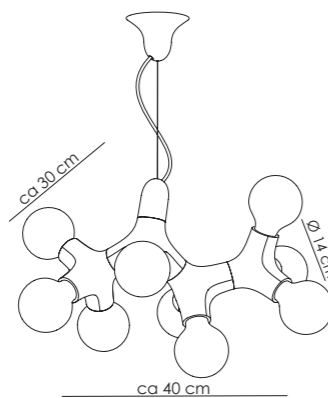

DNA_chandelier

Leuchtmittel / lamps:
9 x E27, MAX. 28W, 220-240V

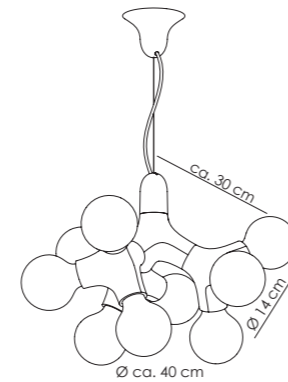

Tischleuchte / table lamp:

DNA_table

Leuchtmittel / lamps:
7 x E27, MAX. 6W, 220-240V

SONSTIGES / OTHER:
INCL. LED - DIMMER
TEXTILKABEL
FABRIC CABLE

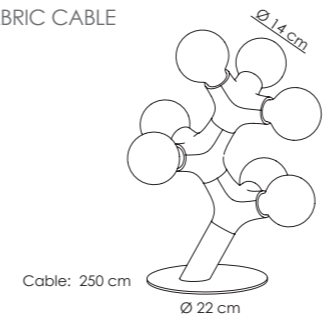

Wandleuchten-Deckenleuchten / wall lamps-ceiling lamps:

DNA_wall-ceiling

Leuchtmittel / lamps:
3 x E27, MAX. 28W, 220-240V

SONSTIGES / OTHER:
OPTIONAL: MIT MONTAGEPLATTE
OPTIONAL: WITH MOUNTING PLATE

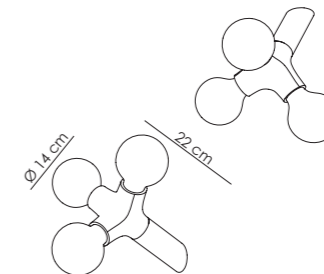

DNA_wall-ceiling-easy

Leuchtmittel / lamps:
1 x E27, MAX. 28W, 220-240V

SONSTIGES / OTHER:
OPTIONAL: MIT MONTAGEPLATTE
OPTIONAL: WITH MOUNTING PLATE

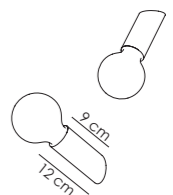



ENTERPRISE

DESIGN: CONSTANTIN WORTMANN, BÜRO FÜR FORM

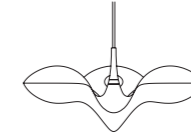

INVASION AUS DEM ALL
ABGESEILT IN ROT, BRAUN ODER SILBERFARBEN

INVASION FROM OUTER SPACE
ROPES DOWN ON CORDS OF RED, BROWN OR SILVER



ENTERPRISE_chrome_red







ENTERPRISE

Material: PE, Aluminium, Holz / PE, aluminium, wood

Farben / colours:

Schirm / shade: weiß / white

Kappen / caps: Chrom, Kupfer / chrome, copper

Ring: Holz, Kupfer, rotes Acryl / wood, copper, red acryl

Textilkabel: braun, silber, rot

Fabric cable: brown, silver, red

Leuchtmittel / lamps:

E14, 3 x 7W LED, 3 x 400lm

⊙ CE □ ▽ IP40

SONSTIGES / OTHER: INKLUSIVE LED LEUCHTMITTEL / LED LAMPS INCLUDED

Alle Versionen / all versions:

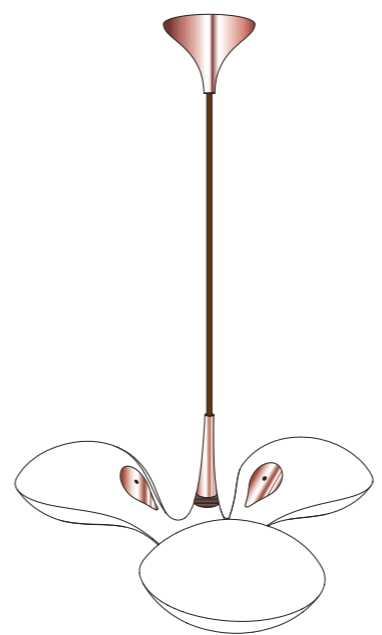
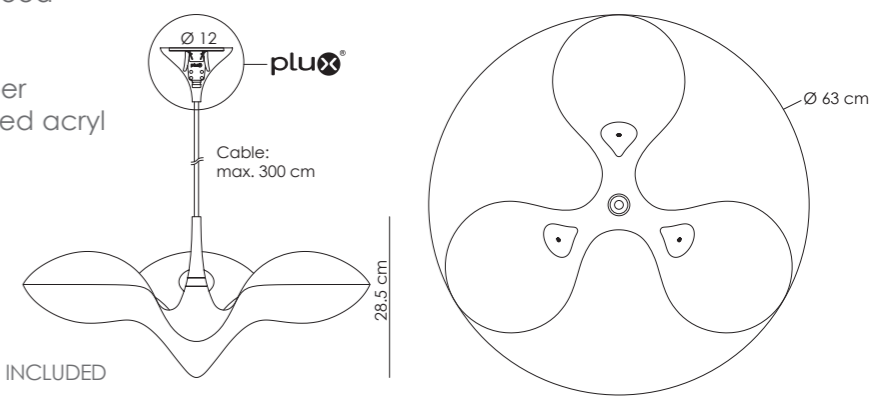

“copper - wood“
Kappe / cap:
 Kupfer / copper
Ring:
 Holz / wood
Kabel / cable:
 braun / brown
Baldachin / canopy:
 Kupfer / copper

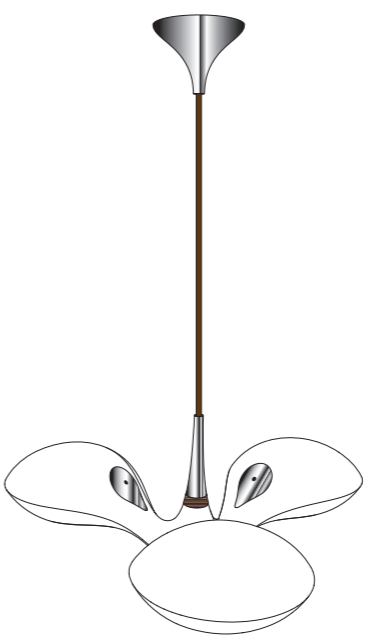

“chrome - wood“
Kappe / cap:
 Chrom / chrome
Ring:
 Holz / wood
Kabel / cable:
 braun / brown
Baldachin / canopy:
 Chrom / chrome

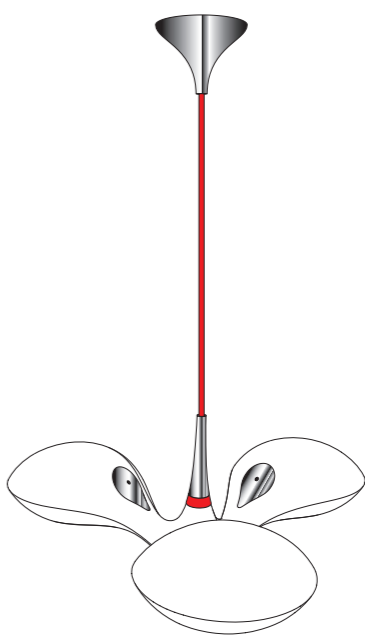

“chrome - red“
Kappe / cap:
 Chrom / chrome
Ring:
 rotes Acryl / red acryl
Kabel / cable:
 rot / red
Baldachin / canopy:
 Chrom / chrome



“chrome - chrome“
Kappe / cap:
 Chrom / chrome
Ring:
 Chrom / chrome
Kabel / cable:
 silber / silver
Baldachin / canopy:
 Chrom / chrome



FLAPFLAP

DESIGN: CONSTANTIN WORTMANN, BÜRO FÜR FORM

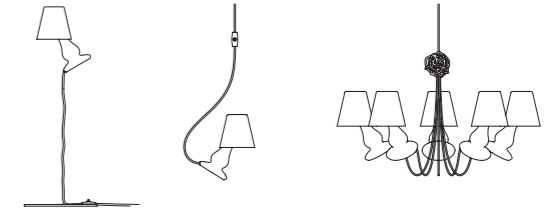

NOSTALGIE RELOADED – NONCHALANT VON DER DECKE,
EGOZENTRISCH AM BODEN

NOSTALGIA RELOADED – DEBONAIR IN THE AIR,
ECCENTRIC AT GROUND LEVEL



FLAPFLAP_floor (on a pile of cables)



FLAPFLAP_single_pendant



AUSZEICHNUNGEN / AWARDS:

THE INTERNATIONAL DESIGN YEARBOOK 2001, BY M. DE LUCCHI
FORM 2001 AWARD,
VICTORIA & ALBERT MUSEUM, „BRILLIANT EXHIBITION“, LONDON
BADISCHES LANDESMUSEUM, KARLSRUHE
MUSEUM FÜR KUNST UND GEWERBE, HAMBURG









FLAPFLAP_chandelier

FLAPFLAP

Material: ABS, Stahl / steel
Farbe / colour: weiss / white

Tischleuchte-Bodenleuchte Table lamp-floor lamp:

FlapFlap_floor

Leuchtmittel / lamps:
 1 x E14, MAX. 40W, 220-240V
 ○ CE □ ▽ IP20

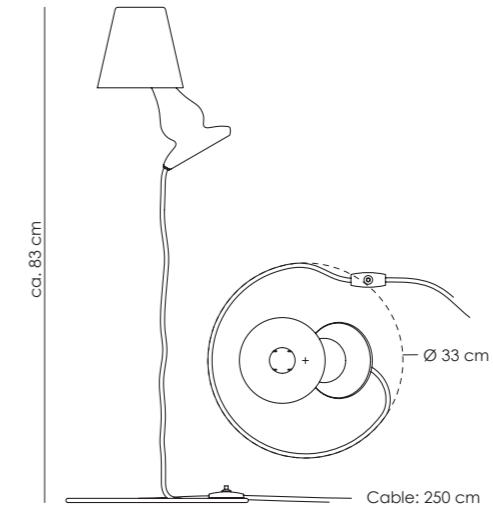

Pendelleuchten / pendant lamps:

FlapFlap_single pendant

Leuchtmittel / lamps:
 1 x E14, MAX. 40W, 220-240V
 ○ CE □ ▽ IP20

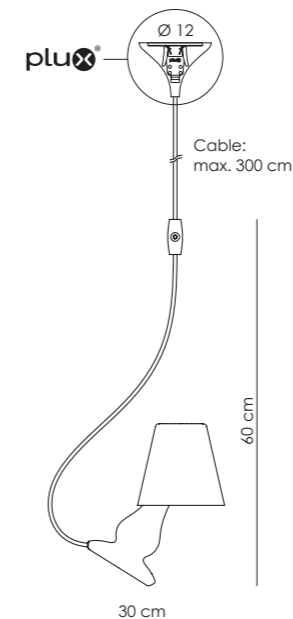

FlapFlap_chandelier

Leuchtmittel / lamps:
 5 x E14, MAX. 40W, 220-240V
 ○ CE □ ▽ IP20

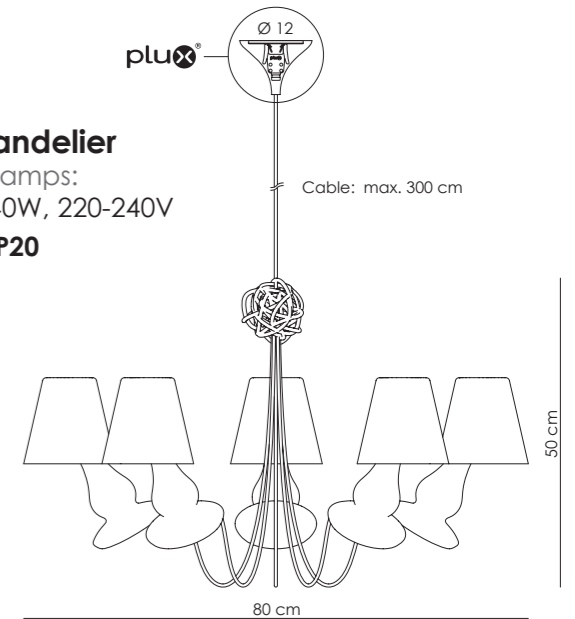



LIQUID_LIGHT

DESIGN: HOPF & WORTMANN, BÜRO FÜR FORM

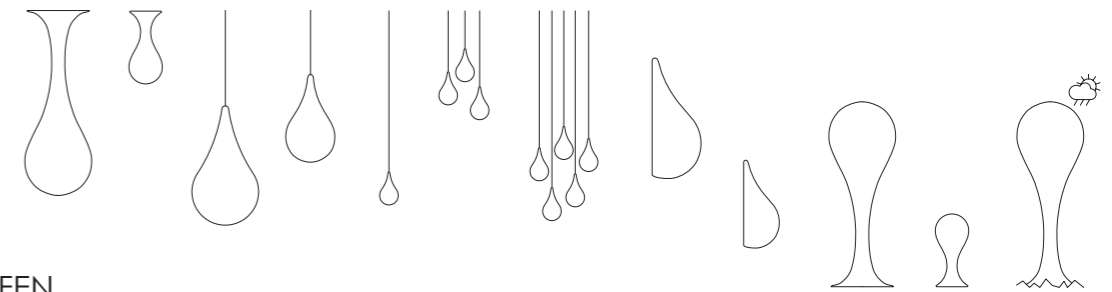

PREISGEKRÖNTE TROPFEN
IN MEHREREN GRÖSSEN ERHÄLTlich

AWARD-WINNING DROPS
AVAILABLE IN VARIOUS SIZES





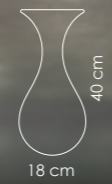

DROP_1_small







27 cm

47 cm





DROP_2 xs_single_recessed version



DROP_2 xs_5



DROP_2 xs_5 long



DROP_2 xs_3



AUSZEICHNUNGEN / AWARDS:

“FORM 2001” , INT. FURNITURE FAIR COLOGNE

“DESIGN FOR EUROPE, BEST LIGHTING” ,
BIENNALE KORTRIJK, BELGIUM

AUSTELLUNGEN / EXHIBITIONS:

“DESIGN DEUTSCHLAND CASE STUDY 08”
NEUES MUSEUM FÜR KUNST & DESIGN, NÜRNBERG

“SKIN”
COOPER HEWITT NATIONAL DESIGN MUSEUM,
NEW YORK, USA

“MOOD RIVER”
WEXNER CENTER FOR THE ARTS, OHIO, USA

BÜCHER / BOOKS:

“DESIGNING THE 21ST CENTURY”
EDITED BY PETER & CHARLOTTE FIELL
TASCHEN VERLAG

“DESIGNERS ON DESIGN”
PUBLISHED BY TERENCE CONRAN & MAX FRASER
CONRAN OCTOPUS LTD.

“ZOO 09” BY WILL GOMPERTZ
PURPLE HOUSE LIMITED, LONDON

“1000 LIGHTS” BY PETER & CHARLOTTE FIELL
TASCHEN VERLAG





DROP_4



DROP_4_outdoor



LIQUID_LIGHT

Material: PE Farbe / colour: weiß/ white

Deckenleuchten / ceiling lamps:

DROP_1

Leuchtmittel / lamps:
E27, MAX. 100W, 220-240V

CE IP20

SONSTIGES / OTHER:
EINFACHE MONTAGE MITTELS BAJONETTVERSCHLUSS
KABELAUSGÄNGE FÜR REIHENSCHALTUNG
EASY INSTALLATION WITH BAYONET JOINT
CABLE OUTLETS FOR SERIAL CONNECTION

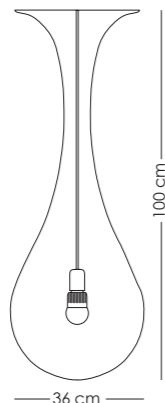

DROP_1 small

Leuchtmittel / lamps:
E14, MAX. 33W, 220-240V

CE IP20

SONSTIGES / OTHER:
EINFACHE MONTAGE MITTELS BAJONETTVERSCHLUSS
KABELAUSGÄNGE FÜR REIHENSCHALTUNG
EASY INSTALLATION WITH BAYONET JOINT
CABLE OUTLETS FOR SERIAL CONNECTION



Wandleuchten / wall lamps:

DROP_3

Leuchtmittel / lamps:
E27, MAX. 70W, 220-240V

CE IP20

SONSTIGES / OTHER:
SEHR EINFACHE MONTAGE
KABEL MIT SCHALTER
EASY INSTALLATION
CORD WITH SWITCH

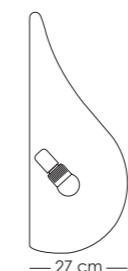

DROP_3 small

Leuchtmittel / lamps:
E27, MAX. 70W, 220-240V

CE IP20

SONSTIGES / OTHER:
SEHR EINFACHE MONTAGE
KABEL MIT SCHALTER
EASY INSTALLATION
CORD WITH SWITCH

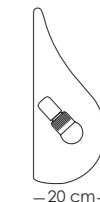

Pendelleuchten / pendant lamps:

DROP_2

Leuchtmittel / lamps:
E27, MAX. 100W, 220-240V

CE IP20

SONSTIGES / OTHER:
ÜBERLÄNGEN AUF ANFRAGE
OVERLENGTH ON REQUEST

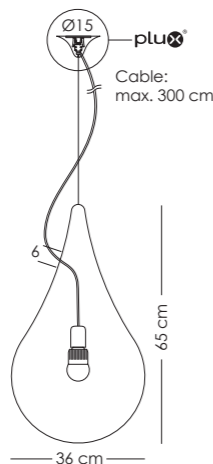

DROP_2 small

Leuchtmittel / lamps:
E27, MAX. 100W, 220-240V

CE IP20

SONSTIGES / OTHER:
ÜBERLÄNGEN AUF ANFRAGE
OVERLENGTH ON REQUEST

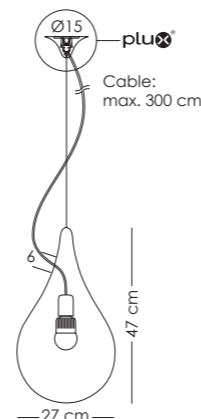

Stehleuchte / floor lamp:

DROP_4

Leuchtmittel / lamps:
E27, MAX. 85W, 220-240V

CE IP20

SONSTIGES / OTHER:
INCL LED DIMMER

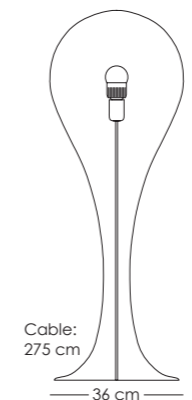

Tischleuchte / table lamp:

DROP_4 small

Leuchtmittel / lamps:
E14, MAX. 33W, 220-240V

CE IP20

SONSTIGES / OTHER:
KABEL MIT SCHALTER
CORD WITH SWITCH

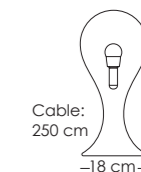

DROP_2 xs

Leuchtmittel / lamps:
Jeder / each DROP:
G4, 2,5W, 220-240V
3000K, 200lm

CE IP40

SONSTIGES / OTHER:
INKLUSIVE LED TREIBER UND
LED LEUCHTMITTEL
LED BALLAST AND LED LAMP
INCLUDED

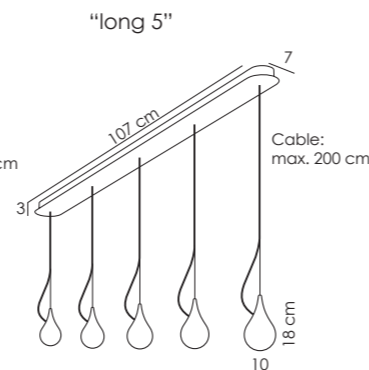
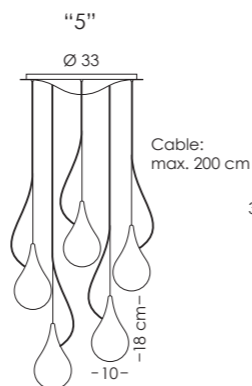
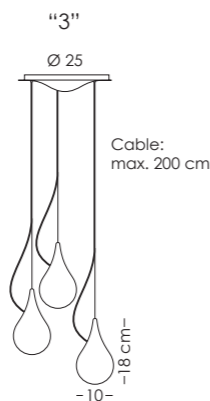
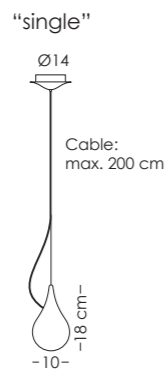
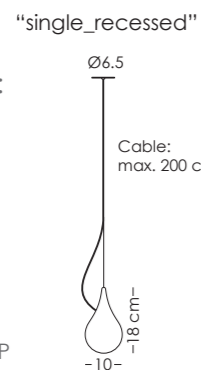

Wetterfeste Außenleuchte / weatherproof outdoor lamp:

DROP_4 outdoor

Leuchtmittel / lamps:
E27, MAX. 100W, 220-240V

CE IP43

SONSTIGES / OTHER:
FESTE VERANKERUNG IM BODEN DURCH
ZWEI METALLSPITZEN. / SECURLY FIXED IN
THE GROUND BY TWO METAL POLES.

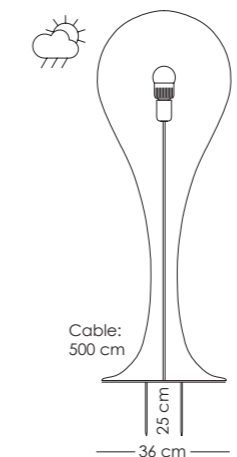



ML_3_installation - outer edge & ML_2_installation - edge

MOLECULAR_LIGHT

DESIGN: HOPF & WORTMANN, BÜRO FÜR FORM

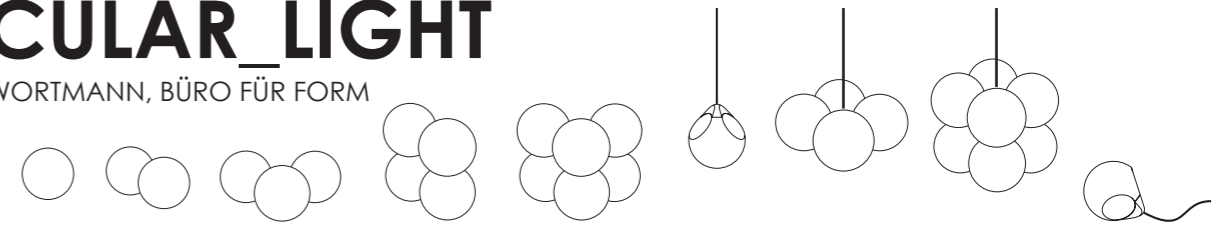

ECKEN UND KANTEN BEVORZUGT
LEUCHTKUGELN FÜR ANDERSDENKER

SQUARING THE CIRCLE
GLOW BALL FOR THE DIFFERENT-MINDED



MOLECULAR_LIGHT_family



ML_2_installation - edge

ML_1_installation - corner



ML_6_installation - outer edge



ML_2_installation - edge



ML_4_installation - wall



ML_1_easy



ML_4_pendant



ML_8_pendant

MOLECULAR_LIGHT

Material: PE

Farbe / colour: weiß / white

Leuchtmittel / lamps: E27, MAX. 28W, 220-240V

CE IP20

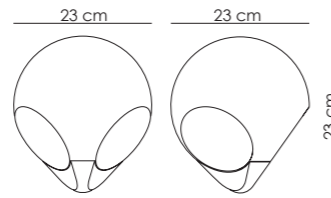

Wandleuchten-Deckenleuchten / wall lamps-ceiling lamps:

ML_1 Montage / installation

Für Raumecken / for roomcorners

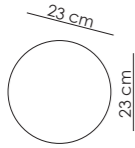

ML_2 Montage / installation

Für Raumkanten / for roomedges

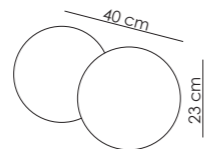

ML_3 Montage / installation

Für Raumaussenkanten
for outer roomedges

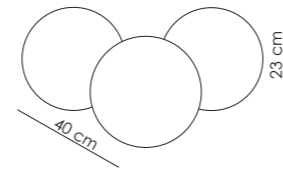

ML_4 Montage / installation

Für Wand - Decke / for wall - ceiling

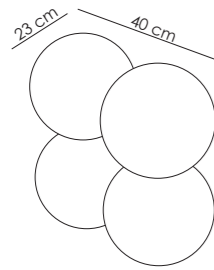

ML_6 Montage / installation

Für Raumaussenkanten
for outer roomedges

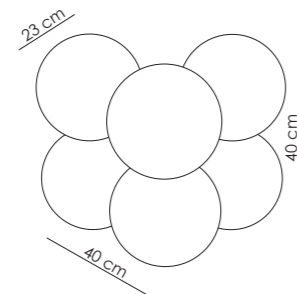

Pendelleuchten / pendant lamps:

ML_1 Pendel / pendant

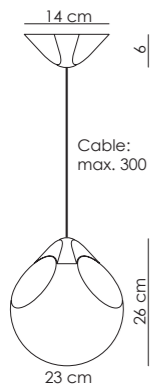

ML_4 Pendel / pendant

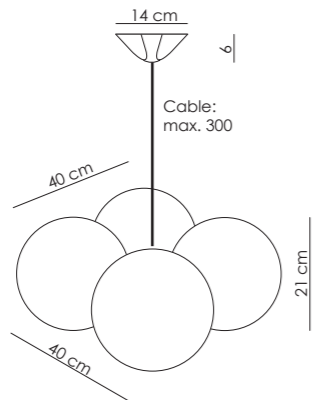

ML_8 Pendel / pendant

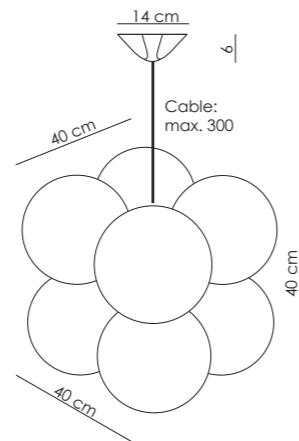

Tischleuchte-Bodenleuchte table lamp-floor lamp:

ML_1 easy

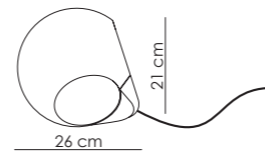

Montage in Raumecken, Rauminnenkanten und an Raumaußenkanten
Install in corners and in and around room edges.

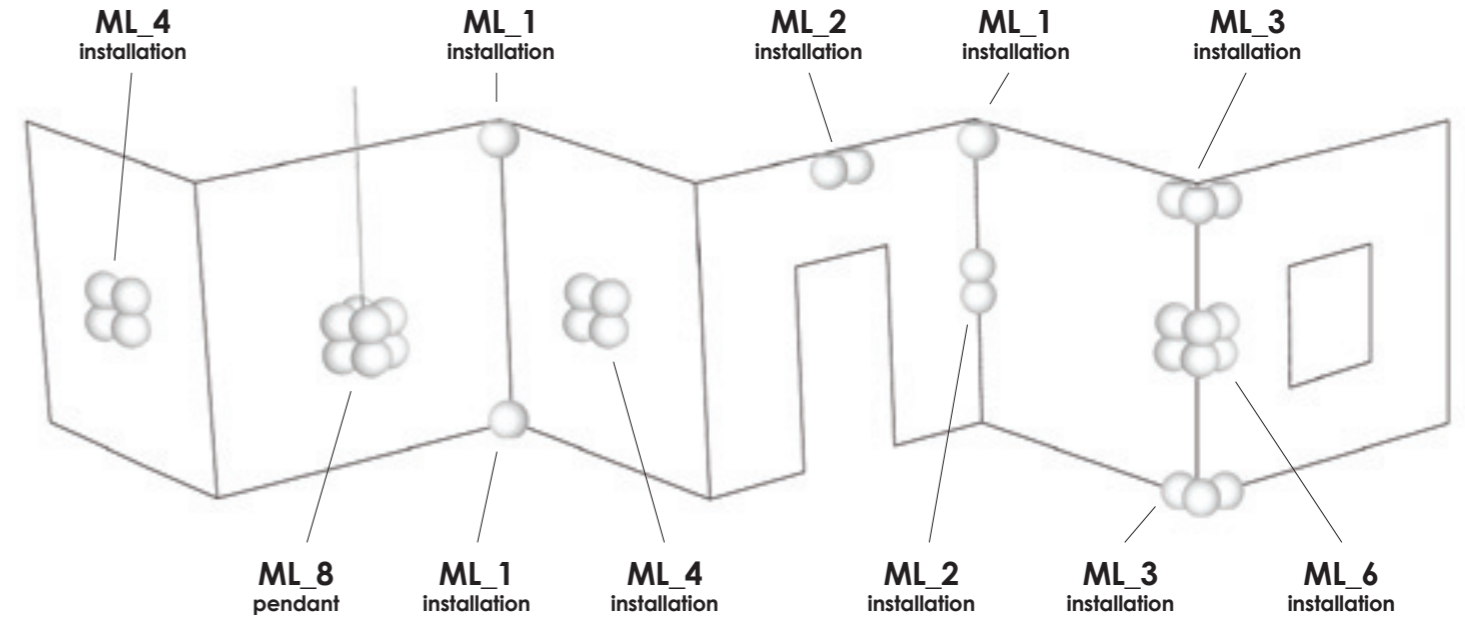

Einfache Verbindung und Montage
Easy connection and installation

Designpreise / designawards:



DESIGN PLUS



Patent N° 10 2012 006 164

PLUX

PENDANT LIGHT HANGING SYSTEM BY **next** LIGHTING

EINSTÖPSELN, AUSSTÖPSELN, UMSTÖPSELN

PLUG IT IN, PLUG IT OUT, PLUG IT ALL AROUND

EASY TO HANG – EASY TO CHANGE – WELCOME TO THE NEXT FAMILY

Patentiertes Stecksystem zur Deckenmontage von Pendelleuchten: Einfaches Hängen und Wechseln.
Für alle Pendelleuchten von ALIEN, BLUBB, ENTERPRISE, FLAPFLAP, LIQUID_LIGHT und DNA.

Patented connector system for ceiling mounting of pendant lamps: Easy installation and changing.
For all pendant lights of ALIEN, BLUBB, ENTERPRISE, FLAPFLAP, LIQUID_LIGHT and DNA.

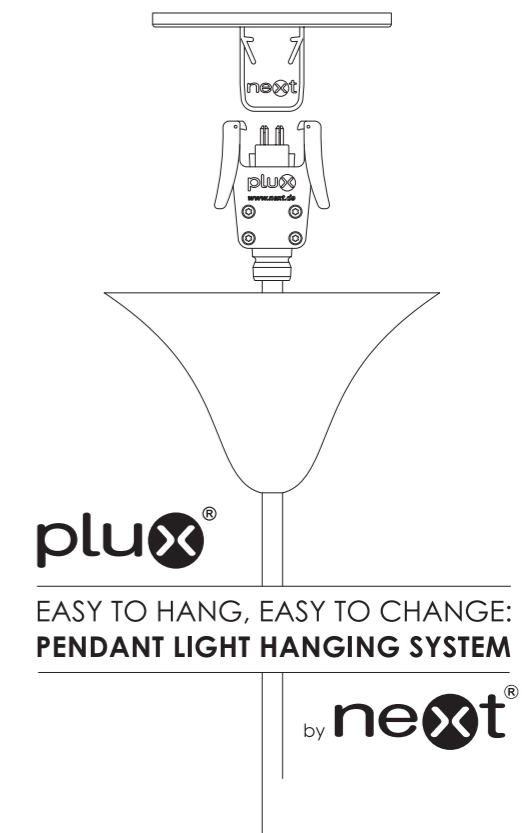
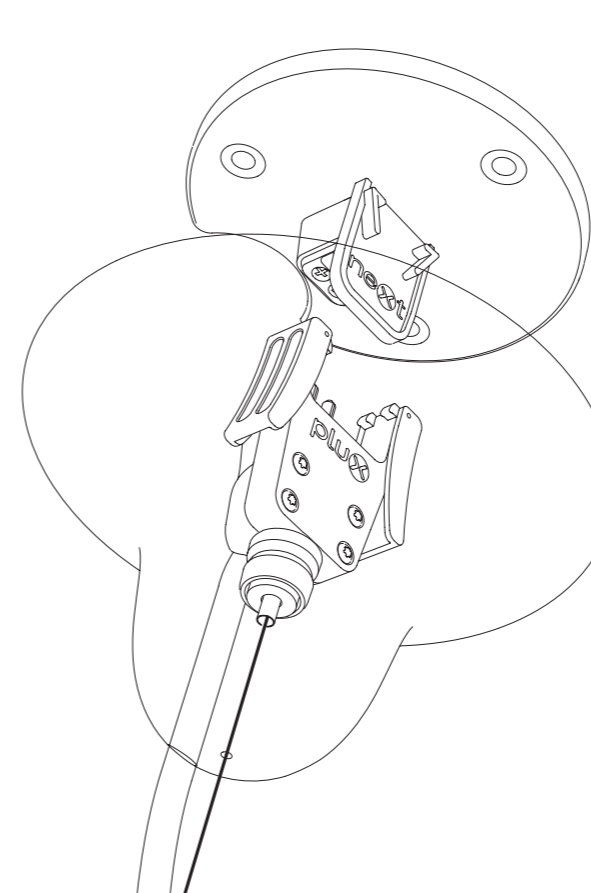

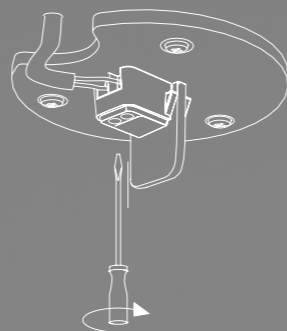

Attach base to ceiling.

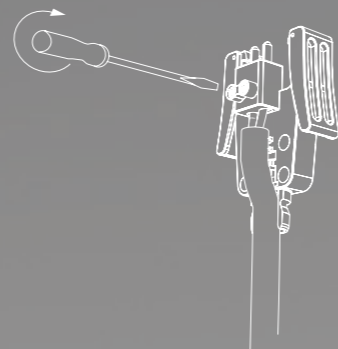

Attach **PLUX** plug to cable.

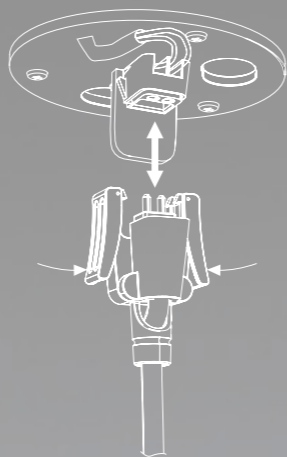

Click lamp on and off easily.





next[®]
lighting

next home collection e.K.

Tel.: +49 (0)221 71505-0

Fax: +49 (0)221 71505-999

info@next.design **www.next.design**

Grafik: www.buerofuerform.de

Fotos: u.a. D. Steets, A. Scherschel, C. Wortmann