













SWAROVSKI

THE 2018 COLLECTION



SWAROVSKI

PICTOGRAMS

#	Product Number	Número de producto	Numéro de produit	Produktnummer	Numero del prodotto	Номер продукта
	Dimensions	Dimensiones	Dimensions	Maße	Dimensioni	Габаритные размеры
	Crystal	Cristal	Cristal	Kristall	Cristallo	Хрусталь
	Finish	Acabado	Finition	Ausführung	Finitura	Отделка
	Bulb Type	Tipo De Bombilla.	Type De Lampe.	Leuchtmittel	Tipo Lampada.	Лампы
	Led Light Color	Color De Luz	Coloeur Lumière	Lichtfarbe	Colore Della Luce	Цвет при освещении
	Max. Height	Altura máx.	Hauteur max	Max. Höhe	Altezza max	Макс. высота
	Weight	Peso	Poids	Gewicht	Peso	Вес
*Bulb Included	Bulb Included	Incluido	Incluse	Inklusive	Lampadina inclusa	Включен
	Dimmable Dimmer Switch Not Included	Dimerizable Regulador De Luz No Esta Incluido	Variable Variateur De Lumière Pas Compris.	Dimmbar Dimmer-Schalter Nicht Inkludiert	Dimmerizable Regolatore Di Luminosità Non Incluso	С возможностью диммирования Диммер не входит
	Surface-Mounted Pendant Luminaire	Luminaria colgante monta- da en la superficie	Luminaire pendentif monté au plafond	Pendel-Aufbauleuchte	Lampada a sospensione	Подвесной светильник, монтаж на поверхности
	Surface-mounted ceiling luminaire	Luminaria de techo monta- da en la superficie	Planfonnier inclinable	Decken-Aufbauleuchte	Lampada a soffitto	Потолочный светильник, монтаж на поверхности
	Surface-Mounted Wall Luminaire	Luminaria de pared monta- da en la superficie	Applique murale montée en surface	Wand-Aufbauleuchte	Applique	Настенный светильник, монтаж на поверхности
CERT	Certification					
CUL	United States + Canada					
CE	International					
CCC	China					

CONTENTS

FYRA	2
GLISSANDO	10
VEGA	16
APPENDIX	19
SWAROVSKI LIGHTING WORLDWIDE	20



FYRA

—
Fyra enchants the beholder with pieces of perfectly faceted crystal peeking through a windowless lantern-like handmade metal frame. Large chunks of crystal catch and hold light from every angle, then release it into space, shredded into myriad flickering fragments of color. The collection offers single and triple pendants in several sizes as a focal point for any space.

—
Fyra bezaubert den Betrachter mit präzise facettiertem Kristall in einem handgefertigten Metallrahmen in blickdichter Laternenform. Die Oversize-Kristalle fangen das Licht aus jedem Blickwinkel ein und senden es in einem wahren Füllhorn der Farben zurück in den Raum. Als einfach oder dreifach gruppierte Hängeleuchte ziehen diese Edelversionen der neuen Linie alle Blicke auf sich.

—
Fyra cautiva al espectador con piezas de cristal perfectamente facetado que asoman a través de una estructura metálica sin ventanas similar a la de un farolillo. Sus grandes cristales capturan la luz desde todos los ángulos para luego volver a proyectarla en el espacio, descompuesta en un sinfín de centelleantes fragmentos de color. La colección ofrece luminarias colgantes dobles y triples, ideales como punto focal para cualquier espacio.

—
Fyra incanta gli spettatori con elementi di cristallo perfettamente sfaccettato che si affacciano da una cornice di metallo realizzata a mano che ricorda una lanterna senza finestre. Grossi cristalli catturano e trattengono la luce da ogni angolazione, per poi rilasciarla nello spazio, infranta nello sfarfallio di una miriade di frammenti di colore. La collezione offre lampade a sospensione singole e triple in diverse misure, come punto focale per ogni ambiente.

—
Fyra est un enchantement pour les yeux avec ses pièces en cristal parfaitement facetté qui affleurent sous une structure en métal confectionné à la main évoquant une lanterne sans fenêtres. De grands éléments en cristal accrochent et retiennent la lumière sous tous ses angles, puis la relâchent dans l'espace, découpée en une myriade de fragments de couleur ondoyants. La collection propose des suspensions simples et triples en plusieurs dimensions qui forment le point de mire d'un espace.

—
Fyra завораживает безупречно огранёнными кристаллами, которые проглядывают сквозь изготовленный вручную фонарь на металлическом каркасе без окон. Крупные кристаллы улавливают лучи со всех направлений и отражают их, озаряя пространство мириадами мерцающих разноцветных искр. В коллекции представлены одинарные и тройные подвесные светильники нескольких размеров. Они станут основным акцентом любого интерьера.



SQB711-WH1S



SQB610-BK1S



SQB510-WH1S



SQB411-BK1S

SQB710 | SQB711

ROD KITS
 3in/7.6cm
 6in/15.2cm
 9in/22.9cm
 12in/30.5cm
 21in/53.3cm

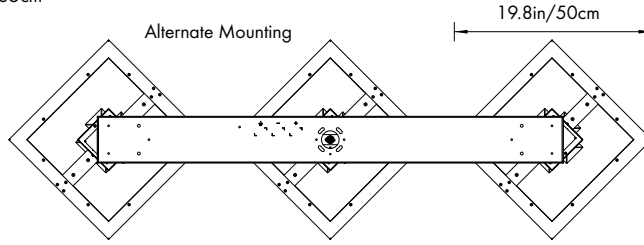
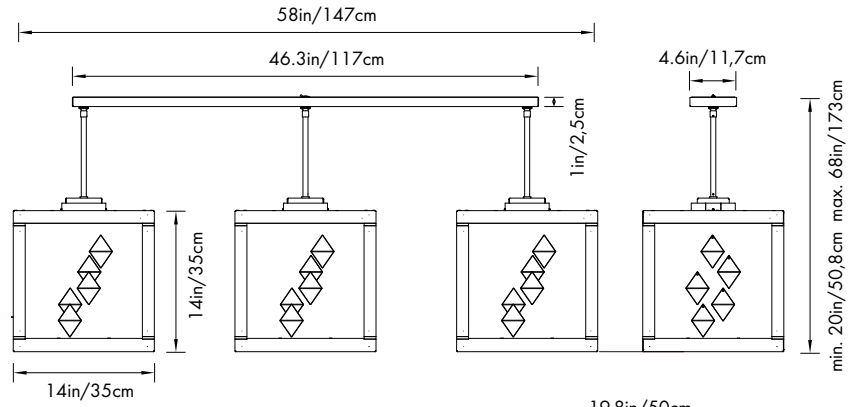

SQB610 | SQB611

ROD KITS
 3in/7.6cm
 6in/15.2cm
 9in/22.9cm
 12in/30.5cm
 21in/53.3cm

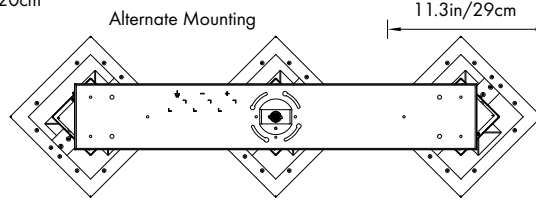
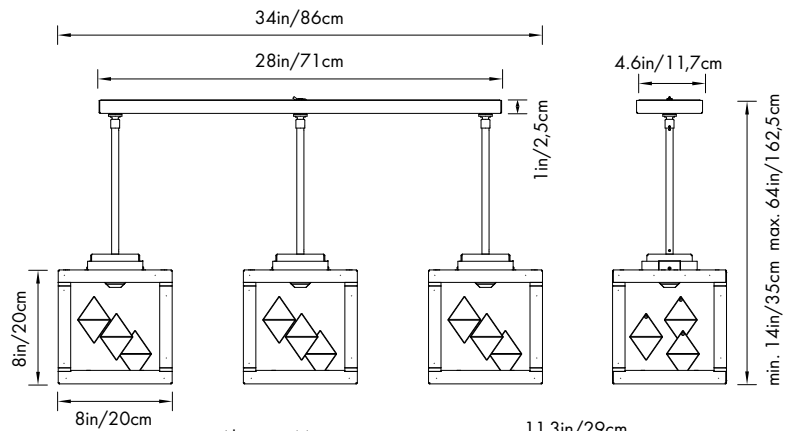

FYRA

LINE VOLTAGE

#	Type						max		CERT.
SQB710			Crystal (S)	3-LED 8max*	3000K	58 x 14 x 20 in 147 x 35 x 50.8 cm	68 in 173 cm	7.5 lbs 3.5 kg	CUL CE
SQB711				3-LED 8max*	4000K				
SQB610				3-LED 8max*	3000K	34 x 8 x 14 in 86 x 20 x 35 cm	64 in 162.5 cm	32 lbs 14.5 kg	
SQB611				3-LED 8max*	4000K				

*Bulbs Included

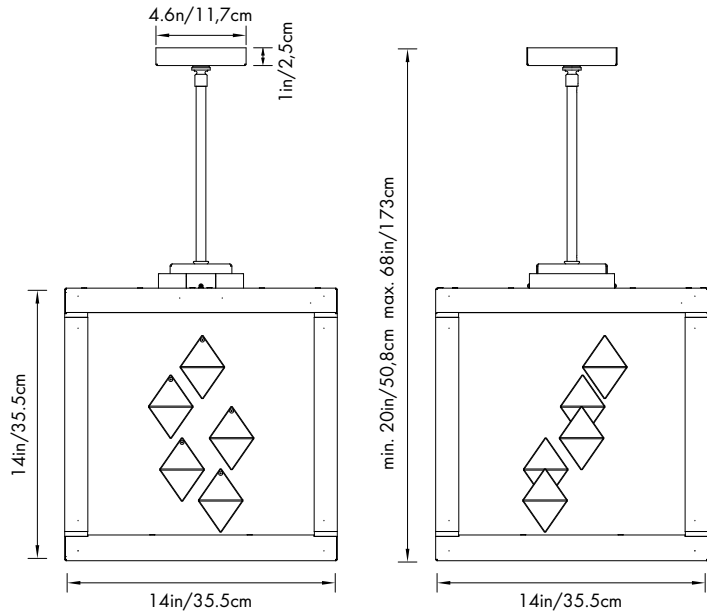

SQB510 | SQB511

ROD KITS
 3in/7.6cm
 6in/15.2cm
 9in/22.9cm
 12in/30.5cm
 21in/53.3cm

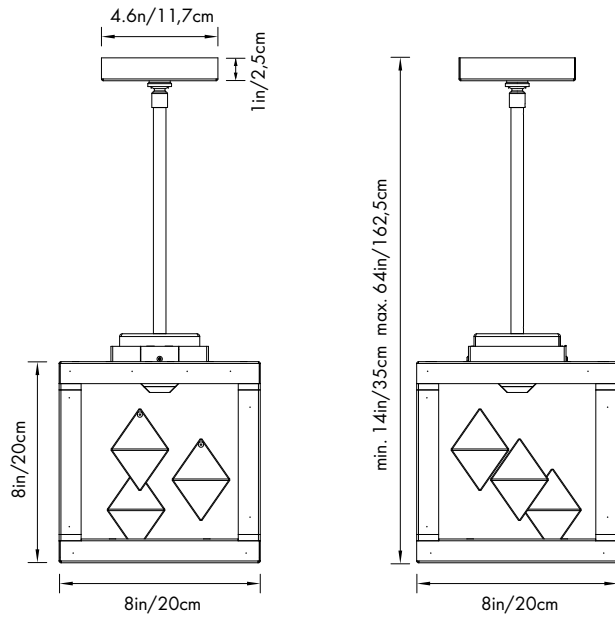

SQB410 | SQB411

ROD KITS
 3in/7.6cm
 6in/15.2cm
 9in/22.9cm
 12in/30.5cm
 21in/53.3cm

FYRA

LINE VOLTAGE

#	Type						max ↓		CERT.
SQB510	Black (-BK1) - With Gold Accent White (-WH1) - With Silver Accent	Crystal (S)		1-LED 8max*	3000K	14 x 14 x 14 in 35.5 x 35.5 x 35.5 cm	68 in 173 cm	19 lbs 8.5 kg	CUL CE
SQB511				4-LED 9max*	4000K				
SQB410				1-LED 8max*	3000K	8 x 8 x 8 in 20 x 20 x 20 cm	64 in 162.5 cm	10 lbs 4.5 kg	
SQB411				4-LED 9max*	4000K				

* Bulbs Included



SQB110BK1S



SQB211-WH1S

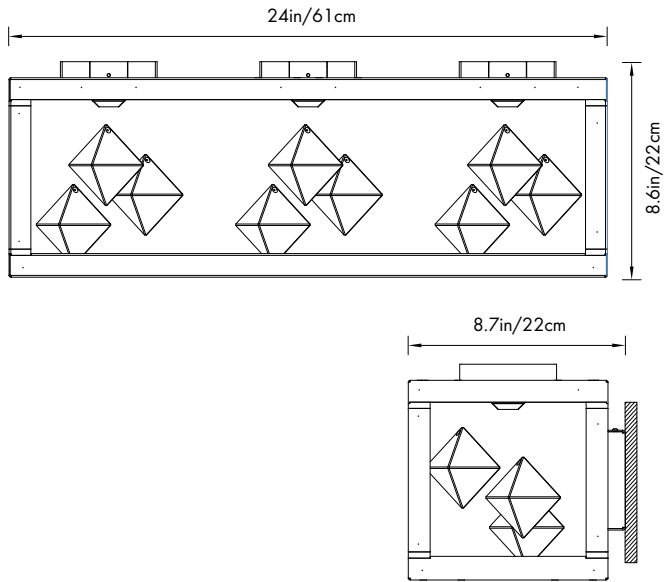



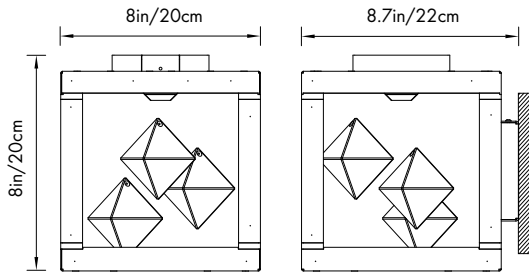



SQB210 | SQB211



SQB110 | SQB111

FYRA

LINE VOLTAGE 

#	Type							CERT.
SQB210	 Black (-BK1) - With Gold Accent White (-WH1) - With Silver Accent	Crystal (S)	3-LED 8max*	3000K	24 x 8.7 x 8.6 in 61 x 22 x 22 cm	22 lbs 10 kg	CUL CE	
SQB211			3-LED 8max*	4000K				
SQB110			1-LED 8max*	3000K	8 x 8.7 x 8 in 20 x 22 x 20 cm	11 lbs 5 kg		
SQB111			1-LED 8max*	4000K				

*Bulbs Included



STW411-5S1S (X3)

GLISSANDO

Named for glissando, an Italian term describing musical notes gliding upward and downward in perfect harmony, the crystal prisms in the Glissando collection glide from one to another creating a multi-layered stack of sparkling light. Interlocking planes and angles radiate bands of color as the crystal holds and reflects light from its twisted silhouette.

Genau wie Noten, die in perfekter Harmonie von einer Tonhöhe zur anderen gleiten, tanzen auch die Kristallprismen der Glissando Linie - benannt nach dem italienischen Begriff für das musikalische Phänomen - von einer Ebene zur nächsten und kreieren funkelndes Licht in einem spektakulären Lagenlook. Kristallelemente in verdrehten Konturen sorgen für einen herrlichen Tanz des Lichts, der in den schimmernden Farbbändern der miteinander verwobenen Ebenen, Flächen und Linien perfekt zur Geltung kommt.

Bajo el nombre de "glissando" – término en italiano que describe cómo las notas se "deslizan" en sentido ascendente y descendente en perfecta armonía– los prismas de cristal de la colección Glissando fluyen entre sí para crear un brillante efecto de luz multidimensional. Sus ángulos y planos interrelacionados irradian franjas de color mientras que el cristal captura y refleja la luz desde su silueta en espiral.

I prismi di cristallo della collezione Glissando, il cui nome indica la rapida successione scivolata delle note musicali verso l'alto o verso il basso in perfetta armonia, scorrono uno dopo l'altro creando sovrapposizioni a multistrato di luce scintillante. Piani e angoli intrecciati irradiano fasce di colore, mentre il cristallo cattura e riflette la luce dalla sua silhouette attorcigliata.

Baptisé ainsi en référence au glissando, un terme italien décrivant des notes musicales qui montent et descendent en parfaite harmonie, les prismes en cristal de la collection Glissando glissent de l'un à l'autre en créant un mille-feuille de lumière étincelante. Des plans et des angles imbriqués répandent des bandeaux de couleur alors que le cristal retient et reflète la lumière à partir de sa silhouette torsadée.

Glissando - итальянский термин, означающий абсолютно гармоничный плавный переход от низких нот к высоким и обратно. Кристалльные призмы в коллекции Glissando перетекают одна в другую, образуя наслоения сверкающего света. Соединённые между собой плоскости и углы лучатся радужными лентами. Кристаллы на скрученном силуэте восхитительно преломляют и отражают свет.



STW310-SS1S



STW411-SS1S

STW511-SS1S





STW710-SS1S



STW110-SS1S

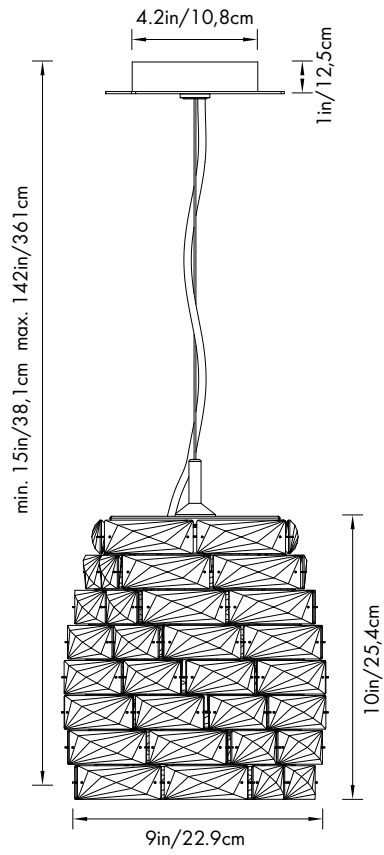

STW510 | STW511

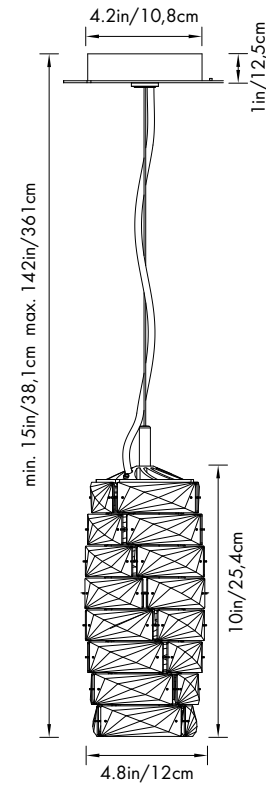

STW410 | STW411

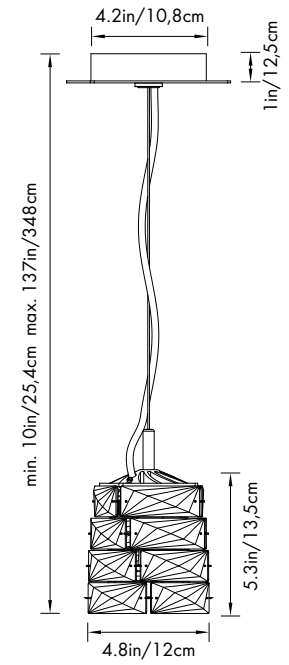

STW310 | STW311

GLISSANDO

LINE VOLTAGE

#	Type						max		CERT.
STW510				1-LED 12max*	3000K	9 x 9 x 10 in 22.9 x 22.9 x 25.4 cm	142 in 361 cm		CUL CE
STW511					4000K				
STW410				1-LED 6max*	3000K	4.8 x 4.8 x 10 in 12 x 12 x 25.4 cm	142 in 361 cm		
STW411					4000K				
STW310				3000K	4.8 x 4.8 x 5.3 in 12 x 12 x 13.5 cm	137 in 348 cm			
STW311				4000K					

*Bulbs Included

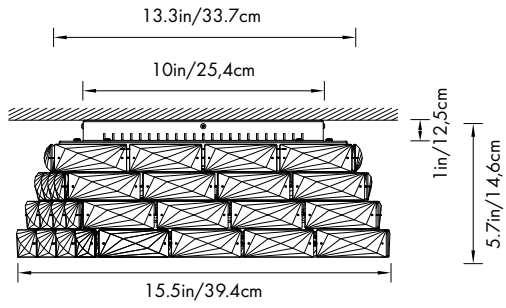

STW710 | STW711

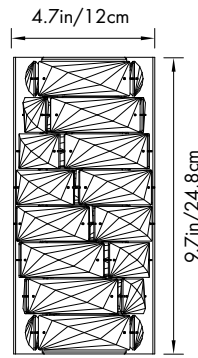



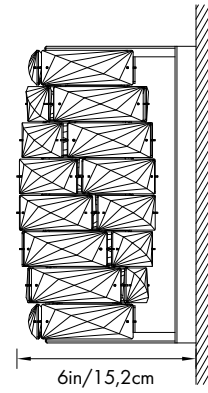





STW110 | STW111



GLISSANDO

LINE VOLTAGE 

#	Type							CERT.
STW710		Stainless Steel (SS1)	Crystal (S)	1-LED 10max*	3000K	15.5 x 15.5 x 5.7 in 39.4 x 39.4 x 14.6 cm	21 lbs 9.5 kg	CUL CE
STW711					4000K			
STW110				2-LED 4max*	3000K	4.7 x 6 x 9.7 in 12 x 15 x 24.8 cm	7 lbs 3 kg	
STW111					4000K			

*Bulbs Included



VEGA

—
Multidirectional light exudes from this crystal fixture. The textural casing brings charm and balance to every home's design. Those dedicated to a higher standard of craftsmanship appreciate the sheer versatility of its form and how it suits all spaces. Made with Swarovski's signature impeccable brilliance, as showcased in its Swarovski crystal accents.

—
Aus dieser Kristalleuchte flutet das Licht in alle Richtungen. Die charmante Halbkugel sorgt in jedem privaten Interior für eine ausgewogene Lichtverteilung. Die Anhänger meisterhafter Handwerkskunst wissen die vielseitigen Einsatzmöglichkeiten der Deckenleuchte zu schätzen, die sich nahtlos in alle Räume einfügt. Die Kristallakzente funkeln mit dem unverkennbar brillanten Glanz von Swarovski.

—
Una lámpara de cristal que irradia una luz multidireccional. Su estructura dimensional aporta encanto y equilibrio a cualquier diseño interior. Los amantes de la más exquisita técnica artesanal aprecian la increíble versatilidad en la forma de este aplique y su capacidad para adaptarse a cualquier espacio. Realizada por el brillo impecable de los emblemáticos cristales de Swarovski, tal como puede apreciarse en sus detalles de cristal.

—
Da questa lampada di cristallo emana una luce multidirezionale. L'involucro strutturale trasmette fascino ed equilibrio al design di ogni abitazione. Gli appassionati di standard più elevati di artigianato apprezzeranno la pura versatilità della forma della lampada da parete e il modo in cui si adatta a tutti gli spazi. Realizzata con l'impeccabile brillantezza caratteristica di Swarovski, come dimostrato dai suoi dettagli in cristallo Swarovski.

—
La lumière s'écoule de ce luminaire en cristal dans de multiples directions. Le revêtement texturé confère charme et équilibre à la décoration de chaque maison. Les passionnés du travail artisanal de très belle facture apprécieront la vraie polyvalence de la forme en applique et la manière dont elle s'adapte à tous les espaces. Elle est ornée de la brillance impeccable qui signe les produits Swarovski, comme le soulignent ses accents en cristal Swarovski.

—
Этот кристалльный светильник источает свет в разных направлениях. Текстурированный корпус внесёт в интерьер ноту очарования и баланса. Те, кто придаёт большое значение высокому стандарту мастерства, по достоинству оценят универсальный характер бра: оно прекрасно смотрится где угодно. Акценты из кристаллов Swarovski лучатся узнаваемым безупречным блеском.



SVA400 | A8992NR020031CRY



SVA400 | A8992NR030031CRY

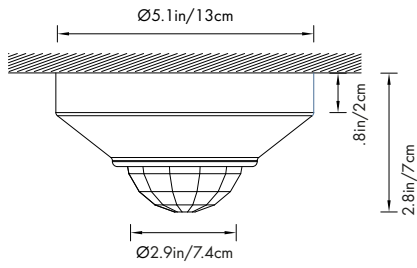

SVA400
 A8992NR020031CRY
 A8992NR020032CRY
 A8992NR020033CRY
 A8992NR030031CRY
 A8992NR030032CRY
 A8992NR030033CRY

SVA401
 A8992NR020131CRY
 A8992NR020132CRY
 A8992NR020133CRY
 A8992NR030131CRY
 A8992NR030132CRY
 A8992NR030133CRY

VEGA

LINE VOLTAGE

#	Type							CERT.	
SVA400	A8992NR020031CRY		Crystal (S)	1-LED 6max*	3000K	5.1 x 5.1 x 2.8 in 13 x 13 x 7 cm	7.5 lbs 3.5 kg	CUL	
	A8992NR020032CRY							Chrome (-CH1)	CE
	A8992NR020033CRY								CCC
	A8992NR030031CRY								CUL
	A8992NR030032CRY							Gold Plated (-GO1)	CE
	A8992NR030033CRY								CCC
SVA401	A8992NR020131CRY		Crystal (S)	1-LED 6max*	4000K	5.1 x 5.1 x 2.8 in 13 x 13 x 7 cm	7.5 lbs 3.5 kg	CUL	
	A8992NR020132CRY							Chrome (-CH1)	CE
	A8992NR020133CRY								CCC
	A8992NR030131CRY								CUL
	A8992NR030132CRY							Gold Plated (-GO1)	CE
	A8992NR030133CRY								CCC

* Bulbs Included

APPENDIX

FINISH OVERVIEW



BK1 - Black



CH1 - Chrome



Gold Plated



SS1 - Stainless Steel



WH1 - White

CRYSTAL OVERVIEW



S - Crystal
CL - Clear (CRY)

SWAROVSKI LIGHTING WORLDWIDE

NORTH AND SOUTH AMERICA

Swarovski Lighting, Ltd.
61 Industrial Boulevard
Plattsburgh, New York 12901-1908
USA
Tel. +1 800 836 1892 or +1 518 563 7500
Fax +1 518 563 4228
lighting.na@swarovski-lighting.com

EUROPE

Swarovski International Distribution AG
Swarovski Lighting
Dröschstrasse 15
FL-9495 Triesen
Principality of Liechtenstein
Tel. +423 399 5656
Fax +423 399 5666
lighting.europe@swarovski.com

AUSTRIA

Tel. +43 5224 500 5656
Fax +43 5224 500 5666

FRANCE

Tel. +33 1 44 76 15 53
Fax +33 1 44 76 15 54

GREAT BRITAIN

Tel. +44 845 607 0341
Fax +44 845 607 0342

AFRICA / MIDDLE EAST / INDIA

Swarovski Middle East FZE
Swarovski Lighting
P.O. Box 17128
Jebel Ali Free Zone, Junction 6
Dubai UAE
Tel. +971 4 881 65 62
Fax +971 4 881 56 23
lighting.me@swarovski.com
lighting.india@swarovski.com

AUSTRALIA / ASIA PACIFIC

Swarovski Singapore Trading PTE LTD.
Swarovski Lighting
2 Alexandra Road
Unit No. 03-01 Delta House
159919, Singapore
Tel: +65 6661 6393
Fax: +65 6274 8177
Email: lighting.ap@swarovski.com

Swarovski (Shanghai) Trading Co., Ltd.
Swarovski Lighting
Rm. 1601 No. 168 Xizang Rd(M),
Shanghai, China
Tel: +86 21 23069888
Fax: +86 21 63727405
Email: lighting.ap@swarovski.com

You can find worldwide sales companies and sales representatives here:
SWAROVSKI-LIGHTING.COM

PUBLISHER: Swarovski Lighting, Ltd., Plattsburgh, New York

© 2018 Swarovski Lighting, Ltd., Plattsburgh, New York

Art Direction and Performance: Swarovski Lighting Ltd., Plattsburgh, New York

All rights reserved. The publication, transfer, or any other form of copying contents or parts thereof, in any form, is forbidden, unless previously agreed in writing by Swarovski. We reserve the right to change prices and technical details. We will not be held responsible for errors in printing or terminology. Terms and conditions apply. With the issuing of this pricelist/catalog, all previous prices/information cease to apply. We will be happy to provide information on the country-specific availability of the items described upon request. All measurements given in cm/inch. The currently valid General Terms and Conditions can be found on our website
SWAROVSKI-LIGHTING.COM

Dirección y ejecución artística: Swarovski Lighting Ltd., Plattsburgh, New York

Todos los derechos reservados. Queda prohibida toda forma de publicación, transmisión, así como cualquier tipo de reproducción de los contenidos o partes de los mismos, a menos que Swarovski lo haya autorizado previamente por escrito. Nos reservamos el derecho a realizar modificaciones de precios, así como modificaciones técnicas. No asumimos la responsabilidad de errores de impresión o redacción. Se aplicarán las condiciones comerciales generales. Con la publicación de la presente lista de precios y catálogos, todos los precios anteriores e información dejarán de ser aplicados. Si lo solicita, estaremos encantados de informarle sobre la disponibilidad específica para cada país de la gama de productos mostrada. Todas las medidas se indican en cm/inch. Puede encontrar las condiciones comerciales generales actualmente vigentes en nuestra página web SWAROVSKI-LIGHTING.COM

Mise en page et conception : Swarovski Lighting Ltd., Plattsburgh, New York

Tous droits réservés. Toute publication, communication ainsi que toute autre forme de reproduction, même partielle, du contenu est interdite, sous quelque forme que ce soit, sans le consentement écrit préalable de Swarovski. Sous réserve de modifications de prix et de modifications techniques. Aucune responsabilité n'est assumée pour les erreurs d'impression ou typographiques. Les conditions générales de vente et de livraison s'appliquent. Avec la publication de cette liste de prix / de ce catalogue, tous les prix antérieurs / toutes les informations antérieures cessent de s'appliquer. C'est avec plaisir que nous vous informons sur demande de la disponibilité dans les différents pays de l'assortiment présenté. Toutes les dimensions sont en cm/inch. Vous trouverez les conditions générales de vente et de livraison actuellement en vigueur sur notre site Web :
SWAROVSKI-LIGHTING.COM

Konzeption und Umsetzung: Swarovski Lighting, Ltd., Plattsburgh, New York

Alle Rechte vorbehalten. Die Veröffentlichung, Übertragung sowie jede andere Art der Vervielfältigung der Inhalte oder von Teilen hiervon ist in jeder Form verboten, wenn Swarovski nicht vorher schriftlich zustimmt. Preisänderungen sowie technische Änderungen vorbehalten. Keine Haftung für Druck- oder Satzfehler. Es gelten die Allgemeinen Geschäftsbedingungen. Mit Erscheinen dieser Preisliste/dieses Kataloges verlieren alle bisherigen Preise/Angaben ihre Gültigkeit. Über die länderspezifische Verfügbarkeit des dargestellten Sortiments informieren wir gerne auf Anfrage. Alle Maßangaben in cm/inch. Bitte kontaktieren Sie unseren Customer Service um die aktuell gültigen allgemeinen Geschäftsbedingungen zu erhalten.

Impaginazione e concezione: Swarovski Lighting, Ltd., Plattsburgh, New York

Tutti i diritti riservati. Sono vietate la diffusione, la trasmissione, così come ogni altro tipo di riproduzione del contenuto del presente o di una sua parte, in qualsiasi forma, in mancanza di autorizzazione scritta fornita da Swarovski. L'azienda si riserva di apportare variazioni di prezzo e tecniche. Si declina ogni responsabilità per eventuali errori di stampa o tipografici. Si applicano le condizioni commerciali generali. Con la pubblicazione di questo listino prezzi/catalogo, tutti i precedenti prezzi/informazioni perdono validità. Informazioni sulla disponibilità nei singoli paesi degli assortimenti raffigurati saranno fornite su richiesta. Per i termini e le condizioni attuali si prega di contattare il servizio clienti.

Руководство художественными проектами и их реализация: Swarovski Lighting, Ltd., Plattsburgh, New York

Авторские права защищены. Публикация, передача, а также любой вид размножения содержимого или его частей в любой форме запрещено при отсутствии предварительного письменного согласия компании Swarovski. Допускаются изменения цены и изменения в технической части. Ответственность не несет за опечатки или ошибки в наборе. Действуют „Общие коммерческие условия“. С выпуском этого прайс-листа/каталога, предыдущие прайс-листы/информации прекращают свое действие. Анализи товаров в представленном в конкретной стране ассортименте мы готовы предоставить по запросу. Все размеры указаны в см/инч. Имеющие в настоящий момент силу. По текущим правилам и условиям, пожалуйста, обратитесь к представителю Отдела по работе с клиентами.

NOTES



SWAROVSKI-LIGHTING.COM